

## **POLICY ISSUE** **(Information)**

October 9, 2013

SECY-13-0112

FOR: The Commissioners

FROM: Mark A. Satorius  
Executive Director for Operations

SUBJECT: CONSEQUENCE STUDY OF A BEYOND-DESIGN-BASIS  
EARTHQUAKE AFFECTING THE SPENT FUEL POOL FOR A U.S.  
MARK I BOILING-WATER REACTOR

### PURPOSE:

The purpose of this paper is to provide to the Commission the final report of the enclosed study entitled, "Consequence Study of a Beyond-Design-Basis Earthquake Affecting the Spent Fuel Pool for a U.S. Mark I Boiling Water Reactor." This paper completes the action directed by the Staff Requirements Memorandum (SRM) dated July 16, 2012 (ADAMS Accession No.: ML121980043). This paper does not address any new commitments or resource implications.

### BACKGROUND AND SUMMARY OF STUDY RESULTS:

The March 11, 2011, Tohoku earthquake and subsequent tsunami in Japan resulted in significant damage to the Fukushima Dai-ichi nuclear power station. Although the spent fuel pools (SFPs) and the spent fuel assemblies stored in the pools remained intact, the event led to questions about the safe storage of spent fuel and whether the U.S. Nuclear Regulatory Commission (NRC) should require expedited transfer of spent fuel from pools to dry cask storage at U.S. nuclear power plants.

The purpose of the enclosed study is to help the agency determine if accelerated transfer of spent fuel from the spent fuel pool to dry cask storage significantly reduces risks to public health and safety. The study provides consequence estimates of a hypothetical spent fuel pool

CONTACT: Don Algama, RES/DSA  
301-251-7940

accident initiated by a low-likelihood seismic event at a reference plant based on the Peach Bottom BWR Mark I spent fuel pool. The study compares high-density and low-density loading conditions and assesses the benefits of post 9/11 mitigation measures.

This study shows the likelihood of a radiological release from the spent fuel after the analyzed severe earthquake at the reference plant to be very low (about 1 time in 10 million years or lower). For the hypothetical releases studied, the study predicted no early fatalities attributable to radiation exposure and individual latent cancer fatality risks are low; however, the study suggested that extensive protective actions may be needed for both the high and low density pool loadings.

#### DISCUSSION:

Various risk studies (most recently NUREG-1738, "Technical Study of Spent Fuel Pool Accident Risk at Decommissioning Nuclear Power Plants," issued February 2001 [ADAMS Accession No. ML010430066]) have shown that storage of spent fuel in a high-density configuration in SFPs is safe and that the risk to public health and safety from a SFP accident is very low. In response to the events of September 11, 2001, the NRC undertook security assessments of spent fuel storage in pools and casks. Moreover, in conjunction with these post-9/11 security assessments, the NRC issued an order—later codified in Title 10 of the *Code of Federal Regulations*, Section 50.54(hh)(2)—that requires reactor licensees to develop and implement guidance and strategies intended, in part, to maintain or restore SFP cooling capabilities following certain beyond-design-basis events (including explosions and fires). The agency also reviewed the safety of spent fuel stored in high-density configurations in a response to Petition for Rulemaking (PRM)-51-10 and PRM-51-12 as well as the revision to NUREG-1437, Revision 1, "Generic Environmental Impact Statement for License Renewal of Nuclear Plants - Draft Report for Comment," issued July 2009 (the final NUREG is expected to be published soon).

The staff performed the enclosed consequence study to continue NRC's examination of the risks and consequences of postulated spent fuel pool accidents. This study presents detailed analyses using state-of-the-art, validated, deterministic methods and assumptions as well as probabilistic insights where practical. Previous studies have shown that earthquakes present the dominant risk for spent fuel pools. Therefore, this analysis considered a severe earthquake that would be expected to occur once in 60,000 years with ground motion stronger than the maximum earthquake used for the design basis for the reference plant. The staff considers the ground motion used in this study more challenging for the spent fuel pool structure than that experienced at the Fukushima Dai-ichi nuclear power plant from the earthquake that occurred off the coast of Japan on March 11, 2011. That earthquake did not result in any spent fuel pool leaks. This study's results for the specific reference plant and earthquake analyzed are consistent with past studies' conclusions that spent fuel pools are likely to withstand severe earthquakes without leaking. The regulatory analysis included in the study indicates that expediting movement of spent fuel from the pool does not provide a substantial safety enhancement for the reference plant.

The staff presented the report to the Advisory Committee on Reactor Safeguards (ACRS) on July 9, 2013. The ACRS subsequently submitted a letter to the Commission on July 18, 2013 (ML13198A433), and the NRC provided a response on August 14, 2013 (ML13205A242). The NRC released a draft report to the public in a press release on June 24, 2013 (ML13175A104), and published a *Federal Register* notice (FRN) on July 2, 2013, announcing a 30-day public comment period. The report received responses from 14 different public commenters.

Appendix E of the enclosed report contains those comments and the staff's responses. None of the comments or responses has necessitated making substantial changes to the report.

One of the objectives of the current study is to inform the NRC's Japan Lessons Learned Tier 3 activities. The staff will use the results of the study to inform a broader regulatory analysis of the spent fuel pools at U.S. operating nuclear reactors.

Please note that the staff intends to proceed with making the attached report public, and the report will be subsequently published as a NUREG.

COORDINATION:

The Office of the General Counsel has reviewed the draft study and has no legal objections. The Office of the Chief Financial Officer reviewed this paper for resource implications and has no objections.

*/RA/*

Mark A. Satorius  
Executive Director  
for Operations

Enclosure:  
As stated

cc: SECY  
OCA  
OGC  
OPA  
CFO

**Consequence Study of a Beyond-Design-Basis Earthquake Affecting the Spent Fuel Pool  
for a U.S. Mark I Boiling Water Reactor**

**October 2013**

Project Manager

Don Algama  
Katie Wagner (former)

Authors

Andrew Barto  
Y. James Chang  
Keith Compton  
Hossein Esmaili  
Donald Helton  
Andrew Murphy  
Andrew Nosek  
Jose Pires  
Fred Schofer  
Brian Wagner

Office of Nuclear Regulatory Research  
US Nuclear Regulatory Commission





## FOREWORD

U.S. nuclear power plants are required to be designed with appropriate consideration of the most severe natural phenomena (e.g. floods, earthquakes, tornadoes) historically reported for their location and surrounding regions, with sufficient margin, to ensure that important safety functions can be performed. As part of our mission to protect public health and safety, the U.S. Nuclear Regulatory Commission (NRC) uses advanced computer modeling and other techniques to study more severe, and highly unlikely, events that go beyond what the plant was designed to withstand to estimate risk to the public and to explore and ensure safety margins.

On March 11, 2011, the Tohoku earthquake and subsequent tsunami in Japan resulted in significant damage to the site of the Fukushima Dai-ichi nuclear power station. Although the spent fuel pools and the used fuel assemblies stored in the pools remained intact at the plant, the event led to questions about the safe storage of spent fuel and whether the NRC should require the expedited transfer of spent fuel from pools to dry cask storage containers at U.S. nuclear power plants.

This report documents the Office of Nuclear Regulatory Research's consequence study that continues our examination of the risks and consequences of postulated spent fuel pool accidents. A spent fuel pool's robust concrete structure and stainless steel liner keep more than 20 feet of water above the spent fuel stored within it ensuring ample cooling for the spent fuel and adequate radiation shielding for plant personnel. About every two years, some used fuel is removed from the reactor and placed into the spent fuel pool. The used fuel most recently removed from a reactor is radiologically and thermally "hot". The hot fuel is distributed throughout the pool and is surrounded by older, cooler used fuel. After used fuel has cooled in the spent fuel pool for more than about five years, it has radiologically decayed such that it can be moved to dry storage casks for longer term storage.

This study compared potential accident consequences from a pool nearly filled with spent fuel and a pool in which fuel that has cooled sufficiently has been removed. The staff first evaluated whether a severe, though unlikely, earthquake would damage the spent fuel pool to the point of leaking. In order to assess the consequences that might result from a spent fuel pool leak, the study assumed seismic forces greater than the maximum earthquake reasonably expected to occur at the reference plant location. The NRC expects that the ground motion used in this study is more challenging for the spent fuel pool structure than that experienced at the Fukushima Daiichi nuclear power plant from the earthquake that occurred off the coast of Japan on March 11, 2011. That earthquake did not result in any spent fuel pool leaks. In the small likelihood that such an extreme earthquake caused a leak, the staff then analyzed where the leak would be expected, the size of the leak, and how the spent fuel could overheat and potentially release radioactive material into the environment. Finally, the staff analyzed what the public health and environmental effects of a radiological release would be in the area surrounding the plant. In order to estimate the hypothetical consequences, the staff analyzed scenarios where some preplanned and improvised mitigative actions by the emergency response organization were either not successful or not implemented.

The study results for the specific reference plant and earthquake analyzed are consistent with past studies' conclusions that spent fuel pools are likely to withstand severe earthquakes without leaking. Past studies considered a wider range of earthquakes than this study. In the unlikely situation that a leak occurs, this study shows that for the scenarios and spent fuel pool studied, spent fuel is only susceptible to a radiological release within a few months after the fuel

is moved from the reactor into the spent fuel pool. After that time, the spent fuel is coolable by air for at least 72 hours. This study shows the likelihood of a radiological release from the spent fuel after the analyzed severe earthquake at the reference plant to be about one time in 10 million years or lower. If a leak and radiological release were to occur, this study shows that the individual cancer fatality risk for a member of the public is several orders of magnitude lower than the Commission's Quantitative Health Objective of two in one million ( $2 \times 10^{-6}$ /year). For such a radiological release, this study shows public and environmental effects are generally the same or smaller than earlier studies.

The Office of Nuclear Reactor Regulation's regulatory analysis for this study indicates that expediting movement of spent fuel from the pool does not provide a substantial safety enhancement for the reference plant. The NRC plans to use the insights from this analysis to inform a broader regulatory analysis of the spent fuel pools at all U.S. operating nuclear reactors as part of its Japan Lessons-learned Tier 3 plan. The NRC continues to believe, based on this study and previous studies that spent fuel pools continue to provide adequate protection of public health and safety.

## **ABSTRACT**

The U.S. Nuclear Regulatory Commission performed this consequence study to continue its examination of the risks and consequences of postulated spent fuel pool accidents. The study provides publicly available consequence estimates of a hypothetical spent fuel pool accident initiated by a low likelihood seismic event at a specific reference plant. The study compares high-density and low-density loading conditions and assesses the benefits of post 9/11 mitigation measures. Past risk studies have shown that storage of spent fuel in a high-density configuration is safe and risk of a large release due to an accident is very low. This study's results are consistent with earlier research conclusions that spent fuel pools are robust structures that are likely to withstand severe earthquakes without leaking. The NRC continues to believe, based on this study and previous studies that high density storage of spent fuel in pools protects public health and safety. The study's results will inform a broader regulatory analysis of the spent fuel pools at U.S. nuclear reactors as part of the Japan Lessons-learned Tier 3 plan.

## ACKNOWLEDGEMENTS

The authors would like to acknowledge the following individuals who directly or indirectly contributed to this work. The following individuals directly contributed in the form of analyses and support:

Jon Ake, U.S. Nuclear Regulatory Commission  
Jeffrey Mitman, U.S. Nuclear Regulatory Commission  
Antonios Zoulis, U.S. Nuclear Regulatory Commission  
Christopher Cahill, U.S. Nuclear Regulatory Commission  
Nate Bixler, Sandia National Laboratories  
Hernando Candra, U.S. Nuclear Regulatory Commission  
Ian Gauld, Oak Ridge National Laboratory  
Andrew Goldmann, Sandia National Laboratories  
Larry Humphries, Sandia National Laboratories  
Joe Jones, Sandia National Laboratories  
Thomas Miler, Oak Ridge National Laboratory  
Bruce Patton, Oak Ridge National Laboratory  
Joel Piper, Rotatee from the U.S. Department of Homeland Security  
Randy Sullivan, U.S. Nuclear Regulatory Commission  
Kenneth C. Wagner, Dycoda, LLC

The following individuals from other offices of the U.S. Nuclear Regulatory Commission (NRC) provided support and advice throughout the conduct of the study:

Eric Bowman	John Hughey	Wayne Schmidt	Kent Wood
Rick Ennis	Steven Jones	Eric Schrader	Adam Ziedonis
Sam Hansell	Eric Powell	Bret Tegeler	

Finally, the authors wish to acknowledge the guidance and support of NRC management, and in particular Brian Sheron, Director of the Office of Nuclear Regulatory Research, who provided the initial direction for the study.

## EXECUTIVE SUMMARY

The U.S. Nuclear Regulatory Commission performed this consequence study to continue its examination of the risks and consequences of postulated spent fuel pool accidents. Pertinent research conducted over the last several decades is summarized in NUREG-1353, "Regulatory Analysis for the Resolution of Generic Issue 82, Beyond Design Basis Accidents in Spent Fuel Pools, April 1989; in NUREG/CR-6451, "A Safety and Regulatory Assessment of Generic BWR [boiling water reactor] and PWR [pressurized water reactor] Permanently Shutdown Nuclear Power Plants," April 1997 and in NUREG-1738, "Technical Study of Spent Fuel Pool Accident Risk at Decommissioning Nuclear Power Plants," February 2001. The purpose of this consequence study was to determine if accelerated transfer of older, colder spent fuel from the spent fuel pool at a reference plant to dry cask storage significantly reduces risks to public health and safety. The specific reference plant used for this study is a GE Type 4 BWR with a Mark I containment.

The study's results will help inform a broader regulatory analysis of the spent fuel pools at U.S. nuclear reactors as part of the Japan Lessons-learned Tier 3 plan. This study's results are consistent with earlier research studies' conclusions that spent fuel pools are robust structures that are likely to withstand severe earthquakes without leaking cooling water and potentially uncovering the spent fuel. The study shows the likelihood of a radiological release from the spent fuel after the analyzed severe earthquake at the reference plant to be about one time in 10 million years or lower. In addition, the regulatory analysis included with this study does not support accelerated spent fuel transfer to casks for the reference plant. .

This study presents detailed analyses using state-of-the-art, validated, deterministic methods and assumptions, as well as probabilistic insights where practical. Previous studies have shown that earthquakes present the dominant risk for spent fuel pools, so this analysis considered a severe earthquake with ground motion stronger than the maximum earthquake reasonably expected to occur for the reference plant. The NRC expects that the ground motion used in this study is more challenging for the spent fuel pool structure than that experienced at the Fukushima Daiichi nuclear power plant from the earthquake that occurred off the coast of Japan on March 11, 2011. That earthquake did not result in any spent fuel pool leaks. This beyond-design-basis earthquake severity was selected to challenge the spent fuel pool integrity. The study considered two spent fuel configurations:

- A relatively full pool where the hottest spent fuel assemblies are surrounded by four cooler fuel assemblies in a 1x4 pattern throughout the pool (referred to as the high-density loading scenario), and;
- A minimally loaded pool where all spent fuel with at least 5 years of pool cooling has been removed so the hottest fuel assemblies are surrounded by additional water (referred to as the low-density loading scenario).

Limited sensitivity analyses of a 1x8 spent fuel configuration and a uniform configuration were also performed to better understand the potential effect of spent fuel configurations on the results.

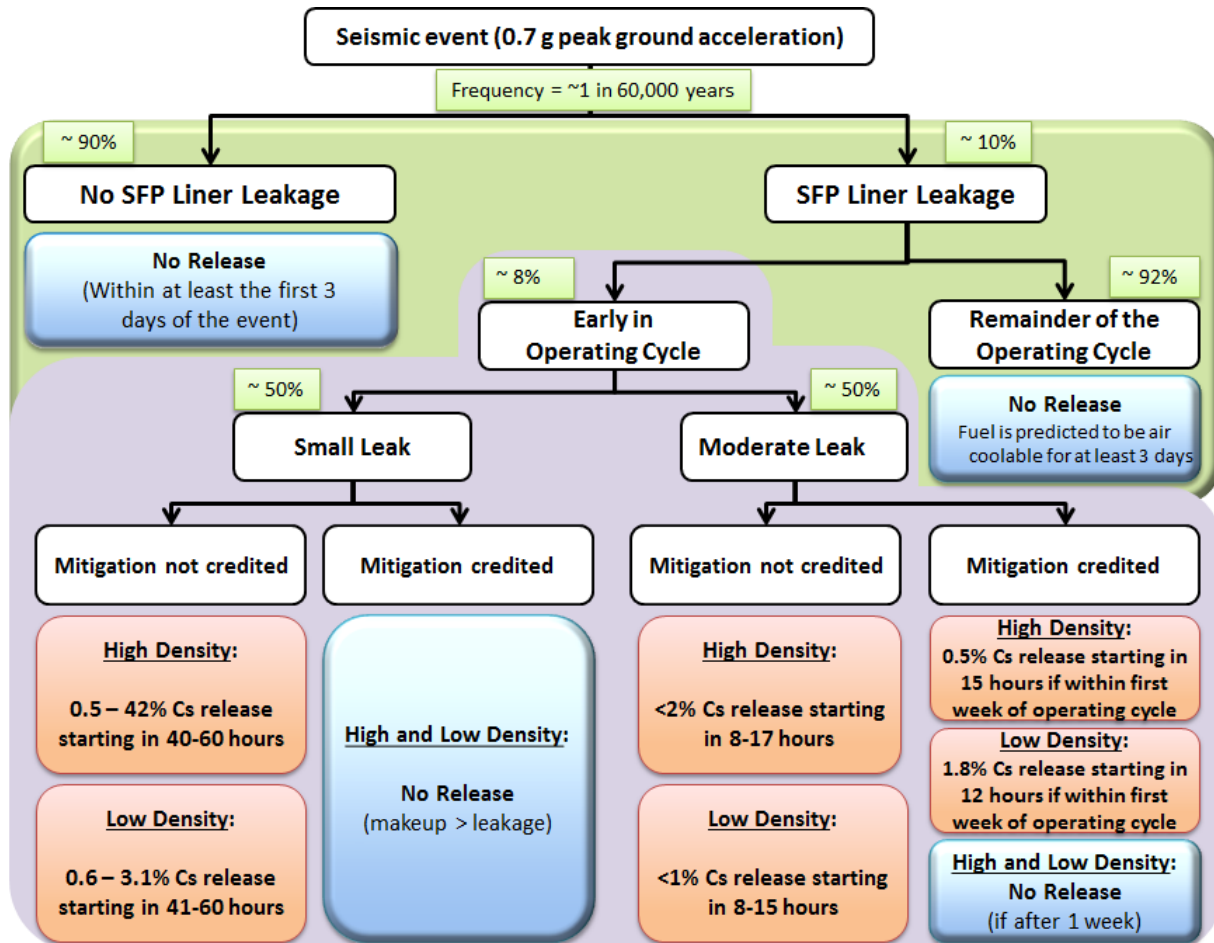
Additionally, the study evaluated the potential benefits of strategies required in Title 10, Code of Federal Regulations (10 CFR), Part 50.54 (hh)(2) following the September 11, 2001, attacks.

These “mitigation measures” are intended to maintain spent fuel pool cooling in the event of a loss of large areas of the plant due to explosions or fire.

The study evaluated 10 CFR 50.54(hh)(2) mitigation measures by analyzing each scenario twice – with and without credit for mitigation. The study shows that successful mitigation reduces the likelihood of a release. The likelihood of a spent fuel pool release was equally low for both high- and low-density fuel loading. This is because high- and low-density fuel loading contains the same amount of new, hotter spent fuel recently moved from the reactor to the spent fuel pool. In the unlikely event of an earthquake-induced spent fuel pool leak, the likelihood of fuel heatup leading to a release was more strongly affected by the fuel loading pattern rather than the total amount of fuel in the pool. In other words, the use of favorable fuel patterns such as the 1x4 pattern promotes natural circulation air coolability and reduces the likelihood of a release from a completely drained pool. Analysis also shows that for the scenarios and spent fuel pool studied, spent fuel is only susceptible to a radiological release within a few months after the fuel is moved from the reactor into the spent fuel pool. After that time, the spent fuel is coolable by air for at least 72 hours.

The study considered scenarios where some preplanned and improvised mitigative actions were either not successful or not implemented before three days, at which time the analysis was terminated. In addition to the 10 CFR 50.54(hh)(2) mitigation measures, the site emergency response organization would request support from the offsite response organizations to implement improvised additional mitigative measures, such as pumping water into the spent fuel pool using a fire truck. Analysis of these additional mitigative measures was beyond the scope of this study. Additionally, this study does not consider the post-Fukushima mitigation required by NRC in Orders EA-12-051 and EA-12-049 and currently being implemented by all operating U.S. nuclear power plants which should serve to further reduce spent fuel pool accident risk by increasing the capability of nuclear power plants to mitigate beyond-design-basis external events.

Figure ES-1 illustrates the study results in terms of the likelihood of a leak and magnitude of release from the spent fuel pool (SFP) for the severe, low likelihood earthquake considered in this study.



Note: The low-density pool has about 1/3 of Cs-137 inventory compared to high-density pool. Early in the operating cycle refers to early time after shutdown.

**Figure ES-1: Likelihood of a leak and magnitude of releases from beyond design basis earthquake**

This study considered a severe earthquake expected to occur once in 60,000 years; the pool is expected to remain intact during more likely, less severe earthquakes. The structural analysis of the pool shows the spent fuel pool in this study has a 90% probability of surviving the severe earthquake with no liner leakage (or conversely, a 10% probability of damaging the liner at the SFP wall/floor junction such that leakage will occur). The specific conditions for liner failure vary according to site conditions and spent fuel pool design. NUREG-1353 predicted the likelihood of liner failure from all potential earthquakes to be between about two and six times in a million years. NUREG-1738 predicted the likelihood of liner failure from all potential earthquakes to be between about two times in a million years and two times in 10 million years. This study considered an earthquake with ground motion roughly four to eight times stronger than that used in the plant design and predicted a liner failure likelihood of about two times in a million years.

The study examined how an accident is expected to proceed if the pool liner is damaged, concluding that pool leaks are somewhat less likely to release radioactive material to the environment than in previous studies. Depending on the size of the pool liner leak, releases could start anywhere from eight hours to several days after the leak starts assuming 10 CFR 50.54(hh)(2) mitigation measures are unsuccessful. In the event of an earthquake, releases are considered very unlikely for several reasons:

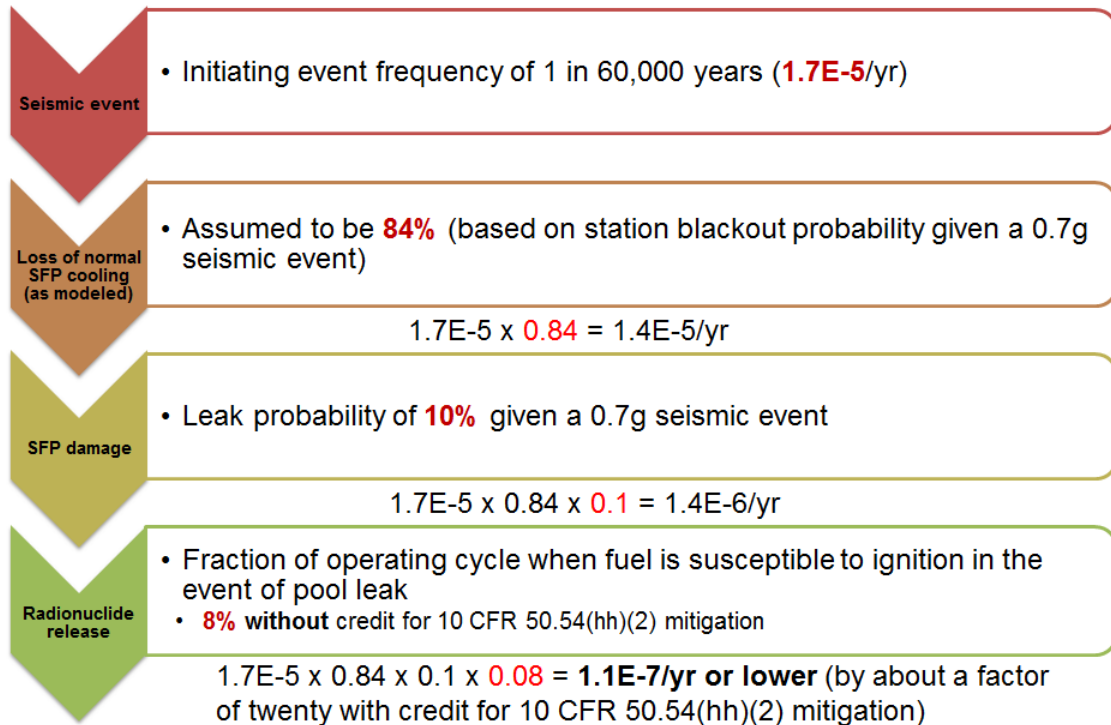


- The study finds liner damage is the only way to cause a radiological release in less than 3 days for the scenarios and spent fuel pool studied. Other possible outcomes provide time to prevent a release by taking emergency actions. This is consistent with earlier studies.
- The time period of susceptibility for a release of radioactive materials during the operating cycle is short. This study's detailed accident progression modeling differs from earlier work in showing that for the severe earthquake analyzed, draining the pool after liner failure is less likely to lead to a release. Because spent fuel can be effectively cooled by water, steam, or air, the likelihood of fuel overheating to the point of radiological release depends on several factors: how much residual heat the fuel generates, the fuel loading pattern, and the timing, location, and size of the liner leakage. If 10 CFR 50.54(hh)(2) mitigation measures aren't successful, releases could occur the first few months after the fuel came out of the reactor (or 8% of the reactor's two-year operating cycle). If 10 CFR 50.54(hh)(2) mitigation measures are successful, releases could only occur the first several days after the fuel came out of the reactor (a factor of twenty reduction in the likelihood of release).

In the unlikely event an earthquake induced liner failure does occur, this study predicts the largest releases would come from high-density loading cases without 10 CFR 50.54(hh)(2) mitigation measures. However, for each high-density loading release case, the corresponding low-density loading case also resulted in a release. The low-density cases generally resulted in a smaller release due to the smaller inventory of radioactive materials and the lower potential for hydrogen combustion. For the high-density cases, the releases are limited to a few percent of the cesium inventory, except for a few cases that predicted hydrogen combustion and resulted in releases of one to two orders of magnitude higher than the other cases. In these cases, the spent fuel heats up in a steam environment leading to oxidation of zirconium and releasing hydrogen gas into the reactor building. The mixing and reaction of hydrogen and oxygen leads to a hydrogen combustion and substantially damages the reactor building. That damage could breach structures that would retain radioactive material, along with allowing more oxygen into the building, potentially increasing the severity of the spent fuel fire. The study included a sensitivity analysis for a 1x8 loading pattern (hotter fuel surrounded by 8 cooler assemblies in a repeating pattern) which also resulted in smaller radioactive releases because the hotter assembly transfers its heat to the cooler assemblies resulting in lower peak fuel temperatures

Following the evaluation of successful and unsuccessful mitigation cases, a limited-scope human reliability analysis was performed to estimate the likelihood of successful operator actions implementing 10 CFR 50.54(hh)(2) mitigation measures to prevent fuel damage. Assumptions included post-earthquake on-site portable mitigation equipment required by 10 CFR 50.54(hh)(2) is available, minimum plant staffing are available for implementing spent fuel pool mitigation, and the work area is accessible to perform mitigation. The structural and accident progression analyses show that at least 99% of the time, the earthquake would not result in spent fuel overheating even without mitigative actions for the first seven days following the accident. For the remaining times, mitigative actions are needed to prevent fuel damage and the calculated mitigation success rates range from about 25% to 95% depending on plant conditions and assuming that the refueling floor is accessible. There are two exceptions where mitigation will be ineffective under the moderate leak scenarios: (1) if the earthquake occurs at the beginning of a refueling outage when the spent fuel is too hot for the assumed mitigation, and (2) if the earthquake occurs when spent fuel is relatively hot and the reactor and spent fuel pool are hydraulically disconnected resulting in insufficient time to deploy mitigation and natural cooling mechanisms cannot prevent fuel damage.

The study's analyses shows that a release from a spent fuel pool accident after the severe earthquake at the reference plant could occur about one time in 10 million years or lower. The factors leading to this low likelihood, as discussed above, are summarized in Figure ES-2.



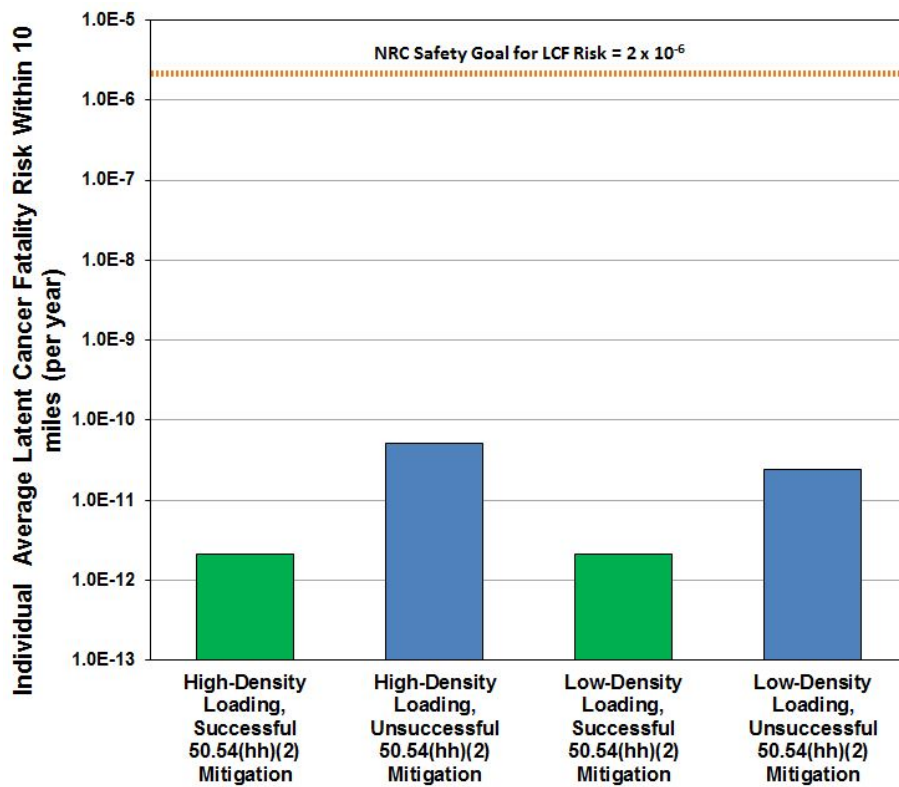
**Figure ES-2: Factors Affecting Likelihood of SFP Release from a Severe Seismic Event**

The study then estimated consequences to the public of a low likelihood spent fuel pool accident release. The releases of radioactive material are generally comparable to past studies. Despite the fairly large releases for certain predicted accident progressions, consequence analysis of all scenarios indicated zero early fatalities from acute radiation effects because protective actions were modeled to be effective in limiting doses to the public. The study also showed that the risk of an individual dying from cancer from the radioactive release is very low. When including the very low likelihood of a release, the risk in the analyzed scenarios that an average individual within 10 miles receives a fatal latent cancer is between about two in a trillion and five in a hundred billion per year. The risks are similar between different loading or mitigation scenarios because of modeled offsite protective actions that include evacuation, sheltering, relocation, and decontamination. Additionally, these individual risks are dominated by long-term exposures to very lightly contaminated areas for which doses are small enough for the areas to be considered habitable.

In order to do a regulatory analysis to inform whether low density loading should be required at the reference plant, cost estimates of potential protective measures are considered along with other parameters in a cost-benefit analysis. The study shows that, while public health effects from these low likelihood spent fuel pool releases are expected to be very low for all the scenarios studied, offsite protective measures in the form of population relocation and land interdiction may be extensive. High-density loading releases without 10 CFR 50.54(hh)(2) mitigation measures are calculated to result in release frequency-weighted land interdiction

values of 0.001 mi<sup>2</sup> per year and 0.5 displaced individuals per year which are arrived at by multiplying the estimated frequency and the estimated consequence. While the amount of land interdiction can be large, the fraction expected to be permanently interdicted is small if a release were to occur. For low-density loading or with successful deployment of 10 CFR 50.54(hh)(2) mitigation measures, considerably less land interdiction and displaced individuals are predicted.

Comparisons of the calculated individual latent cancer fatality (LCF) risk within 10 miles to the NRC Safety Goal are provided in Figure ES-3 to give context that may help the reader to understand the contribution to cancer risks from the accident scenarios that were studied. The NRC Safety Goal for latent cancer fatality risk from nuclear power plant operation (i.e.,  $2 \times 10^{-6}$  or two in one million per year) is set 1,000 times lower than the sum of cancer fatality risks resulting from all other causes (i.e.,  $\sim 2 \times 10^{-3}$  or two in one thousand per year).



**Figure ES-3: Comparison of Population-Weighted Average Individual Latent Cancer Fatality Risk Results for this Study to the NRC Safety Goal (plotted on logarithmic scale)**

Comparing the study results to the NRC Safety Goal does involve important limitations. First, the safety goal is intended to encompass all accident scenarios on a nuclear power plant site, including both reactors and spent fuel. This study does not examine all scenarios that would need to be considered in a probabilistic risk assessment for a spent fuel pool, although seismic contributors are considered the most important contributors to spent fuel pool risk. Also, this study represents a mix of limited probabilistic considerations with a deterministic treatment of mitigating features. All analytical techniques, both deterministic and probabilistic, have inherent limitations of scope and method and also have uncertainty of varying degrees and types. As a result, comparison of the scenario-specific calculated individual LCF risk to the NRC Safety

Goal is incomplete. However, it is intended to show how multiple spent fuel pool scenarios' risk results in the one in a trillion ( $10^{-12}$ ) to one in 10 billion ( $10^{-10}$ ) per year LCF range) are low. While the results of this study are scenario-specific and related to a single spent fuel pool, staff concludes that since these risks are several orders of magnitude smaller than the  $2 \times 10^{-6}$  (two in one million) individual LCF risk that corresponds to the safety goal for latent cancer fatalities, it is unlikely that the results here would contribute significantly to a risk that would challenge the Commission's safety goal policy (NRC, 1986).

In conclusion, past SFP risk studies have shown that high-density spent fuel storage is safe and risk of a release due to an accident is low. This study is consistent with earlier research conclusions that spent fuel pools are robust structures that are likely to withstand severe earthquakes without leaking. This study estimated that the likelihood of a radiological release from the spent fuel pool resulting from the selected severe seismic event analyzed in this study is on the order of one time in 10 million years or lower. For the hypothetical releases studied, no early fatalities attributable to radiation exposure were predicted and individual latent cancer fatality risks are projected to be low, but extensive protective actions may be needed.

The study results demonstrated that in a high-density loading configuration, dispersing hotter fuel throughout the pool or successful mitigation generally prevented or reduced the size of potential releases. Low-density loading reduced the size of potential releases but did not affect the likelihood of a release. When a release is predicted to occur, early and latent fatality risks for individual members of the public do not vary significantly between the scenarios studied because protective actions, including relocation of the public and land interdiction, were modeled to be effective in limiting exposure. The beneficial effects in the reduction of offsite consequences between a high-density loading scenario and a low-density loading scenario are primarily associated with the reduction in the potential extent of land contamination and associated protective actions. The regulatory analysis for this study indicates that expediting movement of spent fuel from the pool does not provide a substantial safety enhancement for the reference plant. The NRC plans to use the insights from this analysis to help inform a broader regulatory analysis of the spent fuel pools at U.S. nuclear reactors as part of its Japan Lessons-learned Tier 3 plan. The NRC continues to believe, based on this study and previous studies that high density storage of spent fuel in pools protects public health and safety.

# CONTENTS

<u>Section</u>	<u>Page</u>
LIST OF FIGURES .....	xx
LIST OF TABLES.....	xxiv
ABBREVIATIONS AND ACRONYMS .....	xxviii
1. INTRODUCTION AND BACKGROUND.....	1
1.1 Project Impetus.....	3
1.2 Technical Approach .....	4
1.3 Site Specificity and Familiarization .....	5
1.4 Basic Scenario Development .....	6
1.5 Rationale for Focusing on Consequences of a Seismic Hazard .....	6
1.6 Operating Cycle Phase Approach .....	9
1.7 Overview of Past Studies.....	10
1.8 Potential Follow-On Work and Related Activities .....	17
1.9 Layout of Remainder of This Report .....	18
2. MAJOR ASSUMPTIONS .....	19
2.1 Study Assumptions .....	19
2.2 Multi-Unit Considerations.....	28
2.3 Inadvertent Criticality .....	29
3. SEISMIC HAZARD CHARACTERIZATION.....	31
3.1 Basis for Probabilistic Estimates .....	31
3.2 Characterization of the Event Likelihood.....	34
3.3 Characterization of the Ground Motion Response Spectra.....	36
4. STRUCTURAL ANALYSIS AND RELATED INITIAL DAMAGE CHARACTERIZATION.....	39
4.1 Damage States for the Spent Fuel Pool Structure.....	39
4.1.1 Approach and Seismic Loads .....	39
4.1.2 Description of the Spent Fuel Pool Structure .....	47
4.1.3 Finite Element Model Description.....	51
4.1.4 Finite Element Analysis Results for the Spent Fuel Pool.....	56
4.1.5 Damage States .....	61
4.2 Other Damage States .....	66
4.3 Review of Spent Fuel Pool Performance under Recent Major Earthquakes in Japan..	68
5. SCENARIO DELINEATION AND PROBABILISTIC CONSIDERATIONS.....	76
5.1 Representative Operating Cycle Characterization.....	76
5.2 Operating Cycle Phase Specification .....	77
5.3 Treatment of Mitigation .....	79

5.3.1	Approach Details and Assumptions .....	82
5.3.2	Rationale for Producing Unmitigated Results .....	85
5.4	Refueling Floor Dose Rate Analysis Using SCALE .....	86
5.5	Discussion of Repair and Recovery .....	89
5.6	Scenario Development.....	89
5.6.1	Identification of Key Events.....	89
5.6.2	Scenario Calculation Matrices.....	90
5.6.3	Summary of Event Split Fractions .....	90
6.	ACCIDENT PROGRESSION ANALYSIS .....	92
6.1	Modeling Spent Fuel Pools with MELCOR .....	92
6.1.1	Overview and Experimental/Analytical Basis.....	92
6.1.2	Heat Transfer Modeling within Spent Fuel Pool and to Surrounding Walls.....	95
6.1.3	Modeling of Mitigative Sprays .....	96
6.1.4	Modeling of Fuel Collapse and Baseplate Failure .....	97
6.1.5	Radionuclide Transport Modeling and Treatment of Hydrogen .....	98
6.2	Description of MELCOR Models .....	103
6.2.1	High-Density Loading during Outage .....	108
6.2.2	High-Density Loading Postoutage.....	112
6.2.3	Low-Density Loading during Outage .....	112
6.2.4	Low-Density Loading Postoutage.....	114
6.3	MELCOR Analysis Results .....	115
6.3.1	Sequences That Do Not Lead to a Release .....	115
6.3.2	Sequences That Do Lead to a Release.....	126
6.3.3	Source Terms for Offsite Consequence Analysis .....	146
6.3.4	Accumulation of Water Elsewhere in the Reactor Building.....	147
7.	OFFSITE CONSEQUENCE ANALYSIS.....	150
7.1	Offsite Consequence Modeling .....	150
7.1.1	Radiological Source Term.....	150
7.1.2	Atmospheric Modeling and Meteorology .....	152
7.1.3	Exposure, Dosimetry, and Health Effects Modeling .....	153
7.1.4	Emergency Response Modeling .....	154
7.1.5	Long-Term Protective Action Modeling .....	159
7.2	Offsite Consequence Results.....	160
7.2.1	Individual Early Fatality Risk .....	163
7.2.2	Individual Latent Cancer Fatality Risk .....	163
7.2.3	Land Contamination.....	167

7.2.4	Displaced Individuals .....	169
7.3	Offsite Consequence Comparison .....	170
8.	HUMAN RELIABILITY ANALYSIS .....	173
8.1	Summary of Spent Fuel Pool Study Analysis Results Relevant to Human Reliability Analysis .....	175
8.1.1	High Level Scenarios Classification .....	175
8.1.2	Key Factors Affecting Available Time for Mitigation .....	176
8.2	Staffing, Mitigation Equipment, Strategies, and Procedures .....	180
8.2.1	Staffing, Procedures, Training, and Response Time .....	180
8.2.2	Mitigation Equipment .....	182
8.2.3	Mitigation Strategies .....	183
8.3	Study Framework, Scope, and Approach .....	187
8.3.1	Study Framework and Scope .....	187
8.3.2	Approach to Human Error Probability Estimates .....	188
8.3.2.1	A Two-Phased Approach to HEP Estimates .....	188
8.3.2.2	Step 1—Identify the Time Required .....	188
8.3.2.3	Step 2—Identify the Damage States and Available Time .....	190
8.3.2.4	Step 3—Estimate Basic HEPs of a Single Unit Event .....	190
8.3.2.5	Step 4—Additional Feasibility Considerations .....	194
8.4	Discussion and Summary .....	196
9.	CONSIDERATION OF UNCERTAINTY .....	198
9.1	Sensitivity to Hydrogen Combustion (MELCOR) .....	198
9.2	Sensitivity to 1x8 Fuel Assembly Pattern (MELCOR) .....	203
9.3	Sensitivity to a Contiguous (Uniform) Fuel Pattern during an Outage (MELCOR/MACCS2) .....	208
9.4	Sensitivity to Multiunit or Concurrent Accident Events (MELCOR) .....	218
9.5	Sensitivity to Molten Core-Concrete Interaction (MELCOR/MACCS2) .....	222
9.6	Sensitivity to Radiative Heat Transfer (MELCOR) .....	225
9.7	Sensitivity to Land Contamination (MACCS2) .....	225
9.8	Sensitivity to Time Truncation (MELCOR/MACCS2) .....	227
9.9	Sensitivity to Reactor Building Leakage (MELCOR) .....	229
10.	ASSESSMENT OF PREVIOUS STUDIES OF SAFETY CONSEQUENCES ASSOCIATED WITH LOADING, TRANSFER, AND LONG-TERM DRY STORAGE .....	230
10.1	Introduction .....	230
10.2	Previous Spent Fuel Pool Studies .....	230
10.2.1	Quantitative Comparison of Spent Fuel Pool Analytical Results .....	231
10.2.2	Comparison of SFPS Results to previous Spent Fuel Pool Studies .....	233

10.3	Previous Dry Cask Storage Studies .....	234
10.3.1	Supplemental Analyses .....	234
10.3.2	Quantitative Comparison of Dry Cask Storage and SFPS Analytical Results .....	239
10.3.3	Comparison of SFPS Results to Previous and Supplemental Cask Studies.....	239
10.4	Summary of Assessment of Previous Studies.....	240
11.	REGULATORY ANALYSIS SCREENING SUMMARY .....	241
11.1	Decision Rationale .....	241
11.1.1	Comparison to the Safety Goal Policy Statement.....	241
11.1.2	Cost-Benefit Analysis.....	242
11.2	Further Actions .....	243
12.	SUMMARY AND CONCLUSIONS.....	245
12.1	Summary .....	245
12.2	Conclusions .....	249
13.	REFERENCES.....	252
	APPENDIX A: DETAILED EMERGENCY RESPONSE MODELS.....	A-1
	A.1 Evacuation Model 1: WinMACCS response parameters for sequences where PAGs are not exceeded beyond the EPZ. ....	A-1
	A.2 Evacuation Model 2: WinMACCS response parameters for late release sequences where the PAG is exceeded beyond the EPZ.....	A-3
	A.3 Evacuation Model 3: WinMACCS response parameters for early release sequences where the PAG is exceeded beyond the EPZ. ....	A-6
	APPENDIX B: A QUALITATIVE RISK COMPARISON OF SPENT FUEL STORAGE STRATEGIES .....	B-1
	B.1 Introduction .....	B-1
	B.2 Spent Fuel Storage Strategies .....	B-1
	B.3 Spent Fuel Storage Stages .....	B-1
	B.4 Risk of Spent Fuel Storage .....	B-2
	B.5 Risk during Each Stage.....	B-3
	B.6 Total Risk over Time .....	B-5
	B.7 Availability of Information .....	B-6
	B.7.1 Cask Risks ( $r_{\text{cask,load}}$ and $r_{\text{cask,store}}$ ) .....	B-7
	B.7.2 Number of Casks ( $N_{\text{load}}$ and $N_{\text{store}}$ ) .....	B-7
	B.7.3 Pool Uncovery Frequency from Cask Drop Events ( $N_{\text{load}}$ , $P_{\text{drop}}$ and $P_{\text{damage}}$ ) .....	B-8
	B.7.4 Pool Uncovery Frequency from Seismic Events ( $F_{\text{seismic}}$ ).....	B-9
	B.7.5 Pool Uncovery Frequency from Other Events ( $F_{\text{other}}$ ) .....	B-10
	B.7.6 Pool Consequences ( $C_{\text{uncovery}}$ ).....	B-10
	B.7.7 Other Spent Fuel Risk Considerations .....	B-11
	B.8 Conclusions .....	B-11



APPENDIX C: COMMISSION AND ACRS CORRESPONDENCE .....	C-1
APPENDIX D: REGULATORY ANALYSIS AND BACKFITTING DISCUSSION TO DETERMINE THE SAFETY BENEFIT OF EXPEDITED TRANSFER OF SPENT FUEL AT A REFERENCE PLANT .....	D-1
D.1 INTRODUCTION .....	D-3
D.1.1 Statement of the Problem .....	D-3
D.1.2 Objective of Proposed Action.....	D-4
D.2 IDENTIFICATION AND PRELIMINARY ANALYSIS OF ALTERNATIVE APPROACHES	D-5
D.2.1 Alternative 1 – Regulatory Baseline – Maintain the Existing Spent Fuel Storage Requirements .....	D-5
D.2.2 Alternative 2 – Low-density Spent Fuel Pool Storage .....	D-6
D.3 ESTIMATION AND EVALUATION OF VALUES AND IMPACTS .....	D-6
D.3.1 Identification of Affected Attributes .....	D-7
D.3.2 Methodology Overview .....	D-8
D.3.2.1 Analysis Model .....	D-9
D.3.2.1.1 Baseline for the Analysis.....	D-9
D.3.2.1.2 Discount Rates .....	D-10
D.3.2.2 Data .....	D-10
D.3.2.2.1 Spent Fuel Pool Initiator Release Frequency .....	D-10
D.3.2.2.2 Duration of On-site Spent Fuel Storage Risk .....	D-15
D.3.2.2.3 Cost/Benefit Inflaters.....	D-15
D.3.2.2.4 Dollar per Person-Rem Conversion Factor .....	D-16
D.3.2.2.5 Onsite Property Decontamination, Repair, and Refurbishment Costs .....	D-16
D.3.2.2.6 Replacement Energy Costs .....	D-17
D.3.2.2.7 Occupational Worker Exposure (Accident).....	D-17
D.3.2.2.8 Long-Term Habitability Criteria .....	D-21
D.3.2.2.9 Other Key Data .....	D-23
D.3.2.3 Assumptions.....	D-23
D.3.2.3.1 Projected Number of Outages and Spent Fuel Assemblies.....	D-23
D.3.2.3.2 Dry Storage Capacity.....	D-24
D.3.2.3.3 Fuel Assembly Decay Heat as a Function of Burnup and Cooling Time....	D-25
D.3.2.3.4 Dry Storage Upfront Costs .....	D-25
D.3.2.3.5 Incremental Costs Associated with Earlier DSC Purchase and Loading....	D-26
D.3.2.3.6 Incremental Annual ISFSI Operating Costs.....	D-26
D.3.2.3.7 Dry Storage Occupational Exposure (Routine).....	D-27
D.3.2.3.8 Number of Dry Storage Casks .....	D-28
D.3.3 Sensitivity Analysis .....	D-29

D.3.3.1	Present Value Calculations .....	D-29
D.3.3.2	Dollar per Person-Rem Conversion Factor .....	D-29
D.3.3.3	Replacement Energy Costs .....	D-30
D.3.3.4	Consequences Extending Beyond 50 Miles .....	D-30
D.3.4	Alternative – Low-Density Spent Fuel Pool Storage .....	D-31
D.3.4.1	Public Health (Accident) .....	D-31
D.3.4.2	Occupational Health (Accident) .....	D-32
D.3.4.3	Occupational Health (Routine) .....	D-33
D.3.4.4	Offsite Property .....	D-34
D.3.4.5	Onsite Property .....	D-35
D.3.4.6	Industry Implementation .....	D-35
D.3.4.7	Industry Operation .....	D-36
D.3.4.8	NRC Implementation .....	D-37
D.3.4.9	NRC Operation .....	D-37
D.3.4.10	Other Considerations .....	D-37
D.3.4.10.1	Modeling Uncertainties .....	D-37
D.3.4.10.2	Cask Handling Risk .....	D-37
D.3.4.10.3	Mitigating Strategies .....	D-38
D.3.4.10.4	Other Favorable Spent Fuel Loading Configurations .....	D-39
D.4	PRESENTATION OF RESULTS .....	D-39
D.4.1	Regulatory Analysis .....	D-39
D.4.1.1	Summary Table .....	D-39
D.4.1.2	Implementation and Operation Costs .....	D-41
D.4.1.3	Total Benefits and Cost Offsets .....	D-41
D.4.1.4	Sensitivity Analysis .....	D-41
D.4.1.4.1	Dollar per Person-Rem Conversion Factor .....	D-42
D.4.1.4.2	Consequences Extending Beyond 50 Miles .....	D-42
D.4.1.4.3	Combined Effect of Consequences Extending Beyond 50 Miles and Dollar per Person-Rem Conversion Factor .....	D-43
D.4.2	Backfit Analysis .....	D-44
D.4.2.1	General Description of the Activity Required at the Reference Plant to Complete the Backfit .....	D-45
D.4.2.2	Potential Change in the Risk to the Public from the Accidental Offsite Release of Radioactive Material .....	D-45
D.4.2.3	Potential Impact on Radiological Exposure of Facility Employees .....	D-45
D.4.2.4	Installation and Continuing Costs Associated with the Backfit, including the Cost of Facility Downtime or the Cost of Construction Delay .....	D-46

D.4.2.5	Potential Safety Impact of Changes in Plant or Operational Complexity, including the Relationship to Proposed and Existing Regulatory Requirements .....	D-46
D.4.2.6	Estimated Resource Burden on the NRC Associated with the Proposed Backfit and the Availability of Such Resources. ....	D-46
D.4.2.7	Potential Impact of Differences in Facility Type, Design, or Age on the Relevancy and Practicality of the Proposed Action .....	D-47
D.4.2.8	Whether the Proposed Backfit is Interim or Final and, if Interim, the Justification for Imposing the Proposed Backfit on an Interim Basis .....	D-47
D.4.2.9	Other Information Relevant and Material to the Proposed Backfit.....	D-47
D.4.3	Disaggregation .....	D-48
D.4.4	Safety Goal Evaluation .....	D-49
D.4.5	CRGR Results.....	D-50
D.5	DECISION RATIONALE .....	D-50
D.5.1	Regulatory Analysis.....	D-50
D.5.2	Backfit Analysis .....	D-50
D.5.3	Conclusion.....	D-51
D.6	REFERENCES .....	D-52
APPENDIX E:	SFPS PUBLIC COMMENTS SUMMARY .....	E-55

## LIST OF FIGURES

<u>Figure</u>	<u>Page</u>
Figure 1 Graphical overview of significant SFP-related activities.....	10
Figure 2 Comparison of PGA exceedance frequencies at the reference plant.....	32
Figure 3 Comparison of spectral exceedance frequencies at the reference plant (rock hazard curves).....	32
Figure 4 Comparison of annual PGA exceedance frequencies for U.S. Mark I reactors (USGS 2008 model) (rock hazard curves).....	33
Figure 5 Comparison of annual exceedance frequencies for 1 Hz spectral accelerations for U.S. Mark I reactors (USGS 2008 model) (rock hazard curves) .....	33
Figure 6 Comparison of seismic initiating event frequencies .....	34
Figure 7 Input acceleration response spectrum and SSE (Horizontal Ground Motion) .....	36
Figure 8 Response spectrum for 5-percent damping scaled to 1.0 g PGA: SSE, NUREG/CR-4550 (NUREG-1150 PRA), and this study (GI-199) .....	37
Figure 9 Horizontal response spectrum (5-percent damping): SSE, SFP Study and NUREG-1150 PRA (for 0.71g PGA).....	38
Figure 10 Vertical ISRS for 5-percent damping at Elevation 195 ft (bottom of the SFP) .....	45
Figure 11 Horizontal ISRS for 5-percent damping midway between Elevation 195 ft and Elevation 234 ft (midheight of the SFP).....	45
Figure 12 Vertical ISRS for 5-percent and 10-percent damping at Elevation 195 ft (bottom of the SFP) .....	46
Figure 13 Horizontal ISRS for 5-percent and 10-percent damping midway between Elevation 195 ft and Elevation 234 ft (midheight of the SFP) .....	46
Figure 14 Schematic diagram of the reactor building foundation near the drywell .....	47
Figure 15 SFP details in cutout of 3D CAD model.....	48
Figure 16 Cutouts of 3D CAD models of the reactor building and SFP.....	49
Figure 17 Finite element model of the SFP structure with labels for the floor and walls.....	49
Figure 18 Outline of detailed finite element model of the SFP liner representing attachments to the SFP floor and walls (E and W walls).....	50
Figure 19 Cutouts of 3D finite element model showing components included in the model .....	51
Figure 20 Estimated peak vertical accelerations (in/sec <sup>2</sup> ) of the SFP floor from response spectrum analysis and vertical ISRS as input (1.0g PGA and 5-percent damping).....	56
Figure 21 Estimated peak hydrodynamic pressures (psi) on the SFP floor from response spectrum analysis and vertical ISRS as input (1.0g PGA and 5-percent damping).....	56
Figure 22 Contours of vertical displacements (mm) of the SFP floor and walls .....	57
Figure 23 Contours of vertical displacement (mm) of the SFP walls.....	58
Figure 24 Liner strains (overall response not fully accounting for strain concentrations) .....	58
Figure 25 Region of concrete cracking initiation at the floor-wall junction.....	59
Figure 26 SFP displacements (mm) with detailed liner insert .....	60
Figure 27 Strain concentrations in the SFP liner .....	60
Figure 28 Moderate leakage flow rate (through concrete cracks) .....	64
Figure 29 Small leakage flow rate (through localized steel tears).....	66
Figure 30 Vertical response spectra: Kashiwazaki-Kariwa Units 1 and 4 (foundation level) and SFP study (free-field) .....	72
Figure 31 Horizontal response spectra: Fukushima Daiichi Units 1 and 4 (foundation) and SFP study (free-field).....	73
Figure 32 Vertical response spectra: Fukushima Daiichi Unit 4 (foundation) and SFP study (free-field) .....	73
Figure 33 Vertical ISRS for Kashiwazaki-Kariwa Units 1 and 4 and for the SFP Study.....	74

Figure 34	Illustration of SFP patterns .....	77
Figure 35	Cutaway depiction of a lifted assembly with water level at the top of the racks.....	86
Figure 36	Approximate dose rate of elevation contours, water at top of fuel hardware, around the time of defueling (rem per hour) .....	88
Figure 37	MELCOR modeling of heat transfer paths .....	96
Figure 38	Spray model for SFP analysis .....	97
Figure 39	Typical SFP rack cut away cross sections.....	104
Figure 40	MELCOR nodalization of the whole pool high density model.....	105
Figure 41	MELCOR nodalization of the assemblies (only two rings shown) .....	106
Figure 42	MELCOR reactor building model.....	108
Figure 43	SFP and reactor connection model during outage.....	109
Figure 44	Layout of assemblies for OCP1 high density (1x4) model .....	110
Figure 45	MELCOR radial radiative coupling scheme .....	111
Figure 46	Layout of assemblies for OCP2 high-density (1x4) model .....	111
Figure 47	Layout of assemblies for OCP1 low-density model.....	113
Figure 48	Layout of assemblies for OCP2 low-density model.....	114
Figure 49	Water level for boiloff scenarios .....	116
Figure 50	Water level for mitigated low-density OCP1 (small leak) scenario .....	117
Figure 51	Flow rates for mitigated low-density OCP1 (small leak) scenario .....	118
Figure 52	Water level for unmitigated high-density moderate leak (OCP4) .....	119
Figure 53	Ring 1 temperature for unmitigated high-density moderate leak (OCP4).....	119
Figure 54	Water level for unmitigated high-density small leak (OCP4) .....	120
Figure 55	Ring 1 temperature for unmitigated high-density small leak (OCP4) .....	120
Figure 56	Ring 1 temperature for unmitigated low-density moderate leak (OCP4) .....	121
Figure 57	Ring 1 temperature for unmitigated low-density small leak (OCP4).....	121
Figure 58	Water level for mitigated high-density moderate leak (OCP3) .....	123
Figure 59	Water flow rates for mitigated high-density moderate leak (OCP3) .....	123
Figure 60	Ring 1 clad temperatures for mitigated (simple flow regime active) high-density moderate leak (OCP3) .....	124
Figure 61	Ring 1 clad temperatures for mitigated (simple flow regime inactive) high-density moderate leak (OCP3) .....	124
Figure 62	Flow rates for mitigated high-density moderate leak (OCP3) with late actuation of sprays .....	125
Figure 63	Ring 1 clad temperatures for mitigated (simple flow regime active) high-density moderate leak (OCP3) with late actuation of sprays.....	125
Figure 64	Ring 1 clad temperatures for mitigated (simple flow regime inactive) high-density moderate leak (OCP3) with late actuation of sprays.....	126
Figure 65	Water level for unmitigated high-density moderate leak (OCP1) .....	128
Figure 66	SFP power for unmitigated high-density moderate leak (OCP1).....	129
Figure 67	Ring 1 clad temperature for unmitigated high-density moderate leak (OCP1) .....	129
Figure 68	Midplane clad temperature for unmitigated high-density moderate leak (OCP1) ....	130
Figure 69	Midplane rack temperature for unmitigated high-density moderate leak (OCP1) ....	130
Figure 70	SFP wall liner temperature for unmitigated high-density moderate leak (OCP1) ....	131
Figure 71	Reactor building DF for unmitigated high-density moderate leak (OCP1).....	131
Figure 72	Cesium environmental release fraction for unmitigated high-density moderate leak (OCP1) .....	132
Figure 73	Ring 1 clad temperature for unmitigated low-density moderate leak (OCP1).....	132
Figure 74	Midplane clad temperature for unmitigated low-density moderate leak (OCP1).....	133
Figure 75	Cesium environmental release fraction for unmitigated low-density moderate leak (OCP1) .....	133
Figure 76	Water level for mitigated high-density moderate leak (OCP1) .....	135

Figure 77 Ring 1 clad temperature for mitigated high density moderate leak (OCP1).....	135
Figure 78 Cesium environmental release fraction for mitigated high density moderate leak (OCP1) .....	136
Figure 79 Ring 1 clad temperature for mitigated low density moderate leak (OCP1).....	136
Figure 80 Cesium environmental release fraction for mitigated low density moderate leak (OCP1) .....	137
Figure 81 Water level for unmitigated high-density small leak (OCP2) .....	138
Figure 82 SFP power for unmitigated high-density small leak (OCP2) .....	138
Figure 83 Ring 1 clad temperature for unmitigated high-density small leak (OCP2) .....	139
Figure 84 Midplane clad temperature for unmitigated high-density small leak (OCP2) .....	139
Figure 85 Reactor building mole fraction for unmitigated high-density small leak (OCP2) .....	140
Figure 86 Reactor building DF for unmitigated high-density small leak (OCP2).....	140
Figure 87 Cesium environmental release fraction for unmitigated high-density small leak (OCP2) .....	141
Figure 88 Ring 1 clad temperature for unmitigated low-density small leak (OCP2) .....	141
Figure 89 Midplane clad temperature for unmitigated low-density small leak (OCP2) .....	142
Figure 90 Ring 1 clad temperature for unmitigated high-density moderate leak (OCP3) .....	143
Figure 91 SFP wall liner temperature for unmitigated high-density moderate leak (OCP3) ....	144
Figure 92 Reactor building mole fractions for unmitigated high-density moderate leak (OCP3) .....	144
Figure 93 Ring 1 clad temperature for unmitigated low-density moderate leak (OCP3).....	145
Figure 94 MELCOR default ruthenium release for unmitigated high-density moderate leak (OCP3) .....	145
Figure 95 MELCOR enhanced ruthenium release under air oxidizing conditions for unmitigated high density moderate leak (OCP3) .....	146
Figure 96 Individual Latent Cancer Fatality Risk (per year) .....	166
Figure 97 Conditional Individual LCF Risk for Different Dose Truncations and Distances .....	167
Figure 98 Approximate dose rate of elevation contours, water at the top of fuel hardware, around the time of defueling (rem per hour). .....	178
Figure 99 The refueling floor temperature of OCP1 small leak scenarios. ....	179
Figure 100 The refueling floor temperature of OCP 2 small leak scenarios. ....	179
Figure 101 Generalized guidance for SFP makeup and spray decisions.....	187
Figure 102 The study framework.....	188
Figure 103 Flow chart for estimating HEPs for a single reactor unit event.....	192
Figure 104 The gap release probability assessments given damage to multiple reactors and SFPs.....	195
Figure 105 Reactor building mole fraction for unmitigated high-density moderate leak (OCP2) .....	199
Figure 106 Reactor building mole fraction for unmitigated high-density moderate leak (OCP2-S) .....	199
Figure 107 SFP power for unmitigated high-density moderate leak (OCP2).....	200
Figure 108 SFP power for unmitigated high-density moderate leak (OCP2-S) .....	200
Figure 109 Ring 1 clad temperature for unmitigated high-density moderate leak (OCP2) .....	201
Figure 110 Ring 1 clad temperature for unmitigated high-density moderate leak (OCP2-S) ...	201
Figure 111 Cesium environmental release fraction for unmitigated high density moderate leak (OCP2) .....	202
Figure 112 Cesium environmental release fraction for unmitigated high density moderate leak (OCP2-S) .....	202
Figure 113 Layout of assemblies for OCP3 high density (1x8) model .....	203
Figure 114 Ring 1 clad temperature for unmitigated high-density small leak (OCP3; 1x8) .....	204
Figure 115 Midplane clad temperature for unmitigated high-density small leak (OCP3; 1x8) .	205

Figure 116 Ring 1 clad temperature for unmitigated high-density small leak (OCP3; 1x4) .....	205
Figure 117 Midplane clad temperature for unmitigated high-density small leak (OCP3; 1x4) .....	206
Figure 118 Ring 1 clad temperature for unmitigated high-density small leak (OCP2; 1x8) .....	206
Figure 119 Ring 1 clad temperature for unmitigated high-density small leak (OCP2; 1x4) .....	207
Figure 120 Environmental release fractions for unmitigated high-density small leak (OCP2; 1x8) .....	207
Figure 121 Environmental release fractions for unmitigated high-density small leak (OCP2; 1x4) .....	208
Figure 122 Layout of assemblies for OCP1 high-density (uniform) model .....	209
Figure 123 Layout of assemblies for OCP2 high-density (uniform) model .....	209
Figure 124 Ring 1 clad temperature for unmitigated uniform high-density moderate leak (OCP1) .....	210
Figure 125 Cesium environmental release fraction for unmitigated uniform high-density moderate leak (OCP1) .....	211
Figure 126 Ring 1 clad temperature for mitigated uniform high-density moderate leak (OCP2) with 500 gpm injection.....	212
Figure 127 Ring 1 clad temperature for mitigated uniform high-density moderate leak (OCP2) with 200 gpm spray.....	212
Figure 128 Ring 1 clad temperature for mitigated uniform high density moderate leak (OCP2) with 500 gpm spray.....	213
Figure 129 Ring 1 clad temperature for unmitigated high-density moderate leak (OCP3) .....	219
Figure 130 Ring 1 clad temperature for unmitigated high-density moderate leak (OCP3; early reactor building failure).....	220
Figure 131 Ring 1 clad temperature for unmitigated high-density moderate leak (OCP3; late reactor building failure).....	220
Figure 132 Ring 1 clad temperature for unmitigated high-density moderate leak (OCP4) .....	221
Figure 133 Ring 1 clad temperature for unmitigated high-density moderate leak (OCP4; late reactor building failure).....	221
Figure 134 SFP concrete floor temperature for unmitigated high-density moderate leak (OCP3; late reactor building failure).....	223
Figure 135 Cesium release fraction for unmitigated high-density moderate leak (OCP3; late reactor building failure) with and without MCCI .....	223
Figure 136 Land Contamination Sensitivity to Dose Criteria.....	227
Figure 137 Atmospheric release fractions for unmitigated high density small leak (OCP3) with a 96 hour time truncation .....	228
Figure 138: Affecting Likelihood of SFP Release from a Severe Seismic Event.....	249
Figure 139: Comparison of Population-Weighted Average Individual Latent Cancer Fatality Risk Results for this Study to the NRC Safety Goal (plotted on logarithmic scale) .....	250
Figure 140 The Reference Plant's Wind Rose.....	A-3
Figure 141 Graphical representation of spent fuel risks.....	B-4
Figure 142: Dose Rate in Vicinity of Fukushima Daiichi Nuclear Plant Site Main Gate between March 11 and March 16, 2011 .....	D-18
Figure 143: Fukushima Daiichi Site Dose Rates between March 22 and March 23, 2011 ....	D-19

## LIST OF TABLES

<u>Table</u>	<u>Page</u>
Table 1 Frequency of SFP Fuel Uncovery (/yr) .....	9
Table 2 Comparison of Fuel Age and Heat Load against Industry Averages .....	17
Table 3 Major Assumptions .....	19
Table 4 Seismic Bins and Initiating Event Frequencies .....	34
Table 5 Comparison of Seismic Frequencies from Various Sources .....	35
Table 6 Estimated Natural Frequencies of Vibration for the Peach Bottom Reactor Building (Lambright et al., 1990) .....	44
Table 7 Material Properties for the Nonlinear Finite Element Analyses .....	53
Table 8 Approximate Dead Loads on the SFP Floor in Terms of an Equivalent Vertical Floor Pressure .....	54
Table 9 Approximate Peak Equivalent Seismic Loads in Terms of an Equivalent Static Vertical Floor Pressure .....	54
Table 10 Fukushima Daiichi, Measured and Design (DBGM $S_S$ ) PGAs at Foundation Slab .....	70
Table 11 Onagawa, Measured and Design (DBGM $S_S$ ) PGAs at Foundation Slab (Tohoku, 2011 Earthquake) .....	70
Table 12 Fukushima Daiichi, Measured and Design (DBGM $S_S$ ) PGAs at Foundation Slab (Tohoku, 2011 Earthquake).....	70
Table 13 Tokai, Measured and Design (DBGM $S_S$ ) PGAs at Foundation Slab (Tohoku, 2011 Earthquake) .....	71
Table 14 Kashiwazaki-Kariwa, Measured and Design PGAs at Foundation Slab (Chuetsu-Oki, 2007 Earthquake) .....	71
Table 15 Remaining Boundary and Initial Conditions .....	76
Table 16 OCP Definition for the Modeled Operating Cycle.....	78
Table 17 Summary of Mitigation Assumptions.....	82
Table 18 Scenario Breakdown per OCP.....	90
Table 19 Refresher on the Seismic Hazard Estimates .....	90
Table 20 Refresher on ac Fragility .....	91
Table 21 Refresher on SFP Leakage Conditional Probabilities .....	91
Table 22 Refresher on the OCP Fractional Contributions.....	91
Table 23 MELCOR Radionuclide Class Composition .....	99
Table 24 Radionuclides Gap Inventories.....	100
Table 25 Distribution of Decay Heat in the Reactor and SFP for High Density Loading.....	112
Table 26 Distribution of Decay Heat in the Reactor and SFP for Low Density Loading .....	115
Table 27 Summary of Release Characteristics for High-Density Scenarios.....	148
Table 28 Summary of Release Characteristics for Low-Density Scenarios .....	149
Table 29 Release Category Types .....	151
Table 30 Release Category Tally .....	151
Table 31 Listing of Scenario-specific Release Sequences .....	152
Table 32 Summary of Evacuation Models .....	157
Table 33 Overall Consequence Results .....	162
Table 34 Dose-Response Model Results (LNT) and Dose Truncation Comparison .....	165
Table 35 Average Land Interdiction* (square miles per event) .....	168
Table 36 Average Number of Long-term Displaced Individuals* (per event).....	169
Table 37 Consequence <sup>1</sup> Comparison – High (1x4) Density / Low Density Loading without Successful 50.54(hh)(2) Mitigation .....	170
Table 38 Consequence Comparison – Unsuccessful/Successful Deployment of 50.54(hh)(2) Equipment.....	171



Table 39	The scope and assumptions of the HRA study .....	174
Table 40	The SFPS Simulation Results. ....	175
Table 41	Approximate Time of Fuel Uncovery.....	177
Table 42	The available time* .....	179
Table 43	Estimates of the Time Required for the Operator to Deploy SFP Makeup If Fire Water Is Available .....	189
Table 44	Estimates of the Time Required for the Operator to Deploy SFP Makeup .....	190
Table 45	Estimates of time required and time available for mitigation .....	190
Table 46	Time margin effects on human error probability in the SPAR-H HRA method for cognitive activities in low power /shutdown operations .....	191
Table 47	Human error probability estimates of a single unit event.....	193
Table 48	The likelihood of gap release* .....	194
Table 49	Scenario Specific Human Error Probability Estimates* .....	196
Table 50	Summary of Release Characteristics for High-Density, Uniform Pattern.....	213
Table 51	Listing of Uniform Pattern Release Sequences .....	214
Table 52	Uniform Pattern Consequence Results.....	215
Table 53	Dose Truncation Comparison for Uniform Pattern .....	216
Table 54	Consequence Comparison – High Density (1x4 and Uniform) Loading Without Successful 50.54(hh)(2) Mitigation .....	217
Table 55	Consequence Comparison – High (Uniform) Density / Low Density Loading Without Successful 50.54(hh)(2) Mitigation .....	218
Table 56	Comparison of Low-Density OCP1 Release Fractions for a Concurrent Reactor Accident.....	222
Table 57	Comparison of Release Fractions with and without MCCI. ....	224
Table 58	Consequence Comparison – Molten Core Concrete Interaction .....	224
Table 59	Low-density OCP2 Release Fraction Sensitivity to Ring-Ring Radiation .....	225
Table 60	Consequence Comparison – Land Contamination Sensitivity.....	226
Table 61	Consequence Comparison – Time Truncation Sensitivity.....	228
Table 62	Comparison of consequence results from current and previous spent fuel pool analyses.....	232
Table 63	Comparison of Source Terms from Current and Previous SFP analyses.....	233
Table 64	Modeled Inventory for Supplemental Reanalysis .....	235
Table 65	Particle Size Information.....	236
Table 66	Parameters and Results from NUREG-1864, Table E.3 .....	238
Table 67	Supplemental Reanalysis with SFPS Input Deck.....	238
Table 68	Comparison of consequence results from SFPS, NUREG-1864, and DCSS supplemental analyses.....	239
Table 69	Evacuation Model 1: EPZ Evacuation.....	A-2
Table 70	Evacuation Model 2: Evacuation for PAGs exceeded beyond the EPZ (SFP release after 40 hours.).....	A-5
Table 71	Evacuation Model 3: Evacuation for PAGs exceeded beyond the EPZ (SFP release after 8 hours). ....	A-7
Table 72	Seismic Bins and Initiating Event Frequencies .....	D-11
Table 73	Frequency of Spent Fuel Pool Fuel Uncovery for Seismic Events .....	D-12
Table 74	Release Frequencies for Spent Fuel Pool Initiators .....	D-14
Table 75	Spent Fuel Pool Release Frequency Estimates.....	D-14
Table 76	Release Frequency Comparison Between Inclusion of All Initiator Event Classes to the Seismic Bin No. 3 Event.....	D-15
Table 77	Consumer Price Index – All Urban Consumers Inflatior.....	D-15
Table 78	Onsite Property Decontamination, Repair, and Refurbishment Costs.....	D-17

Table 79 Average Accident Occupational Exposure at Fukushima Dai-ichi Nuclear Power Plant from March to May 2011 .....	D-19
Table 80 Estimated Immediate Accident Occupational Monthly Exposure at Fukushima .....	D-20
Table 81 Immediate Accident Occupational Exposure for a Spent Fuel Pool Fire .....	D-20
Table 82 Long-Term Accident Occupational Exposure for a Spent Fuel Pool Fire .....	D-21
Table 83 Long-Term Habitability Criterion .....	D-22
Table 84 Habitability Criterion Scaling Factors .....	D-22
Table 85 Economic Consequences Scaling Factors as a Function of Habitability Criteria .....	D-23
Table 86 Number of Spent Fuel Assemblies Remaining through Operating License Expiration .....	D-24
Table 87 Representative Sampling of Commercially Available BWR Spent Fuel Dry Storage Technology .....	D-24
Table 88 Canister Storage Capacity Based on Heat Rate Limitations .....	D-25
Table 89 Amortized DSC Upfront Costs .....	D-26
Table 90 Incremental Unit Cost Estimates .....	D-26
Table 91 Incremental Occupational Dose (Routine) Estimates .....	D-27
Table 92 Regulatory Baseline Loading of Dry Storage Casks .....	D-28
Table 93 Low-density Spent Fuel Pool Case Loading of Dry Storage Casks .....	D-29
Table 94 Summary of Public Health (Accident) for Low-density Spent Fuel Pool Storage [All Initiators] .....	D-31
Table 95 Sensitivity Analyses of Public Health (Accident) Benefits for Low-density Spent Fuel Pool Storage for All Initiating Events (within 50 miles) .....	D-32
Table 96 Sensitivity Analyses of Public Health (Accident) Benefits for Low-density Spent Fuel Pool Storage for All Initiating Events (extending beyond 50 miles) .....	D-32
Table 97 Occupational Health (Accident) Benefits for Low-density Spent Fuel Pool Storage Considering All Initiating Events .....	D-32
Table 98 Occupational Health (Routine) Costs for Low-density Spent Fuel Pool Storage .....	D-33
Table 99 Offsite Property Cost Offsets for Low-density Spent Fuel Pool Storage .....	D-34
Table 100 Summary of Onsite Property Cost Offsets for Low-density Spent Fuel Pool Storage .....	D-35
Table 101 Industry Implementation Cost Model for Low-density Spent Fuel Pool Storage .....	D-36
Table 102 Industry Implementation Costs for Low-density Spent Fuel Pool Storage .....	D-36
Table 103 Summary of Net Benefits for Low-density Spent Fuel Pool Storage Considering All Initiator Events (within 50 miles) .....	D-40
Table 104 Summary of Total Implementation and Operation Costs for Low-density Spent Fuel Pool Storage for All Initiator Events .....	D-41
Table 105 Summary of Total Benefits and Cost Offsets for Low-Density Spent Fuel Pool Storage for All Initiator Events .....	D-41
Table 106 Dollar Per Person-Rem Sensitivity Analysis of Net Benefits for Low-density Spent Fuel Pool Storage Considering All Initiating Events (within 50 miles) .....	D-42
Table 107 Consequences Extending Beyond 50 Miles Sensitivity Analysis of Net Benefits for Low-density Spent Fuel Pool Storage Considering All Initiating Events .....	D-43
Table 108 Combined Sensitivity Analysis that Analyzes Consequences Beyond 50 Miles using a Revised Dollar per Person-Rem Conversion Factor on the Net Benefits for Low-density Spent Fuel Pool Storage for All Initiator Events .....	D-43
Table 109 Public Health (Accident) Person-Rem Averted .....	D-45
Table 110 Facility Employee Exposure .....	D-45
Table 111 Installation and Continuing Costs Associated with the Backfit .....	D-46
Table 112 Summary of Backfitting Net Benefits for Low-density Spent Fuel Pool Storage for All Initiator Events (within 50 miles) .....	D-47
Table 113 Summary of Cost Offsets for Onsite and Offsite Property .....	D-47

Table 114 Combined Sensitivity Analysis of the Backfitting Net Benefits for Low-density Spent Fuel Pool Storage for All Initiator Events (extending analysis beyond 50 miles and using a Revised Dollar per Person-Rem Conversion Factor).....D-48  
Table 115 Summary of Combined Sensitivity Analysis Cost Offsets for Onsite and Offsite Property .....D-48

## ABBREVIATIONS AND ACRONYMS

ac	alternating current
ACRS	Advisory Committee on Reactor Safeguards
AEF	annual exceedance frequency
ANL	Argonne National Laboratory
BEIR	biological effects of ionizing radiation
BEF	biological effectiveness factor
Bq	Becquerel
BWR	boiling-water reactor
C	Celsius
CEC	Commission of the European Communities
CFD	computational fluid dynamics
CFR	Code of Federal Regulations
Ci	curies
Cs	cesium
CSCM	continuous surface cap model
CV	control volume
DBE	design basis earthquake
dc	direct current
DDREF	dose and dose rate effectiveness factor
DF	decontamination factor
DLTEVA	delay to evacuation
DLTSHL	delay to shelter
DOE	U.S. Department of Energy
DURBEG	duration of beginning phase
DURMID	duration of middle phase
E	East
EAL	emergency action levels
EAS	emergency alert system
EPA	U.S. Environmental Protection Agency
EPRI	Electric Power Research Institute
EPZ	emergency planning zone
ESPEED	speed (WinMACCS input variable)
ETE	evacuation time estimate
FAQ	frequently asked questions
FEMA	Federal Emergency Management Agency
FGR	federal guidance report
FSAR	final safety analysis report
GE	General Electric
GEIS	generic environmental impact statement
GI	generic issue
GNF	Global Nuclear Fuel
gpm	gallons per minute
GSI	Generic Safety Issue
GWD	gigawatt-day
HCLPF	high confidence of low probability of failure
HEP	human error probability
hr	hour
HPS	Health Physics Society
HRA	human reliability analysis

I	iodine
ICE	inadvertent criticality event
ICRP	International Commission on Radiological Protection
INL	Idaho National Laboratory
IPEEE	individual plant evaluation for external events
ISFSI	independent spent fuel storage installation
ISRS	in-structure response spectra
K	Kelvin
KI	potassium iodide
LCF	latent cancer fatality
LLNL	Lawrence Livermore National Laboratories
LNT	linear no-threshold
LOOP	loss of offsite power
MACCS2	MELCOR Accident Consequence Code System, Version 2
MCCI	molten core-concrete interaction
MCi	megacuries
MPC	multi-purpose container
MTU	metric tons of uranium
MW	megawatts
MWD	megawatt days
N	North
NCRP	National Council on Radiation Protection and Measurements
NAS	National Academy of Sciences
NRC	Nuclear Regulatory Commission
OCP	operating cycle phase
ORNL	Oak Ridge National Laboratory
ORO	offsite response organization
OSC	operational support center
PAG	protective action guides
PBAPS	Peach Bottom Atomic Power Station
PGA	peak ground acceleration
PPG	pool performance guidelines
PWR	pressurized water reactor
PRA	probabilistic risk assessment
QHO	quantitative health objectives
RB	reactor building
REM	Roentgen Equivalent Man
RHR	residual heat removal
S	South
SAE	site area emergency
SBO	station blackout
SIP	shelter in place
SOARCA	State of the Art Reactor Consequence Analyses
SNL	Sandia National Laboratories
SFP	spent fuel pool
SFPS	Spent Fuel Pool Study
SSC	structures, systems, and components
SSE	safe shutdown earthquake
TSC	technical support center
TSG	technical support guideline
TR	technical report (EPRI technical reports)

USGS  
W

United States Geological Survey  
West

# 1. INTRODUCTION AND BACKGROUND

All operating commercial nuclear reactors in the United States are of the light-water reactor design. They utilize upright fuel assemblies (roughly 12 feet in length) with low-enriched uranium oxide fuel (less than 5-percent uranium-235). The fuel assemblies which are composed of numerous fuel rods (typically 80-100 rods for boiling-water reactor fuel and 200–300 rods for pressurized-water reactor fuel) are placed in the reactor for two to three operating cycles. Each operating cycle typically lasts 18 to 24 months. At the end of their “life,” the assemblies are placed in large pools of water near the reactor that are roughly 12 meters (m) (40 feet (ft)) deep. For facilities licensed to operate an independent spent fuel storage installation (ISFSI), the fuel assemblies are later loaded into casks and moved to the ISFSI as necessary to accommodate future core offloads. The casks are drained of water and inerted with helium during the loading process. This situation leads to the vernacular terms of “wet storage” (to describe storage in the spent fuel pool (SFP)) and “dry storage” (to describe storage in casks).

SFPs in the United States were originally designed to store one to two reactor cores worth of spent fuel, so that the fuel could “cool down” (become less thermally and radioactively “hot”) before its movement to a reprocessing facility or permanent geological repository. Owing to the abandonment of spent fuel reprocessing as well as delays in the identification, licensing and construction of a repository, U.S. nuclear power plants “re-racked” their SFPs in the 1980s and 1990s to allow for the storage of larger numbers of spent nuclear fuel assemblies (i.e., roughly four reactor cores worth for the plant studied in this study). Throughout this time (including present day), the U.S. Nuclear Regulatory Commission (NRC) has maintained that SFPs provide adequate protection of the public health and safety in either low-density or high-density storage configurations. The basis for this position is discussed later in this section.

Stakeholders have periodically challenged the NRC’s position that SFPs provide adequate protection of public health and safety. To understand the basis for these challenges, it’s first necessary to understand two basic facts about spent nuclear fuel:

- (1) Thermal and radioactivity loads associated with freshly discharged fuel necessitate the need for wet storage.
- (2) All spent nuclear fuel, regardless of age (i.e., time since discharge from the reactor), produces both heat and radiation.

The list below presents some less-obvious considerations from the perspective of the benefits and disadvantages associated with transitioning from high-density storage to low-density storage. The list is subdivided into two parts—those considerations that are covered within this study and those that are not.

This study includes the following considerations:

- Removal of older fuel from the SFP will decrease the inventory of longer lived radionuclides, such as cesium-137, present in the SFP.
- Removal of older fuel will result in less radioactive material would be present in the pool if a radioactive release occurred, which would be expected to reduce potential offsite consequences.

- Removal of older fuel reduces the overall heat load in the pool while decreasing the amount of metal mass to act as a heat sink should the fuel become uncovered, which can have competing effects on accident timing depending on the type of accident (e.g., a boiloff event versus a complete draindown).
- Removal of older fuel will increase the area available for air circulation (natural circulation) should the pool become completely drained (the effect of this is somewhat limited by the nature of spent fuel racks as discussed later in this report).
- Removal of older fuel will increase the volume available for cooling water (note that this is mathematically a small effect with the older fuel comprising on the order of 5-percent of the total pool volume—because most of the pool is occupied by water, not fuel).<sup>1</sup>

This study does not explicitly address the following considerations, though some are discussed further in APPENDIX B:

- Discharging large amounts of fuel (and thus greatly increasing the amount of fuel contained in the ISFSI) would increase the number of casks required to store the existing spent fuel inventory.
- Expedited discharging of fuel from the SFP to dry storage increases the frequency of postulated cask drops, which in turn increases the frequency of causing damage to the pool or cask that could lead to a radioactive release.
- Expedited discharging of fuel increases occupational doses for workers involved with the management and transfer of the spent fuel.
- Earlier movement of fuel into casks that are not currently approved for shipping or long-term storage may require that fuel to be repackaged later for shipment to the eventual long-term repository or interim storage site.

Issues related to design-basis accidents and risk posed by dry cask storage have received, and continue to receive, attention from various stakeholders. Issues related to the existing dry cask storage infrastructure, worker dose, and economics are discussed in (NAC, 2011) and (EPRI, 2012). Section 1.6 of this report provides more information on each of these studies.

The first set of bulleted considerations is generally advantages associated with expedited fuel movement to casks, while the latter set of bulleted considerations is generally disadvantages. The agency's position—that spent fuel storage in either pools or casks is safe—is based on a number of past studies and regulatory activities that are discussed later in this chapter. By investigating the pros, we are informing ongoing discussions as to whether fuel movement from spent fuel pools to dry cask storage should be expedited and if any of the “pros” are more

---

<sup>1</sup> The additional water can have a non-intuitive negative impact in certain situations. For a leak at the bottom of the SFP, the additional water at the elevation of the fuel causes it to take longer to “clear” the baseplate (i.e., for the level of the receding water to drop below the bottom of the baseplate). In situations where natural circulation of air under and up through the racks is effective for preventing fuel heatup, this actually temporarily inhibits cooling of the fuel. While this does require a specific set of conditions to be relevant, it is raised here because it does actually arise in one of the scenarios realized later in this report.



compelling than past studies suggest. If they are, then the issue can be addressed more holistically.

## **1.1 Project Impetus**

Various risk studies (most recently NUREG-1738, "Technical Study of Spent Fuel Pool Accident Risk at Decommissioning Nuclear Power Plants," issued February 2001) have shown that storage of spent fuel in a high-density configuration in SFPs is safe and that the risk is low. These studies used simplified and sometimes bounding assumptions and models for characterizing the likelihood and consequences of beyond-design-basis SFP accidents. As part of NRC's security assessments after the events of September 11, 2001, SFP modeling using detailed thermal-hydraulic and severe accident progression models integrated into the MELCOR code were developed and applied to assess the realistic heatup of spent fuel under various pool draining conditions. Moreover, in conjunction with these post-9/11 security assessments, the NRC issued a new regulation, 10 CFR 50.54(hh)(2), that requires reactor licensees to develop and implement guidance and strategies intended, in part, to maintain or restore SFP cooling capabilities following certain beyond design basis events.

Recently, the agency has restated its views on the safety of spent fuel stored in high-density configurations in a response to Petition for Rulemaking (PRM)-51-10 and PRM-51-12 as well as the revision to NUREG-1437, Revision 1, "Generic Environmental Impact Statement for License Renewal of Nuclear Plants - Draft Report for Comment," issued July 2009. However, this position relies in part on the findings of the aforementioned security assessments, which are not publicly available. The renewed interest in spent fuel storage engendered from the changes in the path forward of the planned geologic repository and from the events in Japan following the March 2011 earthquake has rekindled interest in capturing the consequences from postulated accidents associated with high-density SFP storage in an updated safety study.

The spent fuel pool study's (SFPS) primary objective was to determine if accelerated transfer of spent fuel from the spent fuel pool to dry cask storage provides a substantial safety enhancement for the reference plant. The insights from this analysis will inform a broader regulatory analysis of the SFPs at U.S. nuclear reactors as part of the Japan Lessons-learned Tier 3 plan. NRC analyzes low likelihood (beyond the design basis) events to estimate risk to the public and to explore and ensure safety margins. The results of the study will be used to inform the evaluation of what future regulatory actions the NRC might undertake, including whether expedited transfer of spent fuel from spent fuel pools into dry cask storage is justified. To help inform whether regulatory action needs to be taken in this area, the NRC has prepared an example of a regulatory analysis of the reference plant studied in this report (see APPENDIX D). A regulatory analysis is an analytical tool used by NRC decision-makers to help determine whether the NRC should implement a proposed regulatory action. The regulatory analysis is intended to inform NRC decision makers whether there is a substantial increase in the overall protection of the public health and safety, and whether the direct and indirect costs of implementation are justified in view of a potential substantial increase in protection. For the example regulatory analysis, the Spent Fuel Pool Study (SFPS) results are used as quantitative inputs to the safety goal screening criteria in accordance with the NRC regulatory analysis guidelines (NUREG/BR-0058), wherein the quantitative health objectives are used as a surrogate of the safety goal. The example regulatory analysis also contains estimates of benefits and costs, which are quantified when possible, together with a conclusion as to whether the proposed regulatory action is cost-beneficial. "Cost-beneficial" means that the benefits of the proposed action are equal to, or exceed, the costs of the proposed action. Accident consequences such as land interdiction and population relocation reported in this study are

used to estimate the costs resulting from an accident (e.g., costs of interdiction measures, such as decontamination, cleanup, and evacuation) as part of the cost-benefit analysis.

Other aspects of SFP risk that have not been informed by this or past studies, may be addressed by future studies, such as the site Level 3 probabilistic risk assessment (PRA), as documented in SECY-11-0089, "Options for Proceeding with Future Level 3 Probabilistic Risk Assessment Activities," dated July 7, 2011, and the associated staff requirements memorandum; or will be addressed through other inputs to the regulatory decision-making process, as needed.

## **1.2 Technical Approach**

Two broad situations are considered in this study, which represent the following:

- (1) A condition representative of the following: (i) high-density loading in the SFP using a 1x4 pattern (see Figure 34 for an illustration of what is meant by this terminology), (ii) a relatively full SFP, and (iii) current regulatory requirements relating to fuel configuration and preventive/mitigative capabilities; and
- (2) A condition where fuel with more than 5 years of cooling has been moved to dry cask storage (i.e., low-density loading in the SFP and current applicable regulatory requirements with respect to fuel configuration and preventive/mitigative capabilities).

For purposes of obtaining a near-term perspective on the issue, a single site and single assumed operating cycle are used. The site characterization (e.g., seismic response, decay heat, radionuclide inventory) is based on readily available information that primarily stemmed from sources such as the study reported in NUREG-1150, "Severe Accident Risks: An Assessment of Five Nuclear Power Plants," issued December 1990; seismic information developed by the U.S. Geological Survey (USGS); the post-9/11 security assessments<sup>2</sup>; and the State-of-the-Art Reactor Consequence Assessment (SOARCA) described in NUREG-1935. Later in the project, the licensee provided additional information that generally corroborates the assumptions made in this study.

A BWR plant was chosen for this analysis for a mix of reasons including availability of computer models for a BWR plant, a perception of greater external stakeholder interest in elevated (relative to grade) SFPs<sup>3</sup>, and the fact that the nuclear reactors that felt the higher tsunami waves and stronger ground motions from the March 11, 2011, Tohoku earthquake, which includes those at Fukushima Daiichi, were all BWR reactors. In the context of a seismic event, the elevation of the pool will affect the transmission of seismic loads through the structure, can potentially inhibit accessibility for taking mitigative action, and can potentially lead to flooding of safety-related equipment, if the pool and surrounding structures are significantly damaged. The selection of a BWR design is not intended to suggest that these designs are more vulnerable to

---

<sup>2</sup> The post 9/11-security assessments included consideration of SFPs and resulted in the collection of information and the development of computer models that provided a convenient starting point for the current study.

<sup>3</sup> SFPs at pressurized water reactor and BWR/6s (which have Mark III containments) are generally at or near grade elevation, with many being partially below grade. In the Mark I and Mark II designs, the SFP is oriented such that the top of the SFP is at the same elevation as the top of the primary containment vessel, which results in them being well above grade.

SFP accidents. In reality, there are differences between the major design types (PWRs versus BWRs) that make each more or less susceptible to SFP accidents on a scenario-specific basis. Similarly, the selection of a site that has a separate SFP for each reactor (as opposed to a shared pool) is also not intended to suggest that these situations are inherently more vulnerable.

### **1.3 Site Specificity and Familiarization**

This study is intentionally based on plant-specific information for a particular site, as opposed to attempting to define a generic site that might bound a set of plants. This approach was taken because it provides the best context for examining SFP accident progression and release phenomenology in a realistic fashion, for the purpose of providing a better understanding of the factors that affect the characterization of SFP beyond-design basis accidents. The decision to proceed in this manner was deliberately made in reaction to persistent criticisms regarding the realism of past studies (due to their goal of broad applicability in order to support their intended purposes). Because this study strives to be site-specific, it does not account for the variability in design and operation across the operating fleet, but rather, represents one point within that spectrum.

In almost all situations where plant-specific design and operational information is used, it is based on Unit #3 of the Peach Bottom Atomic Power Station (PBAPS), circa 2011. Nevertheless, the SFPS makes some assumptions that are not representative of PBAPS because either (a) insufficient information was available at the time the modeling decision was made or (b) the PBAPS situation was viewed to be atypical. Regarding the former exception, the initial phase of the work was expedited to achieve early insights. Some modeling assumptions were confirmed in parallel to ongoing work, and in instances where newer information provided additional perspective on the modeling assumption, this is noted in the report. Regarding the second exception, the major example of this is that the study assumed the fuel is configured in a 1x4 pattern rather than in the 1x8 pattern used at PBAPS as discussed further in Section 5.1. In some situations, the 1x8 pattern is predicted to have a beneficial effect on the amount of radiation released (Section 9.2). Additionally, sensitivity analyses presented in Chapter 9 explore the effect of some important parameters on the study results. Due to these exceptions, the analysis contained in this report is best described as being performed for a “reference plant” which is largely based on PBAPS.

PBAPS has two General Electric (GE) Type 4 BWRs with Mark I containments, Units #2 and #3. This study uses Unit #3 when unit-specific information is required. Unit #1 is no longer in operation. Units #2 and #3 each have a dedicated SFP, and the pools do not share a common refueling floor, as is the case with some plants of this design. Most other aspects of the reactor, SFP, and reactor building are similar to BWR designs of this vintage. Two small power uprates have been approved for this site (1995 and 2002), with an extended power uprate submittal currently under review (as of January 2013).

Regarding the SFPs, the existing high-density racks were placed in service in 1986, and were designed and manufactured by Westinghouse Electric Corporation. As of 2010, the Unit #3 SFP contained 2,945 assemblies, while the Unit #2 SFP contained 2,844. Both SFPs maintain enough open locations to allow for an emergency full core offload, if needed. The site also has an ISFSI for dry cask storage, utilizing the TN-68 cask design.

Finally, with respect to emergency preparedness, the site is located in a State (Pennsylvania) that has State-specific protective action guidelines. Detailed site-specific information relevant

for this study is covered in the remainder of this report, including figures that show the reactor building layout, SFP layout, etc.

#### **1.4 Basic Scenario Development**

The following key aspects of the way this study is conducted should be mentioned at this point.

- A large seismic event is the only initiator considered.
- As mentioned previously, both the current situation (a high-density loading configuration in the pool) and an alternate situation (a low-density loading configuration in the pool) are analyzed. A situation in which the pool has been re-racked to a low-density rack configuration is not considered, because such a situation would be inefficient in terms of regulatory benefit given that much of the benefit of this situation could be achieved by storing less fuel in the existing racks (it should be mentioned that BWR fuel is channeled, which reduces the benefit of cross-flow if the pool were to become drained).
- The study focuses on the SFP, not the reactor, though for instances in which the two are hydraulically connected, both are considered to a certain extent.
- In estimating the likelihood and consequences of radiological release, the study does not attempt to quantify the likelihood of successful deployment of mitigation, but rather treats every scenario considering both the case with successful mitigation deployment and the case with unsuccessful mitigation deployment (also referred to as mitigated and unmitigated later in the report)<sup>4</sup>. These results are then used to drive a human reliability analysis (Chapter 8) which provides information about what plant conditions impact mitigative reliability, and what range of likelihoods are expected.
- All portions of the operating cycle are considered.
- Detailed computer modeling is used to predict the plant's response to the event, in terms of structural response, accident progression, mitigation effectiveness (when credited), and offsite consequences.

In cases in which the above represent limitations on the study's scope or results, these are justified in this report. In particular, Chapter 2 of this report provides the study's key limitations and assumptions.

#### **1.5 Rationale for Focusing on Consequences of a Seismic Hazard**

This section seeks to provide context regarding the suite of potential initiating events that can lead to an SFP accident, and why the consequences of a seismic event is the focus of this study.

This study is a limited-scope consequence assessment that utilizes probabilistic insights. By looking at these probabilistic aspects, the results can be placed in better context, by means of the limited treatment of relative likelihood. While these elements provide some of the benefits of

---

<sup>4</sup> Note that the shorthand of "mitigated" and "unmitigated" still refers to whether mitigative actions are successfully deployed, not whether the accident itself leads to a release.

an actual risk assessment, there are several elements of a risk assessment that are specifically not performed. These include the following:

- failure modes and effects analysis (except for SSCs specifically discussed in this Chapter)
- data analysis and component reliability (e.g., consideration of random failures)
- effects of dependencies
- HRA as part of the accident progression and recovery; a limited scope HRA is performed in (Chapter 8
- system fault tree and sequence event tree development and quantification

Even so, this study does attempt to bring probabilistic insights to bear. In terms of inputs to the study, these include the following:

- risk information from past studies for selecting the scenarios studied
- initiating event likelihood
- initiating event timing effects (e.g., the relative likelihood of having an event during the various operating cycle phases and the likely configurations incurred)
- relative likelihood of damage state characteristics and conditional probabilities associated with offsite consequence analysis (e.g., meteorological sampling in MACCS2 analysis)

In terms of assessing the results, the consideration of probabilistic insights uses the above inputs (and simple algebraic combination) to quantify different figures of merit to put the results in context.

The inclusion of probabilistic aspects within the current study allows the study to consider some aspects of likelihood, but will not support definitive statements on risk. To elaborate, this study focuses on a specific portion of the overall risk profile, that of large seismic events between 0.5 and 1g. In comparing the results of this study to those of previous studies, one can corroborate or challenge the continued applicability of prior estimates for this piece of the risk profile. Since large seismic events have been shown in the past to be a prominent contributor to risk, this comparison helps to predict whether a comprehensive risk assessment would be expected to result in an overall decrease or increase in the estimated risk. Using this approach, the results of this study can draw supportable, but not definitive, conclusions about overall consequences and risk.

For the present study, because of (1) the relative simplicity of the SFP and its supporting infrastructure as compared to a reactor and its supporting infrastructure and (2) the much lower assembly decay heats, the majority of potential SFP accident risk is believed to emanate from either of the following two events:

- (1) events that have the potential to cause a sizable leak in the SFP

- (2) events that might preclude operator action to cool or inject water into the pool for an extended period of time (i.e., days)

When one considers the various possible initiators, the first criterion points to the following:

- (1) very large (i.e., well beyond the design-basis) seismic events (Note that these events almost certainly initiate a loss-of-offsite power and may fail emergency on-site power.)
- (2) heavy load (e.g., cask) drops
- (3) inadvertent aircraft crashes

In addition to these, the second criterion also points to the following:

- (4) extended loss-of-offsite power (LOOP) events caused by severe weather (e.g., severe storms, hurricanes, tornados), within design-basis seismic events or other grid upsets, with concurrent loss of emergency onsite alternating current (ac) power (either because of the same event or because of coincidental hardware failures)
- (5) lack of accessibility caused by a reactor accident that has released radioactive material outside of primary containment (or an accident involving the other SFP)

Note that sabotage events have been excluded from the scope of this study.

Items #(1) (seismically-induced station blackout), #(2) (cask drops), and #(4) (extended LOOPS) have been considered in most other SFP studies, and are discussed further below. For item #(3), past studies (namely NUREG-1738 (NRC, 2001)) have concluded that the risk of this initiator is bounded by other initiators for both PWRs and BWRs, based on quantitative estimates of likelihood and expected damage (see Section 3.5.2 of that study). Item #(5) (effects of a concurrent reactor accident) generally have not been studied in prior efforts. The frequency and consequences of a reactor accident is not considered and the effect of a reactor accident on a spent fuel pool scenario is partially considered here, but not rigorously (see Section 2.2 of this study for more information).

Past studies have had generally similar conclusions about the relative contribution to risk from the various initiating events considered. Table 1 summarizes fuel uncover frequencies from NUREG-1353, "Regulatory Analysis for the Resolution of Generic Issue 82, "Beyond Design Basis Accidents in Spent Fuel Pools,"" issued April 1989, and NUREG-1738. For both NUREG-1738 and NUREG-1353, seismic events were the largest contributor to the frequency of fuel uncover.

**Table 1 Frequency of SFP Fuel Uncovery (/yr)**

<b>Initiating Event Class</b>	<b>NUREG-1353 (1989) (BWR, best-estimate<sup>1</sup>)</b>	<b>NUREG-1738 (2001)</b>
Seismic events	$7 \times 10^{-6}$	$2 \times 10^{-6}$ (LLNL) $2 \times 10^{-7}$ (EPRI) <sup>2</sup>
Cask / heavy load drop	$3 \times 10^{-8}$	$2 \times 10^{-7}$
LOOP – severe weather	-	$1 \times 10^{-7}$
LOOP – other	-	$3 \times 10^{-8}$
Internal fire	-	$2 \times 10^{-8}$
Loss of pool cooling	$6 \times 10^{-8}$	$1 \times 10^{-8}$
Loss of coolant inventory	$1 \times 10^{-8}$	$3 \times 10^{-9}$
Inadvertent aircraft impacts	$6 \times 10^{-9}$	$3 \times 10^{-9}$
Missiles – general	$1 \times 10^{-8}$	-
Missiles - tornado	-	$< 1 \times 10^{-9}$
Pneumatic seal failures	$3 \times 10^{-8}$	-

<sup>1</sup> These numbers have not been multiplied by the stated conditional probability of having a Zirconium fire of 0.25.

<sup>2</sup> NUREG-1738 presented results for the two different seismic hazard models in wide use at the time (the Electric Power Research Institute (EPRI) and Lawrence Livermore National Labs (LLNL) models).

For these reasons, a seismic event was judged to be the logical focus of this limited-scope consequences assessment. Based on a review of the seismic hazard for the particular site studied, and consideration of seismic hazard binning from contemporary seismic PRA methodologies, a specific range of ground motions was chosen for this study (see Chapter 3). This range of ground motions represents a good compromise between more likely events that would not be expected to lead to any consequences and less likely events that would lead to greater consequences (risk is the product of the likelihood times the consequences).

## **1.6 Operating Cycle Phase Approach**

During a given operating cycle, the spent fuel pool:

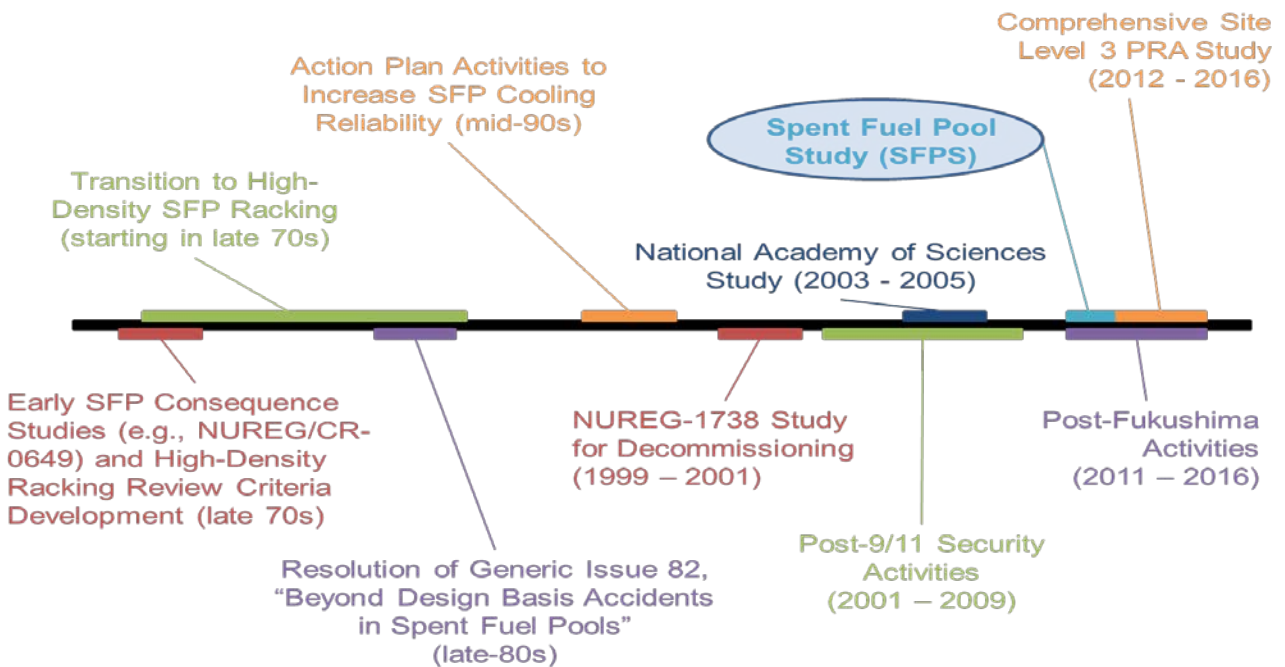
- will change configuration from an isolated pool to a pool that is hydraulically connected to the reactor vessel (and back again)—these configurations will be referred to as pool-reactor configurations to distinguish from the different spent fuel loading configurations;
- may have spent fuel temporarily offloaded from the reactor;
- will have spent fuel permanently offloaded from the reactor;
- will likely have spent fuel moved around within the SFP (as part of complying with regulatory requirements related to heat distribution, criticality, and neutron absorber monitoring)
- may have older spent fuel offloaded into storage casks and transferred to an ISFSI;
- will experience changes in the peak assembly fission product decay power (of interest for draindown events and spray mitigation) because of the above considerations as well as radioactive decay; and

- will experience changes in the total decay power of all assemblies (of interest for pool heatup/boiling and makeup mitigation) because of the above considerations as well as radioactive decay.

To rigorously represent these changing conditions, the study breaks up the operating cycle into numerous small periods of time or operating cycle phases (OCPs). However, the number of OCPs considered is nearly a linear multiplier on the amount of resources needed because each period of time requires its own set of accident progression and consequence analyses. Past studies have taken the approach of selecting specific points in time of interest, and comparing results for those specific times. This study takes a similar approach, but places more emphasis on the definition of these times as quasi-steady representations of the portion of the operating cycle that they represent. This approach allows for more accurate representation of the annualized frequencies of offsite consequences. The specific selection of these phases is described further in Section 5.2 of this report.

## 1.7 Overview of Past Studies

A number of past studies have been performed to look at various aspects of spent fuel and SFP safety, security, and risk. The major regulatory activities are shown in Figure 1. A more comprehensive chronicling of these past studies, as well as other aspects of general interest pertinent to the current effort, are briefly described in the ensuing text.



**Figure 1 Graphical overview of significant SFP-related activities**

In March 1979, the NRC issued NUREG/CR-0649, "Spent Fuel Heatup Following Loss of Water During Storage," which provided an analysis of spent fuel heatup following a hypothetical accident involving drainage of the storage pool (NRC, 1979). The report included analysis to assess the effect of decay time, fuel element design, storage rack design, packing density, room ventilation, drainage level, and other variables on the heatup characteristics of spent fuel stored in an SFP and to predict the conditions under which clad failure would occur. The report



concluded that the likelihood of clad failure caused by rupture or melting following a complete drainage is extremely dependent on the storage configuration and the spent fuel decay period. Furthermore, the minimum prerequisite decay time to preclude clad failures may vary from less than 10 days for some storage configurations to several years for others. The potential for reducing this critical decay time either by making reasonable design modifications or by providing effective emergency countermeasures was found to be significant. Note that this study considered both low-density racking and mitigative accessibility.

In the late 1980s, work related to Generic Issue (GI)-82, "Beyond Design Basis Accidents in Spent Fuel Pools," culminated in the publishing of several related reports: NUREG/CR-4982, "Severe Accidents in Spent Fuel Pools in Support of Generic Safety Issue 82," issued July 1987 (NRC, 1987), NUREG/CR-5281, "Value/Impact Analysis of Accident Preventive and Mitigative Options for Spent Fuel Pools," issued March 1989 (NRC, 1989a), and NUREG-1353, "Regulatory Analysis for the Resolution of Generic Issue 82, 'Beyond Design Basis Accidents in Spent Fuel Pools,'" (NRC, 1989b). In particular, NUREG/CR-5281 investigated options including limited low-density re-racking of spent fuel, installation of water sprays above the SFP, and installation of redundant cooling, makeup systems, or both. The results of these studies indicated that the measures were, in general, not likely to be cost effective because of the low likelihood of an SFP accident that could result in a significant radiological release and the high cost of proposed modifications. The report goes on to conclude that these insights are largely contingent upon compliance with guidelines developed for licensees to ensure the safe handling of heavy loads in the vicinity of SFPs, thus reducing the likelihood of the structural failure of the pool and rapid loss of water inventory resulting from a cask drop event.

The latter report (NUREG-1353), which draws from the preceding reports, concludes that if the decay heat level is high enough to heat the fuel rod cladding to about 900 degrees Celsius (C) the oxidation becomes self-sustaining, resulting in a Zircaloy cladding fire. The conditional probability of a Zircaloy cladding fire given a complete loss of water was found to be 1.0 for PWRs and 0.25 for BWRs in high-density configurations based on differences in assumed rack geometry. The conditional probability of a Zircaloy cladding fire given a complete loss of water in low-density storage racks is estimated to be at least a factor of five less than for the high-density configurations. The report goes on to state that although most of the SFP risk is derived from beyond-design-basis earthquakes, this risk is no greater than the risk from core damage accidents caused by seismic events beyond the safe-shutdown earthquake (SSE). Therefore, reducing SFP risk resulting from events beyond the SSE would still leave at least a comparable risk from core damage accidents. As a result of this conclusion, the results justified the decision that no regulatory action was needed.

In 1996, an NRC-sponsored and issued an Idaho National Laboratories (INL) study entitled, "Loss of Spent Fuel Pool Cooling PRA: Model and Results," (INL, 1996). This study considered a dual-unit plant and the following initiators:

- loss of SFP cooling
- LOOP
- loss of SFP water inventory (did not include heavy load drops)
- loss of primary (reactor) coolant
- seismic events

The results of this study indicated that, for the plant studied, the annual probability of SFP boiling is  $5 \times 10^{-5}$  and the annual probability of internal plant flooding associated with SFP

accidents is  $1 \times 10^{-3}$ . Qualitative arguments are provided to show that the likelihood of core damage from SFP boiling accidents is low for most U.S. commercial nuclear power plants. The INL study also showed that, depending on the design characteristics of a given plant, the likelihood of either (1) core damage from SFP-associated flooding or (2) spent fuel damage from pool dryout may not be negligible. Section 6.3.4 further discusses this issue.

The next year, three additional reports were issued: (1) NUREG-1275, Volume 12, "Operating Experience Feedback Report: Assessment of Spent Fuel Cooling," (NRC, 1997a), (2) "Follow-up Activities on the Spent Fuel Pool Action Plan," (NRC, 1997b), and (3) NUREG/CR-6451, "A Safety and Regulatory Assessment of Generic BWR and PWR Permanently Shutdown Nuclear Power Plants," (NRC, 1997c). The first of these reports concluded that the typical plant may need improvements in SFP instrumentation, operator procedures and training, and configuration control. (Note that this is the conclusion stated in the report, and has not been placed in the regulatory context of balance-of-plant activities since the issuance of that report.) The staff determined that loss of SFP coolant inventory greater than 1 foot occurred at a rate of about one event per 100 reactor years. Loss of SFP cooling with a temperature increase greater than 20 degrees Fahrenheit (F) occurred at a rate of approximately three events per 1,000 reactor years. The primary cause of these events was found to be human error. The report also concluded that utilities' efforts to reduce outage duration resulted in full core offloads occurring earlier in outages. This increased fuel pool heat load was felt to be important because it reduces the time available to recover from a loss of SFP cooling event early in the outage.

In the second of these reports (known as the Spent Fuel Pool Action Plan), the staff performed probabilistic screening analyses and found that, in most cases, event frequencies for sequences associated with identified SFP design issues were sufficiently low that further analyses were not warranted. In one instance in which the probabilistic screening criteria were met, the staff performed a deterministic evaluation of the issue using plant-specific information and found that safety enhancements were not warranted.

The third report (NUREG/CR-6451) presents a regulatory assessment for generic BWR and PWR plants that have permanently ceased operation. In addition to an assessment of regulatory requirements in the context of decommissioning, this study looked at the potential offsite consequences for four phases of decommissioning (hot fuel in the SFP, cold fuel in the SFP, all fuel in dry cask storage, and no spent fuel onsite). The following conclusions are based on an assumption that for the second configuration (cold fuel in the SFP), a zirconium fire would not occur, and that consequences are driven by an accident where a single fuel assembly is dropped during movement within the SFP (akin to the design-basis fuel handling accident). The report concluded that, "Since the estimated consequences of the Configuration 1 representative accident sequence approximate those of a core damage accident, it is recommended that all offsite and onsite emergency planning requirements remain in place during this period, with the exception of the Emergency Response Data System requirements of Part 50, Appendix E. Subject to plant specific confirmation, the offsite emergency preparedness (EP) requirements are expected to be eliminated for Configuration 2, on the basis of a generic boundary dose calculation. Part 50 offsite EP requirements can also be eliminated for Configurations 3 and 4 because the spent fuel has been transferred to an ISFSI (subject to Part 72 requirements) or transported offsite."

Several years later, the NRC re-visited these issues by conducting an SFP risk study for decommissioning plants to look at the relaxation of emergency preparedness requirements, and in 2001 the final version was issued as NUREG-1738 (NRC, 2001). The results of the study indicated that the risk at SFPs is low and well within the Commission's quantitative health

objectives (QHOs). The risk was found to be low because of the very low likelihood of a zirconium fire, even though the consequences from a zirconium fire could be serious. The report found that the event sequences important to risk at decommissioning plants were limited to large earthquakes and cask drop events. This report represented a significant undertaking, and remains one of the prominent studies cited in NRC decision-making on SFPs. However, there are some important conservatisms associated with this study that need to be considered if it is applied outside of its intended context (e.g., exemption requests from NRC requirements for offsite emergency preparedness for decommissioning reactors). These conservatisms include: (1) the use of assumed and often bounding configurations, (2) simplified treatment of the thermal-hydraulic response, (3) simplifying assumptions regarding the pool failure leakage rate for large seismic event and cask drop (i.e., instantaneous draindown), and (4) emergency preparedness response representative of a decommissioned site.

On the heels of the aforementioned study, the agency also released NUREG/CR-6441 in March 2002, entitled, "Analysis of Spent Fuel Heatup Following Loss of Water in a Spent Fuel Pool: A Users' Manual for the Computer Code SHARP," (NRC, 2002a). This document included an analysis of spent fuel heatup, using "representative" design parameters and fuel loading assumptions. Sensitivity calculations were also performed to study the effect of fuel burnup, building ventilation rate, baseplate hole size, partial filling of the racks, and the amount of available space to the edge of the pool. The spent fuel heatup was found to be strongly affected by the total decay heat production in the pool, the availability of open spaces for airflow, and the building ventilation rate. Note that the SFP analyses performed by the NRC after this time did not rely on this computer code. Rather, they relied on the use of the MELCOR computer code (owing to its mechanistic treatment of severe accident phenomena), with supporting analysis using the COBRA-SFS, FLOW3D and Fluent codes, along with confirmatory experiments at Sandia National Laboratories (SNL).

In response to the events of September 11, 2001, the NRC undertook studies (referred to hereafter as security assessments) of spent fuel storage in pools and casks. While this work was underway, Robert Alvarez et al. published the paper, "Reducing the Hazards from Stored Spent Power-Reactor Fuel in the United States," dated April 21, 2003 (hereafter referred to as the 2003 Alvarez paper) (Alvarez et al., 2003). In response, the NRC issued a review of the paper (also in 2003) which concluded that the assessment performed of possible SFP accidents stemming from potential terrorist attacks in the 2003 Alvarez paper did not address such events in a realistic manner (NRC, 2003a). The NRC response went on to state that, in many cases, the authors of the 2003 Alvarez paper relied on studies that made overly conservative assumptions or were based on simplified and very conservative models. The NRC concluded that the fundamental recommendation of the 2003 Alvarez paper, namely that all spent fuel more than 5 years old be placed in dry casks through an expedited 10-year program costing many billions of dollars, was not justified.

Continued discussions on the issue of SFP safety and security led to a 2004-2005 National Academies study, documented in "Safety and Security of Commercial Spent Nuclear Fuel Storage," issued in 2006 (NAS, 2006). This study was Congressionally mandated (e.g., see [Congress, 2005]). The National Academies committee was briefed on numerous occasions by the NRC staff regarding past and ongoing studies related to the subject topic. The study resulted in a classified report and the aforementioned publicly available report. The publicly available report documented numerous findings and recommendations, many of which were addressed as part of the NRC's continued activities in this area (e.g., site-specific assessments of licensee response to develop strategies to maintain or restore SFP cooling capabilities).

The NRC's initial response to the study was documented in a letter from the NRC Chairman (Nils Diaz) to Senator Peter Domenici, dated March 14, 2005 (NRC, 2005a). In that response, NRC expressed its appreciation for the insights of the National Academies committee, noting that many of the conclusions mirrored the NRC's conclusions from prior work, which guided NRC initiatives. However, the NRC disagreed with some of the conclusions from the National Academies study, including the finding that the NRC might determine that the earlier movement of spent fuel from pools to dry cask storage would be prudent, depending on the outcome of plant-specific vulnerability analysis. "The Commission views the results of security assessments completed to date as clearly showing that storage of spent fuel in both SFP and in dry storage casks provides reasonable assurance that public health and safety, the environment, and the common defense and security will be adequately protected. The NRC will continue to evaluate the results of the ongoing plant-specific assessments and, based upon new information, would evaluate whether any change to its spent fuel storage policy is warranted." The NRC's position on each finding or recommendation that it disagreed with is contained in the report to Congress that accompanied the March 2005 letter.

In parallel to the National Academies study, the NRC continued performing the aforementioned security assessments, which were completed in 2006-2008. While the results of these studies are not publicly available because of their nature (i.e., containing sensitive information that could be useful to an adversary), the conclusions of the studies were integrated into the NRC's regulatory licensing and oversight processes (e.g., 10 CFR 50.54(hh)(2) as a result of the Power Reactor Security Rulemaking). Activities related to the development of new security-related requirements were later documented in a memorandum to the NRC Commission entitled, "Documentation of Evolution of Security Requirements at Commercial Nuclear Power Plants with Respect to Mitigation Measures for Large Fires and Explosions," dated February 4, 2010 (NRC, 2010).

Also in parallel to the above activities, the agency conducted a pilot PRA for dry cask storage documented in NUREG-1864, "A Pilot Probabilistic Risk Assessment of a Dry Cask Storage System at a Nuclear Power Plant," issued March 2007 (NRC, 2007). The report's analysis indicates that dry cask storage risk is solely from latent cancer fatalities, and no prompt fatalities are expected. Dry cask storage risk was found to be dominated by accident sequences occurring in three stages of the handling phase. These involved the drop of the transfer cask through the equipment hatch (termed Stage 18) and drops of the multipurpose canister (MPC) into the storage overpack (Stages 20 and 21). The aggregated risk values were quite low. The estimated aggregate risk was an individual probability of a latent cancer fatality of  $1.8 \times 10^{-12}$  during the first year of service, and  $3.2 \times 10^{-14}$  per year during subsequent years of storage. Note that when insufficient information was available, "conservative bounding assumptions or estimates" were used. Other limitations of the study included no consideration of uncertainty and conservative assumptions about the translation of failure modes to leak sizes.

Two other documents of regulatory interest were issued in 2008 and 2009. The first was the denial of two PRMs, as documented in SECY-08-0036, "Denial of Two Petitions for Rulemaking Concerning the Environmental Impacts of High-Density Storage of Spent Nuclear Fuel in Spent Fuel Pools (PRM-51-10 and PRM-51-12)," dated March 7, 2008, and the associated staff requirements memorandum (NRC, 2008a). These documents describe the NRC's denial of PRMs filed by the Attorney General of the Commonwealth of Massachusetts and the Attorney General for the State of California, which presented nearly identical issues and requests for rulemaking concerning the environmental impacts of high-density storage of spent nuclear fuel in SFPs.

The second document is the issuance in 2009 of the draft report for comment of Revision 1 to the NRC's Generic Environmental Impact Statement (GEIS) on License Renewal (NUREG-1437, Revision 1 (NRC, 2009)). This document reevaluated SFP environmental considerations related to SFPs by considering information developed since the original license renewal GEIS was issued in 1996 (NRC, 1996). The update concluded that the environmental impacts from accidents at SFPs (as quantified in NUREG-1738) can be comparable to those from reactor accidents at full power (as estimated in NUREG-1150 (NRC, 1990)). The updated GEIS goes on to state that subsequent analyses performed, and mitigative measures employed, since 2001 have further lowered the risk of SFP accidents; and even the conservative estimates from NUREG-1738 are much less than the impacts from full power reactor accidents as estimated in the original 1996 GEIS. As a result of these considerations, the update concludes that the environmental impacts stated in the 1996 GEIS bound the impact from SFP accidents.

Finally, in July 2011, the NRC issued, "Recommendations for Enhancing Reactor Safety in the 21<sup>st</sup> Century: The Near-Term Task Force Review of Insights from the Fukushima Daiichi Accident" (NRC, 2011a). This report makes two sets of conclusions and recommendations related to spent fuel pool safety. The first occurs in the section of the report on prolonged loss of ac power. In this section, the task force stated the following:

The Commission's [station blackout] SBO requirements provide assurance that each nuclear power plant can maintain adequate core cooling and maintain containment integrity for its approved coping period (typically 4 or 8 hours) following an SBO. Also, if available, the equipment used for compliance with 10 CFR 50.54(hh)(2) would provide additional ability to cool either the core or the spent fuel pool and mitigate releases from primary and secondary containment during a prolonged SBO. The implementing guidance for SBO focuses on high winds and heavy snowfalls in assessing potential external causes of loss of offsite power, but does not consider the likelihood of loss of offsite power from other causes such as earthquakes and flooding. Also, the SBO rule does not require the ability to maintain reactor coolant system integrity (i.e., PWR reactor coolant pump seal integrity) or to cool spent fuel....

The Task Force concludes that revising 10 CFR 50.63 to expand the coping capability to include cooling the spent fuel, preventing a loss-of-coolant accident, and preventing containment failure would be a significant benefit.

The task force went on to recommend orders requiring reasonable protection of the equipment provided pursuant to 10 CFR 50.54(hh)(2) and the acquisition of additional sets of equipment as needed to address multiunit events. The task force also recommended a rulemaking

to revise 10 CFR 50.63 to require each operating and new reactor licensee to (1) establish a minimum coping time of 8 hours for a loss of all ac power, (2) establish the equipment, procedures, and training necessary to implement an "extended loss of all ac" coping time of 72 hours for core and spent fuel pool cooling and for reactor coolant system and primary containment integrity as needed, and (3) preplan and prestage offsite resources to support uninterrupted core and spent fuel pool cooling, and reactor coolant system and containment integrity as needed, including the ability to deliver the equipment to the site in the time period allowed for extended coping, under conditions involving significant degradation of offsite transportation infrastructure associated with significant natural disasters.

The second set of conclusions and recommendations is included in the section of the report on SFP Safety, where the task force concluded the following:

clear and coherent requirements to ensure that the plant staff can understand the condition of the spent fuel pool and its water inventory and coolability and to provide reliable, diverse, and simple means to cool the spent fuel pool under various circumstances are essential to maintaining defense-in-depth.

The task force goes on to recommend orders addressing: (1) SFP instrumentation, (2) safety-related ac power for SFP makeup, (3) technical specification revision regarding onsite ac power for SFP makeup and instrumentation, and (4) a seismically-qualified spray capability. The task force also recommended rulemaking or licensing actions (or both) to require the above actions.

The U.S. nuclear industry has also undertaken various studies related to spent fuel storage and transportation. Examples include the following:

- Electric Power Research Institute (EPRI) TR-1003011, “Dry Cask Storage Probabilistic Risk Assessment Scoping Study,” issued in 2002
- EPRI TR-1009691, “Probabilistic Risk Assessment (PRA) of Bolted Storage Casks: Updated Quantification and Analysis Report,” issued in 2004
- EPRI TR-1021049, “Impacts Associated with Transfer of Spent Nuclear Fuel from Spent Fuel Storage Pools to Dry Storage After Five Years of Cooling,” issued in 2010
- EPRI TR-1025206, “Impacts Associated with Transfer of Spent Nuclear Fuel from Spent Fuel Storage Pools to Dry Storage After Five Years of Cooling, Revision 1,” issued in 2012

The last two reports are of particular interest for the present effort. EPRI TR-1021049 assesses the cost and risk impacts (from a worker dose perspective) associated with transfer of spent nuclear fuel from SFPs to dry storage after 5 years of cooling. The report concludes that expedited fuel movement would result in an increase cost to the U.S. nuclear industry of \$3.6 billion, with the increase primarily related to the additional capital costs for new casks and construction costs for the dry storage facilities. The report goes on to conclude that early movement of spent fuel into dry storage would have “significant radiological impacts.” These impacts are stated in terms of worker radiation exposure, and are estimated to be 507 person-rem over 60 years as a result of the additional handling of spent fuel. With respect to SFP accidents, the report estimates that an additional 711 dry storage packages would have to be handled, as compared to the case without expedited fuel movement, thus increasing the risks associated with cask movement (based on a need to reduce the number of assemblies in some casks when loading more recently-discharged fuel to maintain overall heat load limits). A report prepared by NAC International entitled, “NAC White Paper on Establishing a Balanced Perspective on Wet and Dry Storage of Used Fuel at U.S. Reactors,” dated July 7, 2011, makes similar arguments with respect to the impacts of expediting fuel movement (NAC, 2011).

The updated EPRI study, EPRI TR-1025206 (EPRI, 2012), revised the 2010 study to evaluate the dose and cost impacts of accelerating transfer of spent fuel considering two scenarios – one where the campaign takes 10 years and one where it takes 15 years. The report also adds estimates of the reduction in Cs-134 and Cs-137 inventories in the SFP due to accelerated transfer of spent fuel. The updated report estimates the worker doses to be much higher than the 2010 study projected (3 to 4 times higher), while the costs are roughly equivalent. The

reduction in Cs-134 and Cs-137 inventories reported range from 43% to 53%. None of the industry studies attempt to calculate offsite consequences associated with postulated SFP accidents, which is a significant difference between those studies and the study documented in this report.

Regarding the amount of fuel older than five years, and its associated decay heat, the table below compares industry averages reported in the NAC study with those from the study presented in this report.

**Table 2 Comparison of Fuel Age and Heat Load against Industry Averages**

Time since discharge (yrs.)	Mass as a % of all fuel		Heat generation as a % of all fuel	
	Industry average	This study	Industry average	This study
< 5	22%	18%	58%	58-90%
5-9	22%	27%	22%	6-22%
10-14	16%	18%	9%	2-8%
15-19	15%	19%	6%	1-7%
20-24	10%	17%	3%	1-4%
25-29	6%	1%	1%	0-1%
30-34	4%	-	<1%	-
Remainder	4%	-	<1%	-

The NAC white paper and the latter (2012) EPRI study, make the case that heat load distributions like the ones in Table 2 support the notion that moving fuel older than 5 years has only modest effects on the overall SFP heat load (and thereby the cooling requirements and mitigative time available for beyond-design-basis SFP accidents). The values in the table for the site studied here highlight the caution that accompanies treating the heat load as a point estimate (the range of values in this study represent snapshots during the operation cycle). That said, the values from the reference plant (across the representative operating cycle) only strengthen the argument that the SFP heat load is driven by the fuel less than five years old.

## **1.8 Potential Follow-On Work and Related Activities**

It is important to recognize that there are several ongoing activities that have a peripheral relationship to this study. These include, but are not limited to, the following:

- NRC Order EA-12-049, “Issuance of Order to Modify Licenses with Regard to Requirements for Mitigation Strategies for Beyond-Design-Basis External Events” (NRC, 2012g)
- NRC Order EA-12-051, “Issuance of Order to Modify Licenses with Regard to Reliable Spent Fuel Pool Instrumentation” (NRC, 2012h)
- 10 CFR 50.54 (f) letters to licensees to review seismic hazards (NTTF Recommendation 2.1)
- 10 CFR 50.54 (f) letters to licensees to review onsite shift minimum staffing levels for emergency response and performance of mitigating strategies in accordance with Order EA-12-049 (NTTF Recommendation 9.3)

- SECY 12-0095, Recommendation AR 5 "Expedited Transfer of Spent Fuel from Spent Fuel Pools to Dry Storage"
- an ongoing rulemaking related to security requirements for ISFSIs
- reevaluation of the role of defense-in-depth in regulatory decision-making
- reconsideration of the use of land contamination and economic consequences in the context of regulatory decision-making
- assessment of the effects of seismic events and accident conditions on neutron absorber materials used in SFPs
- performance of a site Level 3 PRA for Vogtle Units #1 and #2 (operating PWRs), including consideration of both wet and dry storage per SECY-11-0089.

Other aspects of SFP risk that have not been informed by this or past studies, may be addressed by future studies, such as the site Level 3 probabilistic risk assessment (PRA), as documented in SECY-11-0089, "Options for Proceeding with Future Level 3 Probabilistic Risk Assessment Activities," dated July 7, 2011, and the associated staff requirements memorandum; or will be addressed through other inputs to the regulatory decision-making process, as needed.

## **1.9 Layout of Remainder of This Report**

The remaining sections of this report provide the following information:

- major assumptions and limitations
- seismic hazard characterization
- structural analysis methods and results
- scenario delineation and probabilistic considerations
- accident progression analysis methods and results
- offsite consequence analysis methods and results
- human reliability analysis
- sensitivity studies to investigate selected assumptions
- comparison of results with past wet and dry storage consequence and risk studies
- summary of backfitting screen analysis

Finally, Appendix A provides details on the emergency response models, Appendix B provides a gap analysis related to the larger question of assessing the impacts of expedited fuel movement, Appendix C provides study-related correspondence with the US NRC's Advisory Committee on Reactor Safeguards (ACRS) and Appendix D provides a regulatory analysis for expedited transfer at the reference plant.



## 2. MAJOR ASSUMPTIONS

### 2.1 Study Assumptions

Assumptions made during the conduct of this study are documented throughout this report. For reader convenience, major assumptions are catalogued in Table 3.

**Table 3 Major Assumptions**

<b>Topical Area</b>	<b>Major Assumption</b>	<b>Comment</b>
Overall Approach	A <b>BWR Mark I</b> with a non-shared SFP is studied.	This plant was chosen for a mix of reasons, including availability of computer models, and a perception of greater external stakeholder interest in elevated (relative to grade) SFPs combined with the fact that the nuclear reactors that felt the higher tsunami waves and stronger ground motions from the March 11, 2011 Tohoku earthquake, which includes those at the Fukushima Daiichi nuclear power plant, were all BWR reactors. Its selection does not denote a belief that this type of design is more vulnerable.
	The <b>beyond design basis earthquake</b> is assumed to occur. This is an unlikely event.	The earthquake studied has an estimated frequency of occurrence of one time in 60,000 years. The likelihood of the event is included in the reporting of frequency-weighted consequences.
	The <b>reliability of mitigation</b> is not included in the likelihood estimates provided in Chapter 5 through Chapter 7.	The accident progression and consequence analyses were originally conducted without the benefit of a human reliability analysis. The results were then used to frame a human reliability analysis, which is provided in Chapter 8.
	<b>Multi-unit / concurrent reactor accidents</b> are not, in general, considered.	Specifically, the reactor (and its decay heat) is treated during the outage until the level in the reactor well / SFP drops to below the bottom of the fuel transfer canal. Beyond that point, and in all portions of the post-outage scenarios, the reactor is not considered as a source of steam, fission products or hydrogen. The human reliability analysis presented in Chapter 8 does consider multi-unit effects, and Sections 9.3 and 2.2 further discuss this assumption.
	This study represents a limited-scope <b>consequence study</b> as opposed to a probabilistic risk assessment.	This approach focuses resources on a particular scenario of interest and places greater emphasis on modeling fidelity for that scenario, but also limits the potential end-uses of the study. See Section 1.5 for more information on this assumption.
	<b>Multi-unit aspects</b> are only considered for certain aspects of the study.	See Section 2.2 for more information on this assumption.

Topical Area	Major Assumption	Comment
	<b>Inadvertent criticality</b> events are not considered.	See Section 2.3 for more information on this assumption.
	<b>Other considerations</b> associated with expedited fuel movement.	See APPENDIX B: for a qualitative consideration of fuel movement and APPENDIX D: for quantitative considerations.
Seismic Hazard Characterization	<b>Vertical PGA</b> equal to the horizontal PGA and vertical spectral accelerations equal to the horizontal spectral accelerations	A few studies (e.g., McGuire, Silva, and Costantino, 2001; ASCE, 1999) indicate that for rock sites and frequencies near and above 10 Hz, and especially nearby seismic sources, vertical spectral accelerations may be as high as or exceed horizontal spectral accelerations. For this study, the frequencies of interest are, for the most part, frequencies near or above 10 Hz. Therefore, the assumption of equal vertical and horizontal spectral accelerations was deemed to be a reasonable starting assumption. This assumption is also supported by seismic hazard de-aggregation with the USGS 2008 model which indicates that for the seismic bins of interest (high PGA, low likelihood hazard) the contributors to the hazard would be earthquakes with magnitudes less than 6 at about 20 km from the site.
	<b>Seismic hazard models</b> - this study used the existing USGS 2008 model instead of the model in the ongoing program.	A new probabilistic seismic hazard model is currently being developed and will consist of two parts: (1) a seismic source zone characterization and (2) a ground motion prediction equation (GMPE) model. Although part (1) is now complete (NRC, 2012b), it was not available at the start of this scoping study. In addition, the GMPE update is still in progress. Furthermore, the NRC is currently developing an independent probabilistic seismic hazard assessment (PSHA) computer code to incorporate part (1) and part (2) when complete. While the USGS (2008) hazard model is not sufficiently detailed for regulatory decisions, it is appropriate to use for this study because it was the most recent and readily available hazard model for the selected site at the start of the study.

Topical Area	Major Assumption	Comment
Structural and Related Initial Damage State Characterization	<p><b>In-structure response spectra (ISRS)</b> for the study are obtained by scaling ISRS developed for the seismic PRA for PBAPS for the NUREG-1150 study.</p>	<p>Given the differences in the ground motions for the NUREG-1150 PRA and for this study, the use of this scaling is likely to be at or somewhat past the limit of acceptability. The scaling was nevertheless used because it is consistent with the practice of expedited studies of risk or margin. In addition, the assumption (and the uncertainties that it introduces) were deemed to be consistent with the uncertainties in other approximations used in the structural and seismic assessments for the study.</p>
	<p>A <b>static nonlinear pushover analysis</b> is used to estimate the overall response of the SFP, concrete strains and cracking, and related liner strains. This analysis used equivalent seismic forces, including hydrodynamic forces, based on elastic ISRS.</p>	<p>As the structure cracks and behaves in a nonlinear manner, it becomes sensitive to frequencies less than its elastic frequencies and dissipates energy, especially if the structure can respond in a non-brittle failure mode. For the ground motions considered in this study, lower frequencies of vibration tends to correspond to lower loads on the structure because spectral accelerations also decrease as the frequencies of vibration decrease. The approach used is, therefore, thought to be conservative for the frequency content of the ground motion expected at the site. Some of this conservatism was accounted for, in part, by: (i) considering a higher damping ratio for the SFP/Reactor-building system (10-percent) than that used for the design basis loads, (ii) calculating equivalent loads using a reduced concrete stiffness, and (iii) by considering a small range of reduction for the calculated liner strains that also accounts for possible ground motion incoherency. A preferred approach to account for this conservatism and also ground motion incoherency effects would involve the sampling of representative ground motion time-histories, both vertical and horizontal, and their use in time-history analyses of the coupled reactor building and SFP structures. This approach, ideally also modeling the small embedment of the reactor building using soil-structure interaction analysis, would more rigorously account for the anticipated conservatisms referred to above but was deemed to be outside the scope of the study.</p>
	<p>Aftershocks are not likely to induce subsequent additional damage to the SFP</p>	<p>The main event would crack the SFP in this study, however it is expected that the SFP's structure would remain stable after the earthquake and resistant to additional loading cycles at this level.</p>

Topical Area	Major Assumption	Comment
	No significant debris generated by the seismic event enters the SFP.	Based on the expected structural response of the building, overhead crane, etc. there is no expectation that heavy debris that would damage the pool and fuel will be generated as a direct result of the seismic event itself.
	The seals of the refueling gate do not fail.	Finite element analysis does not predict large deformations in this area that would suggest such an event is likely. Details of the gates provided by the licensee show that there are two gates with a gap in between and that each gate has mechanical seals to prevent leakage. These seals are kept under pressure by passive mechanical means (i.e., do not depend on air pressure, ac power, or dc power) that are unlikely to fail under the earthquake.
	Failure of nearby dams is not explicitly addressed.	The Conowingo Dam is located approximately 9 miles downstream of the site. Failure of that dam could not flood the site. It could lead to additional complications for accident management strategies relying on the river as a water source. The Holtwood Dam is located approximately 6 miles upstream of the site. Failure of this dam, or partial failure in combination with the probable maximum flood, is considered in the plant's Updated Final Safety Analysis Report (UFSAR), in Section 2.4.3.5. Based on the UFSAR, should a complete failure in the upstream dam take place, the rise in the Conowingo Pond level at the site is not expected to exceed grade level, since the pond is about 1 mi wide at the site and the water level would be relieved by the downstream dam.
Scenario Delineation and Probabilistic Treatment	<b>Offloading of older fuel in to casks</b> (as part of the normal fuel management practices as opposed to an expedited fuel movement program) is not explicitly treated.	This assumption is not expected to have a significant effect on the results. See Section 5.2 for more information.

Topical Area	Major Assumption	Comment
	A <b>full core offload</b> is not treated (except as discussed to the right) as either part of the routine refueling or in the context of an emergent need to defuel the reactor later in the operating cycle (e.g., due to a forced shutdown that requires accessing the lower internals of the reactor vessel).	In reality, the full core's decay heat is considered during the outage, in that the reactor and SFP are hydraulically connected, and all fuel contributing to pool heatup is considered (along with the larger volume of water) until the point that water level drops below the fuel transfer canal (and the reactor well and SFP become hydraulically disconnected). That being said, radiological release from the fuel remaining in the reactor is not considered, since the simulation focuses only on the SFP once the reactor well and SFP have become hydraulically disconnected. The rationale for choosing a "core shuffle" rather than a full core offload is because the former is the typical case for BWRs. Emergent core offloads later in the operating cycle are not typical, and thus are not treated.
	<b>New fuel</b> temporarily stored in the spent fuel pool is not treated.	This fuel would be placed in the spent fuel pool just prior to the outage (the subject plant does not use a separate new fuel vault). Thus, the fuel would only be present for a very short portion of the operating cycle. During the time that the new fuel is in the SFP, it would affect the amount of zirconium present to participate in a propagating zirconium fire, but would have a negligible effect on the source term. See Section 5.2 for additional information.
	Use of a <b>1x4 pattern</b> , rather than the 1x8 pattern currently in use at PBAPS.	The 1x8 pattern currently in use at PBAPS is believed to be atypical and is not required by regulation. The timing of obtaining the actual pool configuration, along with modeling conveniences associated with how the MELCOR SFP model is currently designed, also played a role in the decision to use the 1x4 pattern. In cases where the use of a 1x8 pattern might affect study conclusions, this is identified, and Section 9.2 investigates this assumption.
	For the low-density loading situation, the <b>high-density racking</b> will be used as opposed to low-density racking.	Re-racking the pool would represent a significant expense, along with additional worker dose, and was not felt to be the likely regulatory approach taken based on consultation with the Office of Nuclear Reactor Regulation. Much of the benefit of low-density racking is achieved by the implementation of a favorable fuel pattern (1x4). Additionally, to get the full benefit of low-density racking, BWR fuel would likely need to have the channel boxes removed.
	Effects on results if a <b>contiguous storage pattern</b> were used during the outage.	See Section 9.3 for more information on this assumption.

Topical Area	Major Assumption	Comment
	An assembly in the <b>lifted position</b> (i.e., in the process of being moved) at the time of the seismic event is not treated.	The current tools do not allow for explicit treatment of this situation. Such a situation could lead to accessibility issues (which are already treated via the scenarios without 50.54(hh)(2) equipment), but could also lead to a small earlier release for some situations. Note that Section 5.4 does include information about dose rates on the refuel floor associated with uncovering a single assembly in the lifted position.
	50.54(hh)(2) <b>mitigation capacities</b> (i.e., 500 gpm makeup delivered or 200 gpm spray delivered) are based on the generic NRC-endorsed capacities in NEI-06-12, Revision 2.	For PBAPS, the capacities of the available equipment are somewhat higher. The use of 500 and 200 gpm here attempts to account for uncertainties in the speed at which the pumps would actually be run, as well as spray that goes outside the boundary of the pool
	<b>Mode of mitigation deployment</b> (i.e., use of makeup versus spray)	For OCP 1 and OCP 2 with the “moderate” leakage condition, makeup is deployed. Other, equally reasonable assumptions about mitigation deployment could result in the deployment of sprays instead (which have a potential advantage in terms of mitigation for these conditions). This difference in mode of deployment shows the potential benefit of the additional instrumentation required by NRC Order EA-12-051. A sensitivity study related to this assumption is presented in Section 9.3, for a uniform pattern.
	Use of ac power fragility as a surrogate for <b>loss of normal SFP cooling</b> and makeup availability	This study used the ac power fragility from NUREG-1150 of 0.84 as a surrogate for the conditional probability of normal SFP cooling and makeup not being available. This simplifying assumption was made in light of the fact that the study is not a PRA (but rather a consequence analysis with probabilistic considerations) and that this value already approximates the upper bound of 1. In reality, the availability of normal SFP cooling and makeup would be a combination of the AC fragility, the fragility of the actual equipment and its support equipment, and operator actions to recover the equipment, which could result in a conditional probability higher than the value used here.

Topical Area	Major Assumption	Comment
Accident Progression Analysis	The study uses best-estimate <b>ruthenium release rates</b> calculated by the MELCOR code. These release rates are most similar to the low ruthenium release case from NUREG-1738.	This is the best estimate for actual releases based on the current state of knowledge in this area. Past studies for which this was a concern (namely NUREG-1738) used assumed source terms spanning a very large range of uncertainty rather than mechanistic and integrated modeling. Section 6.1.5 of this report provides additional information.
	<b>Radionuclide releases</b> occur only if the fuel has become uncovered by 48 hours and the radiological release has commenced before 72 hours. Otherwise, the study assumes the scenario results in no offsite consequences.	In the event of a prolonged severe accident, radiation and other hazards could make any truncation of an ongoing SFP release challenging. On the other hand, many resources are available at the State, regional, and national level that could be available to mitigate an accident. Considering both viewpoints on this issue, the project staff judged 72 hours to be a reasonable time truncation. The use of a time truncation is a point of uncertainty that can significantly affect the results. See Section 5 of the report for additional discussion on mitigation assumptions in this study and Section 9.8 for time truncation sensitivity.
	The study does not consider <b>debris</b> entering the pool as a result of any modeled <b>hydrogen combustion event</b> .	Such debris could be generated and could fall into the pool. However, the occurrence of a hydrogen combustion event in this study denotes that the fuel in the SFP has already become uncovered and is undergoing a fission product release. Thus, debris would primarily serve to inhibit longer term recovery actions not considered in this study. The occurrence of a hydrogen combustion event from a concurrent reactor accident has the potential to generate debris which could impair SFP natural circulation air or steam cooling (should the fuel in the SFP become uncovered) for conditions in which the fuel might otherwise be cooled by means of these passive cooling modes. However, this latter situation is inherently tied to the study's lack of a comprehensive treatment of multiunit aspects.
	<b>Aerosol resuspension</b> inside the reactor building, such as from hydrogen deflagration, will not be significant.	Hydrogen burns in the refueling bay are predicted to occur about the time of fuel gap release and well before significant amounts of radioactive aerosols may settle on the floor.

Topical Area	Major Assumption	Comment
	The study does not consider the effects of <b>molten core-concrete interaction (MCCI)</b> .	The MELCOR code models heat transfer from the debris to the pool floor, as well as the fission product release from hot debris. In some cases, the debris temperature remains above typical concrete ablation temperatures (~1500 K). MCCI may occur in selected scenarios in which the fuel relocated to the bottom of the pool following the failure of the rack baseplate and its temperature exceeded the concrete ablation temperature. These cases involve large-scale debris relocation and large releases of volatile fission products. Even without MCCI, the fuel in debris form continues to release fission products resulting in very large releases of volatiles. Section 9.5 of this report presents a sensitivity calculation.
	The effective time dependent <b>decontamination factor (DF)</b> of the reactor building can be used to reasonably estimate a cumulative release.	The use of an effective DF is based on a new methodology (see Section 6.1.5 of the report) for SFPs in an effort to account for a spatial distribution of the inventory and to more accurately account for the magnitude of the release based on the radionuclide, and not just the chemical group, to allow the offsite consequence code to process the source term.
	Criteria for <b>release of radionuclides in the fuel cladding gap</b>	MELCOR does not have a fuel cladding deformation and strain model. It uses a value of 900°C for widespread cladding failure. NUREG-1738 cites a temperature range of 700–850°C for rod ballooning and burst; however, the security assessment work mentioned in Section 1.7 showed that rod ballooning has a low impact on the timing to breakaway oxidation and the impact on the peak cladding temperature response was relatively insignificant. In addition, NUREG-1738 assumes 900°C as the temperature at which the onset of significant fission product release is expected. In general, there may be some fuel cladding failures at lower temperatures but MELCOR is mostly concerned with larger thermal release from the fuel. In this sense, the gap release temperature of 900°C is taken as a surrogate for start of rapid fuel heat up associated with breakaway oxidation and initiation of zirconium fire and its propagation.
Offsite Consequence Analysis	Calculated results are from <b>atmospheric-type releases</b> only	Atmospheric releases are the primary scope of the project.



Topical Area	Major Assumption	Comment
	A straight-line <b>Gaussian plume</b> segment dispersion model is used for the atmospheric transport	The current model is a straight-line transport of plume segments; therefore, it does not capture the effects from changes in wind direction after the plume segment has been released. Despite this, the atmospheric transport model in MACCS2 has compared favorably to Lagrangian particle tracking models [NRC 2004]. This is because the use of ensemble averages of many meteorological conditions, such as the consequences reported in this study, has been shown to make reliable weather-averaged results.
	<b>Distance truncation</b> (from point of release)	Health effect risk estimates (e.g. latent cancer fatality risk and early fatality risk) are with respect to distance. The reported latent cancer fatality risk includes all distances that have doses above the modeled dose limit for habitability, as determined by the Pennsylvania Code Title 25 § 219.51. Total health effect estimates are not a function of distance, and have no distance truncation.
	The effect of <b>low dose radiation</b> on latent cancer fatalities is uncertain, and therefore a range of dose truncations are reported.	See Section 7.1.3 for more information on this assumption.
	The <b>public</b> will behave in an orderly fashion during a severe accident, and can be represented by cohorts.	See Section 7.1.4 more information on this assumption.
	The seismic event has a limited effect on <b>emergency response</b> .	The study assumed that the seismic event would not significantly affect emergency response. This is based on an assessment in NUREG-1935 of the same site and seismic event that assumed the damage to local infrastructure is limited to 12 bridges, partly due to the few large structures in the area. Also, the extended loss of ac power is assumed to be limited to the EPZ (~10 miles) due to the assumption that the strength of the seismic event is from the proximity of the seismic event to the site, rather than being a wider impact from a larger magnitude. See section 7.1.4 for more details.

Topical Area	Major Assumption	Comment
	<b>Decontamination</b> will occur only if it will eventually allow for the return of land to habitability, and if it is economic to do so.	<p>A long-term cleanup policy for severe accidents does not currently exist, although guidance is currently being drafted. In addition, guidance could recommend the development of localized cleanup goals after an accident, to account for sociopolitical, technical, and economic considerations.</p> <p>Given that a policy for long-term cleanup does not currently exist (and because a developed policy may not contain explicit cleanup goals), the project instead uses dose levels associated with habitability to decide what land is to be decontaminated. This is consistent with previous studies. See Section 7.1.5 for more information on this assumption.</p>
	A single value for <b>habitability</b> is used for all affected areas.	See Section 7.1.5 for more information on decisions regarding land interdiction and associated relocation of the public.

## 2.2 Multi-Unit Considerations

### Observations Regarding a Concurrent Reactor Event:

There are four broad interplays that can be defined between the SFP and the reactor:

- (1) an initiating event that directly affects both the reactor and the SFP
- (2) a reactor accident that prevents accessibility to the SFP for a prolonged period of time (e.g., due to high radiation fields), leading to a SFP accident
- (3) a reactor accident that includes ex-containment energetic events (e.g., a hydrogen combustion event) or other ex-containment interplays (e.g., steaming through the drywell head that affects refuel floor combustible gas mixtures) and creates a hazard to the SFP (e.g., by causing debris to fall in to the pool) or otherwise changes the SFP event progression<sup>5</sup>
- (4) an SFP accident that prevents accessibility to key reactor systems and components for a prolonged period of time or which creates a hazard for equipment used to cool the reactor (e.g., the flooding of low elevations of the reactor building due to a leak in the

<sup>5</sup> For instance, a hydrogen combustion event caused by a reactor accident that affects the refuel floor superstructure can lead to additional oxidation (for an otherwise oxygen-limited situation), which in turn may result in higher releases from the SFP. Note that this can also include positive effects, in the sense that steam leaking through the drywell head can serve to steam inert the refueling floor.

pool or excessive condensation from continuous boiling of SFP water), leading to a reactor accident

For each of these interplays, large seismic events and severe weather SBO events are logically the most relevant initiators, as they are the type of initiators that are most likely to initiate an accident at the reactor and SFP, while simultaneously hampering further accessibility to key areas, key systems and components, and key resources. To the extent practicable, this study has attempted to qualitatively account for some of these effects. For example, when the reactor and SFP are hydraulically connected (during refueling), the decay heat and water volumes from both sources are considered. The study also explores these effects on mitigation (Section 8), and addresses some aspects of the uncertainty associated with this treatment (Section 9). However, explicitly modeling multiunit effects was not a focus of this study, because of the existing limitations with the available computational tools. An ongoing project described in SECY-11-0089 will attempt to more rigorously address these effects in the framework of a multiunit Level 3 PRA for Vogtle Electric Generating Plant Units 1 and 2.

#### Observations Regarding a Multiunit Event:

Along with the possibility of a concurrent SFP and reactor accident, there is the possibility for a concurrent accident at the SFP of one unit with an accident at the SFP or reactor of the other unit. Again, a large seismic event or a severe weather SBO are the events that are most likely to lead to a multiunit event. In general, if accidents at both SFPs proceed in similar manners and similar timeframes, and both pools have similar inventories of spent fuel, then the resulting source term from a dual-unit event would be roughly twice the single-unit source term. In reality, this type of perfect symmetry is unlikely because the two (or more) SFPs are very unlikely to have the same total pool heat load or peak assembly heat load. (Recall that for multiunit sites, the reactors did not usually start operation at the same time and outages are intentionally staggered.) Even if this symmetry did exist, the offsite consequences would not follow a linear scaling because of a number of nonlinearities associated with that portion of the analysis. Again, capturing these effects was not a focus of this study, and future work (the SECY-11-0089 Level 3 PRA) will attempt to more rigorously treat these effects.

### **2.3 Inadvertent Criticality**

Inadvertent criticality events (ICEs) may be possible for specific combinations of conditions (e.g., during reflood of a drained pool for a region of the pool storing higher reactivity fuel assemblies where the boron poison in the rack panels has been significantly displaced as a result of the earthquake). If such an event affected a region of the pool (as opposed to only a portion of a particular assembly), and if it occurred at a point in the accident where the fuel was only partially covered, the event could have an important impact on onsite dose rates. Further, if an ICE were severe enough to produce significant heat, the fuel will be harder to cool and short-lived radionuclides will be produced. Design requirements and safety analyses ensure that the spent fuel stored in the pool, under normal conditions, will not result in a critical configuration. For the reference plant (and other U.S. SFPs), this is ensured through a combination of assembly spacing and neutron poison material (e.g., Boraflex). If a seismic event did cause reconfiguration of the fissionable material by means of either (1) direct movement of the fuel, (2) direct degradation of the poison material, or (3) indirect effect on either the fuel or poison material because of high temperatures associated with an induced accident, there are several “advantageous” considerations, including the following:

- The reactivity of fresh BWR fuel is suppressed by the high content of burnable absorbers.
- The majority of the fuel in the SFP has low net reactivity since it has gone through more than one operating cycle in the reactor.
- The fuel with the highest net reactivity will likely be the once-burned assemblies which will stay in the reactor during a “shuffling” refueling outage (but would not stay in the reactor for a full core offload).
- Critical configurations of low-enriched uranium fuel require the presence of a neutron moderator (in this case water or steam) such that an ICE would not happen in the presence of air.
- BWR SFPs do not use borated water so the fact that the SFP may be refilled with unborated water is not a deviation from the norm.
- Low-enriched uranium fuel assemblies (which are used in all U.S. reactors) are generally geometrically designed to maximize reactivity (moderator/fuel geometry) in the reactor and so any significant alteration of the geometry of a given assembly will likely be in the direction of a less criticality-prone configuration.

There are also a few counter considerations:

- The poison material in the rack panels contribute significantly to the net reactivity of the SFP configuration (i.e., they are a key component to ensuring subcriticality for high reactivity assemblies).
- The effects of large seismic events on already degraded SFP rack poison material are not easy to quantify.
- The rack panels and poison material have a lower melting temperature than the cladding and fuel.
- Termination of a SFP ICE during an event that required deployment of mitigation equipment could be difficult.
- The possibility of a criticality event cannot be summarily dismissed.

Finally, the offsite consequences of a criticality event (especially if it occurs when overlying water is present) are believed to be less severe from a public health and safety standpoint than the offsite consequences from a potential large release of radioactive material associated with a prolonged uncovering of the fuel in the SFP resulting from not attempting to reflood. In consideration of all of the above, common accident management practices in the United States call for the use of any available water in responding to fuel uncovering in either the reactor or SFP. This study shows the precedent, while recommending that future work be done to better understand the specific combinations of conditions that could lead to ICEs during a large seismic event.

## 3. SEISMIC HAZARD CHARACTERIZATION

### 3.1 Basis for Probabilistic Estimates

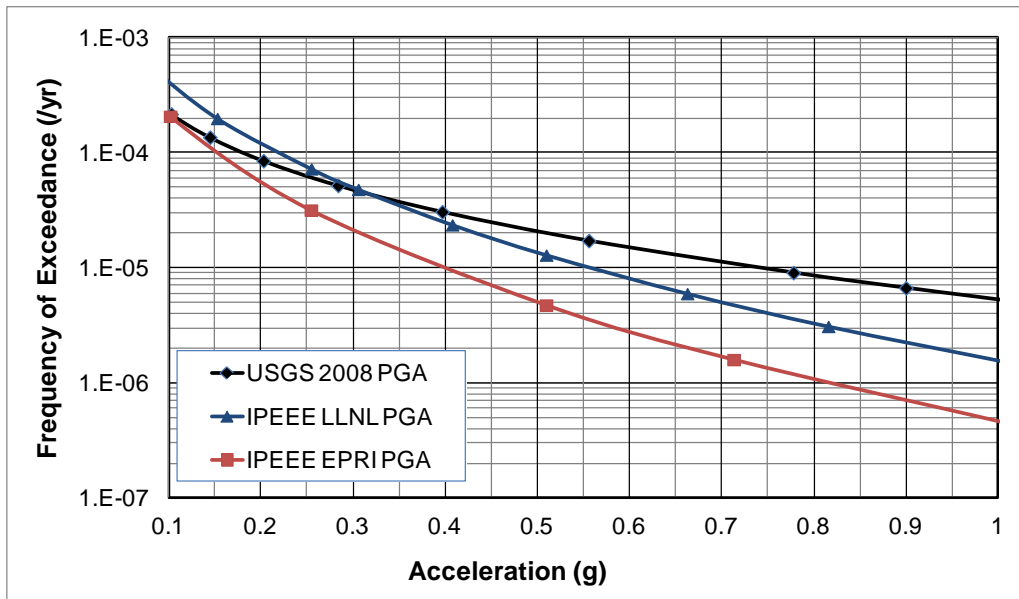
The primary sources of information for seismic hazard estimates at nuclear power plant sites include (1) the NRC/ LLNL (Bernreuter et al., 1989; Sobel, 1994) model (hereafter referred to as the LLNL model); (2) the EPRI model (Toro et al., 1989); and (3) the USGS model developed in the mid-2000s (Peterson et al., 2008) (hereafter referred to as the USGS 2008 model). The implementation of the individual plant evaluation for external events (IPEEE) program utilized both the LLNL and EPRI models (NRC, 2002b). The National Seismic Hazard Mapping Project utilized the USGS 2008 model. The NRC also utilized the USGS 2008 model for the seismic hazards estimates used in screening level assessments for Generic Issue 199 (GI-199) (NRC, 2012a).

The seismic hazard assessment in this study is the US Geological Survey (USGS, 2008) hazard model. A new probabilistic seismic hazard model is currently being developed and will consist of two parts: (1) a seismic source zone characterization and (2) a ground motion prediction equation (GMPE) model. Although part (1) is now complete (NRC, 2012b), it was not available at the start of this scoping study. In addition, the GMPE update is still in progress. Furthermore, the NRC is currently developing an independent probabilistic seismic hazard assessment (PSHA) computer code to incorporate part (1) and part (2) when complete. While the USGS (2008) hazard model is not sufficiently detailed for regulatory decisions, it is appropriate to use for this study because it was the most recent and readily available hazard model for the selected site at the start of the study.

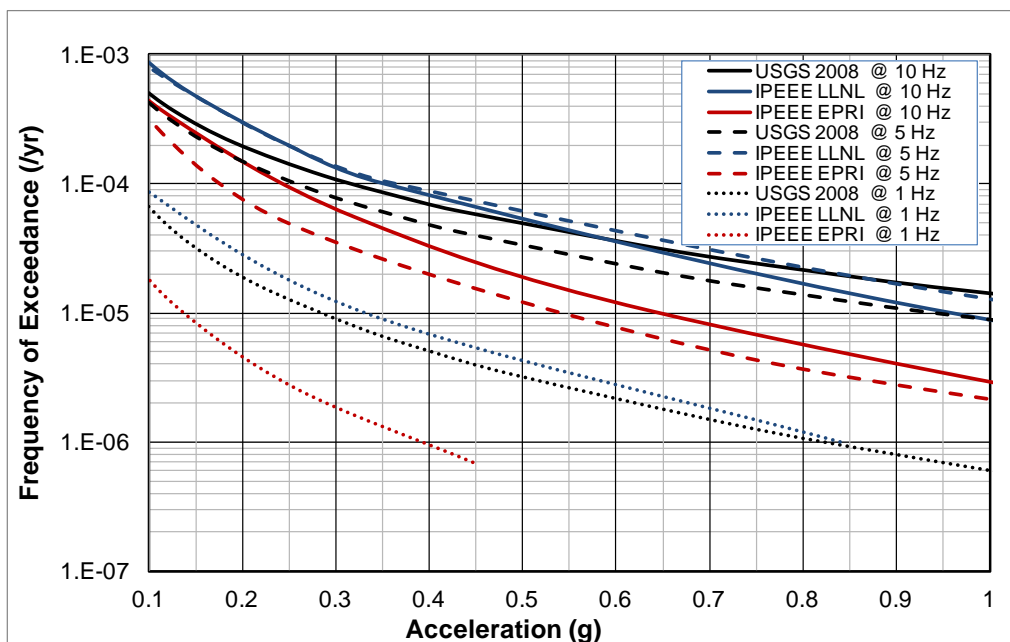
Figure 2 (PGA) and Figure 3 (1-, 5-, and 10 Hz spectral acceleration) graphically show comparisons of hazard estimates for the reference site (a rock site) with the three information sources listed above. These comparisons are provided to compare the model used in this study to well-known and extensively documented information sources (LLNL model and EPRI model) that were used in past SFP risk studies. The comparisons support the following observations:

- For the PGA, the USGS 2008 model predicts higher annual probability of occurrence for high-level, low-probability events, specifically for events with PGAs greater than about 0.35g.
- For moderate PGAs, from about 0.1g to 0.35g, the LLNL model is higher than the USGS 2008 model. For events above about 0.35g, which are lower probability events, the USGS 2008 model is higher than the LLNL model until both hazard estimates differ by factors of about 2.5 at 0.75g and about 3 at 1.0g.
- The EPRI model hazard estimates are lower than those from the USGS 2008 model for all PGAs. Specifically, hazard estimates based on the USGS 2008 model are about 2 times greater at 0.2g with the difference increasing to about 10 times at 1.0g.
- Thus, in terms of PGA, the seismic hazard estimates used for this study are about 2.5 times greater than LLNL model estimates and about 6 times greater than EPRI model estimates at 0.75g.

- Curves for the USGS 2008 model and the LLNL model are comparable for each representation, with the USGS 2008 model sometimes being higher (higher annual probability of occurrence) and the LLNL model sometimes being higher.
- Generally, the 10-Hz curve is the highest, followed by the 5-Hz curve, followed by the PGA curve, followed by the 1-Hz curve. The notable exception to this is the fact that the 5-Hz LLNL model curve, which is higher than the 10-Hz curve.

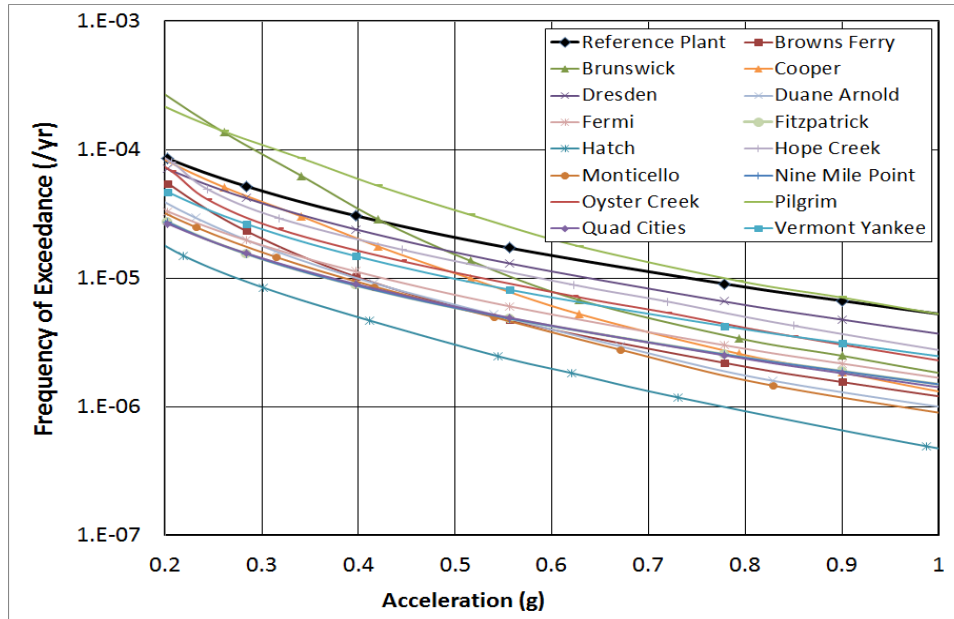


**Figure 2 Comparison of PGA exceedance frequencies at the reference plant**

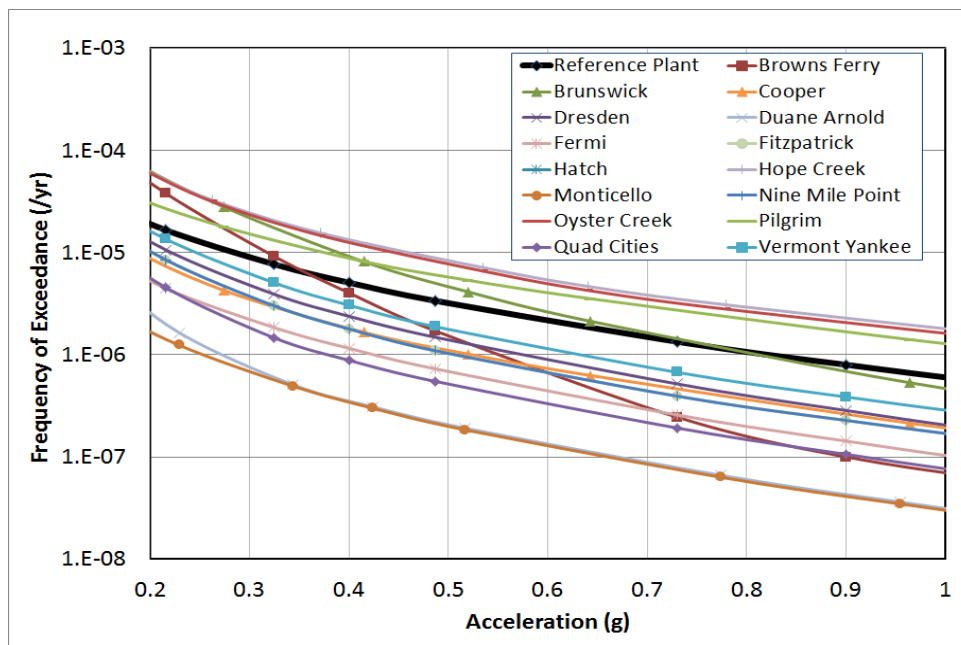


**Figure 3 Comparison of spectral exceedance frequencies at the reference plant (rock hazard curves)**

A comparison of the annual frequency of exceeding a given PGA for all Mark I sites (Figure 4) shows that the reference plant falls close to the upper end of the group in terms of hazard estimates. When comparing the annual frequency of exceeding a given 1-Hz spectral acceleration (Figure 5), the reference site is in the upper half of the group.



**Figure 4 Comparison of annual PGA exceedance frequencies for U.S. Mark I reactors (USGS 2008 model) (rock hazard curves)**



**Figure 5 Comparison of annual exceedance frequencies for 1 Hz spectral accelerations for U.S. Mark I reactors (USGS 2008 model) (rock hazard curves)**

### 3.2 Characterization of the Event Likelihood

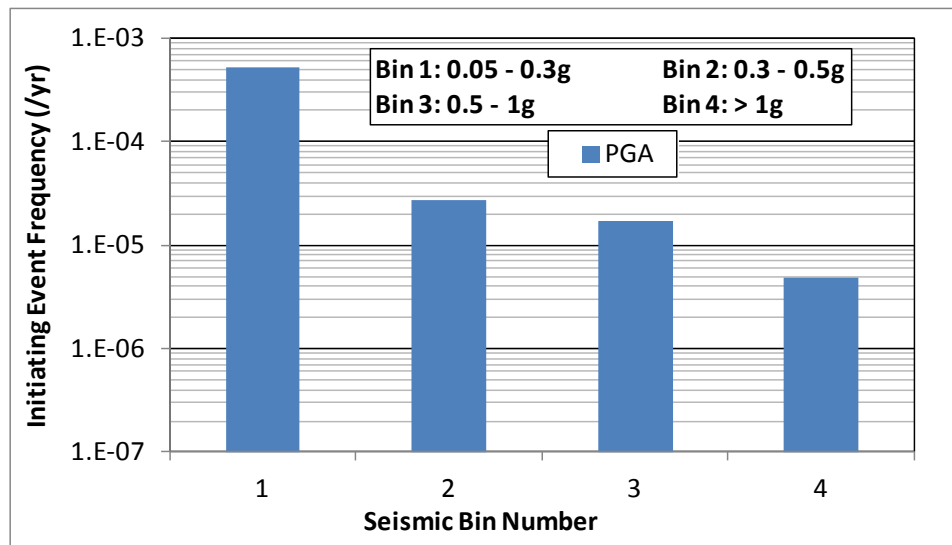
Hazard exceedance frequencies can be translated into initiating event frequencies by partitioning the PGA range into a number of discrete categories (bins) defined in terms of PGA intervals. These bins define a discrete number of seismic event scenarios with increasing intensity (PGA). Revision 1.01 of the NRC handbook entitled, "Risk Assessment of Operational Events, Volume 2—External Events," issued January 2008 (NRC, 2008b), recommends the use of at least three bins unless plant-specific considerations require more bins. The SFPS used four bins.

Table 4 shows the resulting bins, along with the tabulated frequencies for various spectral and peak accelerations. Note that for bin 4, the representative bin PGA has been set to 1.2g by convention, whereas for the other bins, it is the geometric mean of the interval endpoints. Figure 6 shows these results graphically.

**Table 4 Seismic Bins and Initiating Event Frequencies**

Bin #	Bin Range (g)	Bin PGA (g)	Approximate Initiating Event Frequency (USGS 2008 model) (/yr)
1	0.05 - 0.3	0.12	$5.2 \times 10^{-4}$
2	0.3 - 0.5	0.4	$2.7 \times 10^{-5}$
3	0.5 - 1.0	0.7	$1.7 \times 10^{-5}$
4	> 1.0	1.2 <sup>†</sup>	$4.9 \times 10^{-6}$

<sup>†</sup> Assumed based on PRA modeling convention



**Figure 6 Comparison of seismic initiating event frequencies**

Based on this information, and on a review of the results of past studies which indicate that damage to the SFP and other relevant structures, systems, and components (SSCs) is not credible for events in bins 1 and 2, this study focused on bin 3. The project staff concluded that seismic bin 3 provides the best compromise between events with higher occurrence frequencies that would lead to little or no damage versus higher consequence events with very low frequencies. Review of past studies (e.g., NUREG-1738 (NRC, 2001)) indicates that events in



bin 3, with initiating annual frequencies on the order of  $1 \times 10^{-5}$  to  $2 \times 10^{-5}$ , could challenge the integrity of the SFP (i.e., of causing a leak) at the reference plant. Thus, this is the initiating earthquake chosen for this study. It is an event that is no more severe than events considered in past reactor and SFP PRAs and consequence studies.

This study therefore considers a challenging, but very low probability earthquake as the initiating event, selected based on the considerations indicated above. This decision translates into a seismic event with a PGA several times greater than that associated with the design-basis earthquake, currently called the safe-shutdown earthquake or SSE. The PGA for the reference plant SSE is 0.12g. (This is about a magnitude 5.3 earthquake at about 25 kilometers (km).) While the probability of occurrence of this earthquake was not used in its selection, the annual probability of occurrence for this PGA is about  $1.8 \times 10^{-4}$  (approximately one event in 5,500 years) when calculated using the EPRI and USGS 2008 models and about  $3.2 \times 10^{-4}$  (approximately one event in 3,200 years) when calculated using the LLNL model. An initial determination, largely based on the results of past studies (NRC, 2001; Prassinis et al., 1989) and engineering judgment, was that the ground motions associated with the SSE (bin 1) would not be large enough to damage the SFP at the reference plant.

The information above coupled with the review of previous studies (NRC, 2001) suggests that the frequency of a seismic event that could challenge the integrity of the SFP at the reference plant is on the order of  $1.7 \times 10^{-5}$  per year (i.e., approximately one event in 60,000 years) or less. Table 5 contrasts this frequency against other sources of information. The Mineral, VA, earthquake of August 23, 2011, which occurred near the North Anna nuclear power plant, can serve as a point of reference. In that case, the NRC staff concluded, using data from USGS instruments, that the PGA at the North Anna site was about 0.26g (NRC, 2011b). Using the USGS 2008 information for North Anna, the hazard frequency for an event with this PGA is about  $1.2 \times 10^{-4}$  per year (one event every 8,300 years). This frequency places the Mineral, VA, event in bin 1.

**Table 5 Comparison of Seismic Frequencies from Various Sources**

Source	Estimated initiating event frequency of a large seismic event <sup>1</sup>	Notes
USGS 2008	$1.7 \times 10^{-5}$ /yr (one event in 60,000 years)	Frequency of seismic bin 3 of 4 (0.5 to 1g)
The reference plant's SPAR-EE Model (v3.21, Rev. 1)	$1.3 \times 10^{-5}$ /yr (one event in 77,000 years)	Frequency of seismic bin 3 of 3 (> 0.5g)
NUREG-1738 <sup>1</sup>	$1.1 \times 10^{-5}$ /yr (one event in 90,000 years)	Frequency of seismic hazard between 0.51g to 1.02g

<sup>1</sup> Initiating event frequencies reported are those based on the LLNL models (Sobel, 1994).

In addition to the PGA, ground motions at a site are also characterized by their frequency content expressed in terms of response spectra. Section 3.3 describes the procedure used to develop the horizontal and vertical acceleration response spectra for the input ground motion for this study.

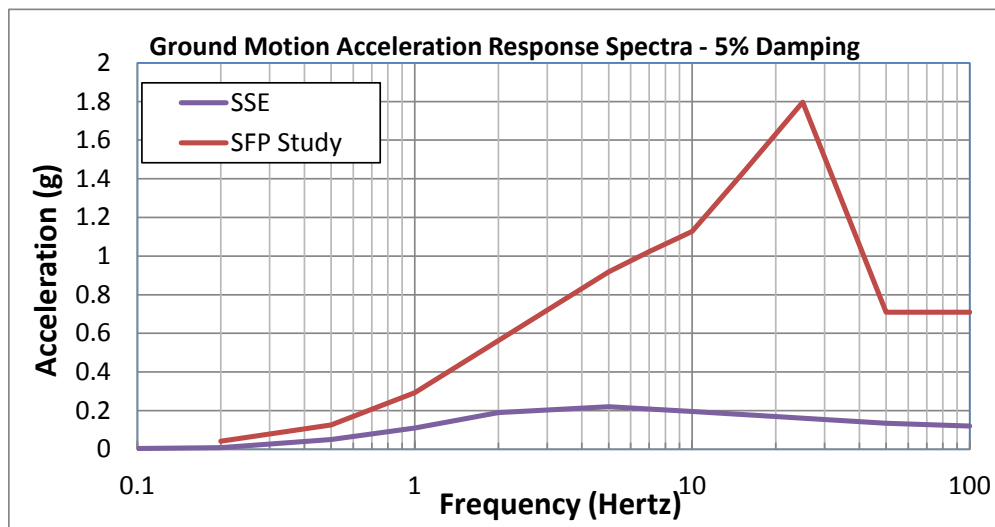
Other response spectra of interest for this study are (1) the plant's SSE response spectra and (2) the free-field response spectra used in the seismic PRA for the NUREG-1150 study. These spectra are of interest for comparison purposes. The spectra in the NUREG-1150 study are also of interest because in-structure response spectra calculated for those ground motions were

scaled (see Section 4), in approximation, to estimate in-structure response spectra for the input free-field ground motion used in this study. Volume 1, Part 3, of NUREG/CR-4550, “Analysis of Core Damage Frequency: Peach Bottom, Unit 2 External Events,” issued December 1990 (Lambright et al., 1990), provides the horizontal and vertical free-field response spectrum used in the NUREG-1150 seismic PRA for Peach Bottom in terms of the median spectral ordinates for various values of the PGA. As shown in Section 3.3, the spectral shape for this study differs from the SSE response spectrum, as well as from the median response spectra considered in the NUREG-1150 seismic PRA. Frequency content for the SSE and the NUREG-1150 PRA spectra generally resemble each other.

### 3.3 Characterization of the Ground Motion Response Spectra

Spectral shapes developed for the safety/risk assessment results for the GI-199, which utilized the USGS (2008) model, were used to develop the free-field acceleration response spectra for this study. The free-field acceleration response spectrum developed for the GI-199 for this site has a zero-period spectral acceleration (PGA) of about 0.34g. The acceleration response spectra for the free-field ground motion for the initiating seismic event considered for this study (bin 3 in Table 4 and a PGA of 0.7 g) were derived from the GI-199 spectra shape as follows:

- Horizontal shaking: horizontal response spectrum is the GI-199 spectral shape scaled to the bin 3 PGA (zero-period acceleration) of about 0.7g (specifically 0.71g). While it is recognized that the frequency content of ground motions may change somewhat with increasing PGA levels, scaling of the spectral shape for the 0.34g PGA to the bin 3 PGA is considered a reasonable approximation for low probability hazard for this rock site and for the purposes of this study. Figure 7 compares the horizontal input acceleration response spectra for this study to the horizontal response spectrum for the plant’s Safe Shutdown Earthquake (SSE) (PGA of 0.12g) for 5-percent damping.



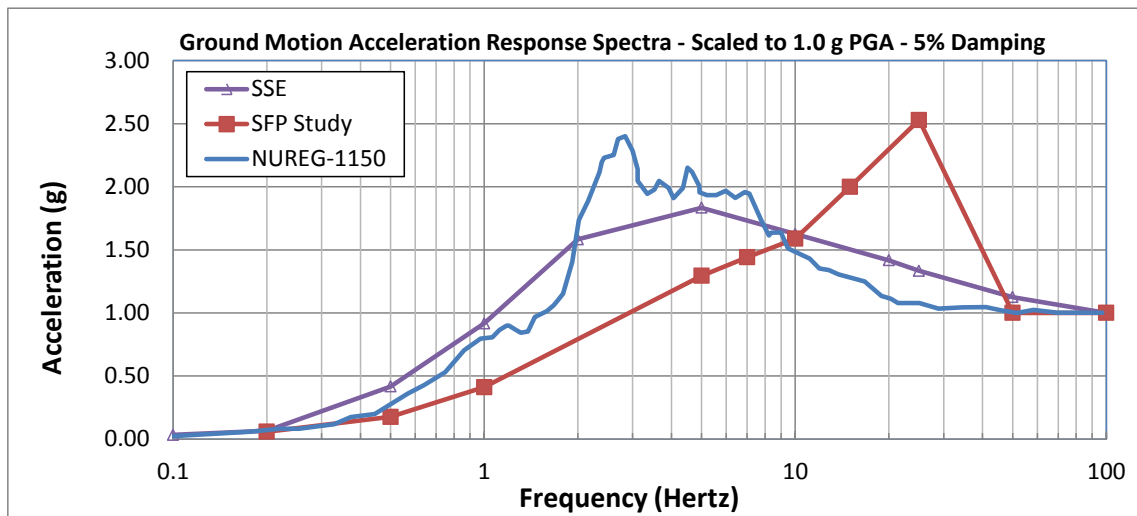
**Figure 7 Input acceleration response spectrum and SSE (Horizontal Ground Motion)**

- Vertical shaking: vertical spectral accelerations and the vertical PGA (0.7 g) are assumed to be the same as the horizontal spectral accelerations and PGA. A few studies (e.g., McGuire, Silva, and Costantino, 2001; ASCE, 1999) indicate that for rock sites and frequencies near and above 10 Hz, and especially nearby seismic sources,

vertical spectral accelerations may be as high as or exceed horizontal spectral accelerations. For this study, the frequencies of interest are, for the most part, frequencies near or above 10 Hz. Therefore, the assumption of equal vertical and horizontal spectral accelerations was deemed to be a reasonable starting assumption. This assumption is also supported by seismic hazard de-aggregation with the USGS 2008 model which indicates that for the seismic bins of interest (high PGA, low likelihood events) the contributors to the hazard would be earthquakes with magnitudes less than 6 at about 20 km from the site.

Other response spectra of interest for this study are the free-field response spectra used in the seismic PRA for the NUREG-1150 study (Lambright et al., 1990). These spectra are of interest because in-structure response spectra calculated for that ground motion were scaled, in approximation, to estimate in-structure response spectra for the free-field ground motion considered for this study. Figure 8 compares the frequency content of the horizontal response spectra (5-percent damping) for the SSE, the median response spectrum used in the NUREG-1150 study, and the spectral shape used in Spent Fuel Pool Study. For this comparison, all spectra are scaled to a PGA of 1.0g. When the three response spectra under consideration are scaled to the same PGA, the information in Figure 8 supports the following observations:

- For frequencies between about 10 Hz and 45 Hz, the spectral shape used in this study has higher spectral accelerations than the ground shaking considered for the SSE and for the NUREG-1150 study.
- For frequencies between about 0.5 Hz and 10 Hz, which is generally the frequency range most damaging for nuclear power plant structures, the spectral shape used in this study has lower spectral accelerations than the ground shaking considered for the SSE and the NUREG-1150 study.



**Figure 8 Response spectrum for 5-percent damping scaled to 1.0 g PGA: SSE, NUREG/CR-4550 (NUREG-1150 PRA), and this study (GI-199)**

As noted above, the input horizontal acceleration response spectrum for the event considered in this study is the spectral shape derived for the GI-199 study using the USGS 2008 model (PGA of about 0.34g) scaled to a PGA of about 0.7g. Figure 9 shows the horizontal response spectra (5-percent damping) for the event considered in this study, for the SSE (0.12g PGA), and for the

response spectrum used in the NUREG-1150 PRA. The NUREG-1150 response spectra shown in the figure is scaled from a PGA of 0.3g to the PGA of the event for this study. Figure 10 illustrates how the ground motions considered in this study are considerably more challenging than those for the SSE. However, these ground motions are also significantly less likely as indicated in Table 4. They are also richer at the high frequencies (greater than 10 Hz), which generally tend to be less challenging to nuclear power plant structures.

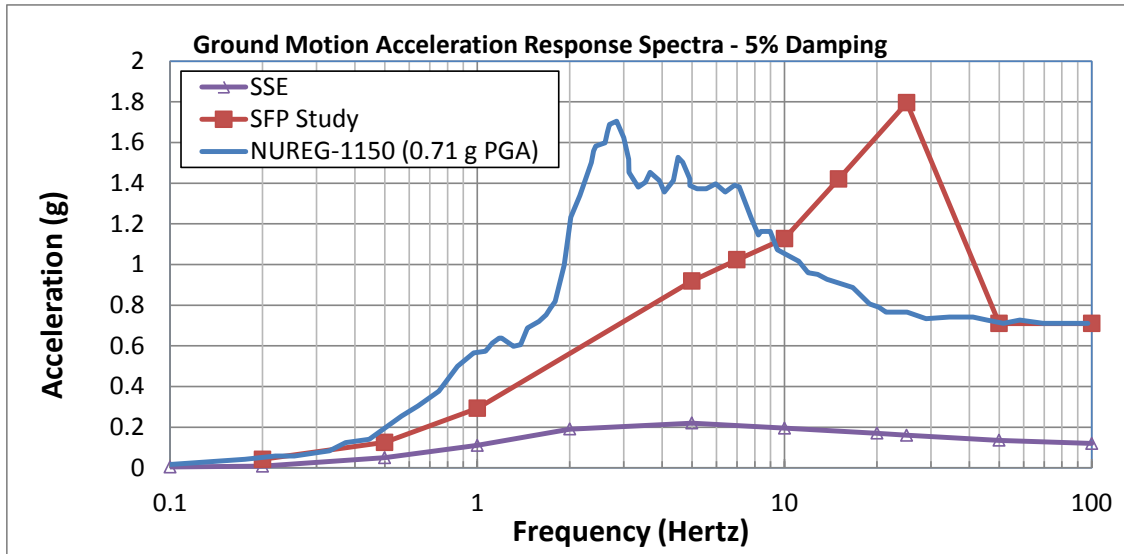


Figure 9 Horizontal response spectrum (5-percent damping): SSE, SFP Study and NUREG-1150 PRA (for 0.71g PGA)

## 4. STRUCTURAL ANALYSIS AND RELATED INITIAL DAMAGE CHARACTERIZATION

This section documents the structural analysis performed to estimate the initial damage states for the accident progression analysis. It provides:

- the objective,
- the approach including assumptions,
- the structural modeling and analyses, and
- the potential damage states and their relative likelihoods for the seismic event considered.

The objective of the structural assessments was to provide damage states that might result from the seismic event described in the previous section and that would constitute the initial conditions for the accident progression analysis. Structural and related damage states have been divided into the following two major categories:

- (1) structural damage to the spent fuel pool structure with potential locations of leakage from concrete cracking and related liner tearing
- (2) other damage states including:
  - amount of water, if any, displaced by sloshing of the water out of the SFP
  - damage to the refuel gate, support systems and penetrations, as well as qualitative assessment of damage to spent fuel racks and spent fuel assemblies
  - damage to the reactor building and other relevant structures.

Most of the analytical effort focused on assessing potential structural damage to the spent fuel pool structure, namely concrete distortions, concrete cracking, and metallic liner strains.

Section 4.3 provides a review of the performance of SFPs at four nuclear power plant sites with a total of 20 reactors under two major recent earthquakes in Japan. This review compares relevant aspects of the seismic scenario and estimated damage states for this study with known aspects of the seismic scenario and performance of SFPs affected by those earthquakes. The review summarizes known or presumed reductions in water levels of the SFPs affected by those earthquakes associated with either water leakage from structural damage, if any, or water loss from sloshing. Although these reviews and comparisons use information available at the time of the execution of this study, they assist in the interpretation of the results obtained for the seismic scenario and SFP considered.

### 4.1 Damage States for the Spent Fuel Pool Structure

#### 4.1.1 Approach and Seismic Loads

The general approach for the estimate of the damage states follows the approach reported in NUREG/CR-5176, "Seismic Failure and Cask Drop Analyses of the Spent Fuel Pools at Two Representative Power Plants," issued January 1989 (Prassinis et al., 1989) modified to

address specific needs of this study. (The general approach is fully described in the following section.) The analyses reported in NUREG/CR-5176 were conducted in conjunction with research activities related to Generic Issue 82 (GI-82) (NRC, 2012c). Appendix 2 to NUREG-1738 (NRC, 2001), a technical study of spent fuel pool accident risk at decommissioning nuclear power plants, also addresses the seismic fragility of spent fuel pools and refers to the results and approach used in NUREG/CR-5176. The seismic evaluations in NUREG/CR-5176 considered ground motions with frequency content that differs from those considered in this study. Specifically, NUREG/CR-5176 considered ground motions with maximum response spectra amplitudes for frequencies below 10 Hz while the ground motions considered for this study have maximum response spectra amplitudes for frequencies greater than 10 Hz. This difference in the characteristics of the ground motions tends to induce conservatism in the approach when applied to this study as indicated below.

### Approach

The overall approach used to assess damage to the SFP structure, namely concrete cracking, concrete distortions, liner strains and liner tearing, for the earthquake event considered, consists of the following nine steps:

- (1) Obtain free-field acceleration response spectra (horizontal and vertical) for the site considered (a rock site and a reactor building with small embedment) as indicated in Section 3.3 and shown in Figure 7.
- (2) From reliable and well-documented past studies, obtain in-structure response spectra (ISRS) (also called floor response spectra) for the vertical and horizontal directions at the elevation of the base of the SFP (Elevation 195 ft). (For reference, the elevation at the top of the refueling floor is Elevation 234 ft and the elevation at the top of the foundation slab is Elevation 92 ft 6 in.) The SFP Study used the median-centered ISRS calculated for Peach Bottom for the seismic PRA performed for the NUREG-1150 study (NRC, 1990) and reported in Volume 4, Part 1, Revision 1 of NUREG/CR-4550 (Lambright et al., 1990).
- (3) Estimate ISRS for the ground motions of interest for this study at the elevations of interest (Step 2) by scaling the ISRS from previous studies (Step 2). The scaling accounts for differences in the response spectra for the NUREG-1150 seismic PRA and for this study. Given the differences in the ground motions for the NUREG-1150 PRA and for this study, the use of this scaling is likely to be near the limit of acceptability. Use of this scaling is justified on the basis that the approximations and uncertainties introduced are consistent with the uncertainties in other approximations used in the structural and seismic assessments for the study. It is expected that efforts by the NRC and industry related to Requests for Information in SECY-12-0025 (NRC, 2012f) associated with the Near Term Task Force (NTTF) Recommendation 2.1 (NRC, 2011a) will result in updated staff guidance on ISRS scaling.
- (4) Use the scaled ISRS from Step 3 to estimate equivalent static forces to be applied, in conjunction with dead loads, to the floor and walls of the SFP as input for a static nonlinear pushover analysis. These equivalent static forces account for (1) peak vertical and horizontal accelerations of the floor and walls of the SFP structure (seismic coefficients), (2) peak vertical and horizontal hydrodynamic impulsive pressures on the floor and walls of the SFP from the water in the pool and (3) vertical dynamic forces on the SFP floor from the dynamic response of the racks and spent fuel assemblies. At this

stage of the analysis also estimate vertical displacement of the water surface from sloshing.

- (a) Use a simplified three-dimensional (3D) finite element model of the SFP structure to estimate or verify these loads. Specifically, use elastic solid elements and special fluid elements to model the water to estimate natural frequencies and mode shapes for the SFP structure. Use this model to calculate the spatial distribution of peak vertical and horizontal accelerations of the structural components using the ISRS from Step 3 as input.
  - (b) Calculate hydrodynamic impulsive pressures and peak vertical and horizontal pressures on the basis of simplified methods (Housner, 1963; AEC, 1963; Malhotra et al., 2000). Use the 3D finite element model in Step 4a together with the ISRS from Step 3 as input to estimate peak hydrodynamic pressures. This provides for verification and adjustment of the hydrodynamic pressures calculated using simplified methods.
  - (c) Use the 3D finite element model in Step 4a together with the ISRS from Step 3 as input to estimate vertical displacements of the water surface from sloshing. The estimated displacements were small when compared to the depth of water in the SFP as indicated below.
- (5) Perform a 3D static nonlinear pushover analysis of the SFP structure using a detailed 3D finite element model of the SFP structure that includes nonlinear modeling of concrete including cracking as well as modeling of the steel reinforcement, embedded steel floor beams and the SFP liner. Such analysis provides the load deformation behavior of the SFP for the loading pattern and intensity considered. Perform the static nonlinear pushover analysis for adequate combinations of the vertical and horizontal ground motions to account for the fact that maximum vertical and horizontal accelerations do not occur simultaneously (NRC, 2006a). Accordingly, perform the nonlinear static pushover analysis as follows:
- (a) Incrementally apply the dead loads to the SFP structure to calculate initial stresses and strains. Dead loads considered for this study consist of: the weight of the pool structural components, weight of water, weight of the spent fuel assemblies and weight of the spent fuel racks.
  - (b) Follow Step 4a with an incremental application of adequate combinations of the horizontal and vertical equivalent static forces estimated in Step 4. The incremental application is needed to track development and effects of concrete cracking, concrete strains, steel yielding and liner strains.
  - (c) Based on guidance for combining effects from three spatial components of an earthquake in Regulatory Guide 1.92 (NRC, 2006a), peak vertical seismic loads were combined with 40-percent of the peak horizontal loads. A combination of peak horizontal loads on both directions with 40-percent of the vertical loads was also considered. Preliminary analyses indicated that the load combination involving peak vertical loads and 40-percent of the horizontal loads would likely be the most severe combination for the SFP structure analyzed. Accordingly, this was the combination studied in more detail in the remainder of the study.
  - (d) Use best-estimate median material properties for all materials (e.g., concrete, reinforcement, steel beams and liner) based on best available information for similar materials used in nuclear plants and other guidance for the assessment of beyond-design-basis events and for seismic fragility assessments. Also take into

account the effect of aging on the concrete strength as recommended for the assessment of beyond-design-basis events (NEI, 2011; Prassinos et al., 1989).

- (6) Review and process the calculated structural distortions (as measured by the displacement of nearby nodes), structural deformations, concrete strains and liner strains for the following purposes:
  - (a) Assess the possible development of cracks through the floor or walls (the analyses indicated that critical concrete cracking such as this would only develop at the base of the walls along the intersection of the SFP walls with the SFP floor) and then estimate crack lengths and average crack width.
  - (b) Assess liner strains at the intersection of the base of the walls and floor slab in order to assess the potential for liner tearing. Take into consideration details of the attachment of the liner, in discrete locations, to the concrete floor and walls.
- (7) Define three initial states for the subsequent accident progression analysis as follows:
  - (a) A state with no leakage, and no loss of coolant, from the bottom of the SFP. This state corresponds to concrete cracking at the base of the walls (estimated to be through-wall cracking for the event considered as shown in subsequent subsections) but without tearing of the liner.
  - (b) A state with moderate leakage rate from the bottom of the SFP, corresponding to through-wall concrete cracking at the bottom of the walls with tearing of the liner that propagates to an extent such that water leakage is controlled by the size of the cracks in the concrete.
  - (c) A state with small leakage rate from the bottom of the SFP, corresponding to through-wall concrete cracking at the bottom of the walls and tearing of the liner that remains localized such that water leakage is controlled by the size of the tearing in the liner.
- (8) For the two damage states with leakage, estimate the leakage rate at the base of the SFP walls. When the rate is controlled by the cracking in the concrete (moderate leakage rate) use recent large scale test data for the flow of water through thick concrete slabs together with the estimated crack width and length to estimate the leakage rate. When the rate is controlled by localized liner tearing, use empirical data from leakage through cracks in steel pipes to estimate the leakage rates.
- (9) Use data for ultimate strains in the types of steel used for SFP liners, together with uncertainties in the calculated liner strains as well as uncertainties in the estimation of the in-structure loads and concrete properties to estimate the relative likelihoods for the three initial damage states listed in Step 8 - no leakage, moderate leakage rate and small leakage rate.

As noted above, this approach parallels part of the approach used in conjunction with the resolution of GI-82 (Prassinos et al., 1989). It augments the earlier approach in that it uses modern finite element methods in Steps 4 and 5. The use of finite element analyses in Step 4 is done to obtain a more accurate assessment of the natural frequencies of the SFP structure itself, to estimate the spatial distribution of seismic coefficients and to verify and adjust hydrodynamic impulsive loads on the floor and walls of the SFP. The use of finite element analyses in Step 5 is done to track the development of cracking and liner strains and then relate those to damage states, leakage rates and their relative likelihoods.



The approach described above has potentially conservative aspects that may overestimate the damage to the SFP structure. These conservative aspects are as follows:

- As the high-frequency structure of the SFP (fundamental frequency on the order of 15 to 25 Hz) cracks under the applied seismic loads, its natural frequencies decrease and are no longer resonant with the high frequency components of the ground motion (i.e., the frequencies corresponding to the higher spectral accelerations). Since the spectral accelerations decrease as the frequencies of the SFP structure decrease after cracking, the use of seismic loads calculated assuming elastic frequencies can introduce conservatism in the analysis for the seismic event considered. This would be the case if the SFP structure were to remain stable with only minor distortions after cracking as in the case of the SFP studied. This aspect was partially accounted for in this study through a small reduction in the spectral accelerations and by the use of a small reduction of the concrete stiffness in the calculation of the natural frequencies of the SFP structure. Assessment of the conservatism introduced by the approach used, which was outside the scope of this study, would involve the sampling of representative acceleration time-histories, both vertical and horizontal, and their use in time-history analyses of the SFP response to the seismic loads considered.
- Generally ISRS accelerations do not increase proportionally (linearly) from low PGA events to an event with a PGA as high as that considered in this study. As the load increases, both the structure of the reactor building and of the SFP may crack and dissipate energy thus dampening the response of the building. This effect is taken into account, in part, by reducing ISRS spectral accelerations by the ratio of spectral amplification factors for 10-percent and 5-percent damping (Newmark and Hall, 1978). The reduction of spectral accelerations implied by the use of a higher damping ratio is further justified by the decrease in the fundamental frequency of the structure related to cracking which, for the input free-field ground motion for this study (see Section 3.3 and Figure 9), would decrease the spectral accelerations.
- Another potentially conservative aspect of the analysis is that the scaling of the ISRS does not take into account reductions on the high-frequency (greater than 10 Hz) spectral accelerations that may result, under some circumstances, from ground motion incoherency, wave scattering, soil-structure interaction effects and wave passage effects. This is accounted for, in part, in the calculation of the relative likelihood of the various damage states by considering a small range of reduction in the response and associated uncertainties, as discussed below.

Other approximations of note include (1) the scaling of ISRS calculated from a ground motion with response spectra markedly different from the ground motion spectra considered for this study (addressed in item 5(c)), (2) the decoupling of the response of the SFP from the response of the reactor building, and (3) neglecting the small embedment of the reactor building, as also done in previous studies, which may affect the calculation of horizontal ISRS. Follow-on subsections address these and the above approximations. More detailed approaches involving the use of sampled time-histories, including sampling of incoherent ground motions, used in conjunction with 3D models of the entire reactor building and soil-structure interaction analysis, to calculate loads on the SFP would provide a better assessment of these possible conservatisms. However, these were outside the scoping nature of the study.

The weight of other SFP equipment and appurtenances on the dead loads, and thermal stresses are not accounted for explicitly in the estimation of the initial stresses in the SFP components (Step 5a). The weight of those equipment and appurtenances is expected to be

small in comparison to the other dead loads in the pool and accounted for by the approximations in the estimation of those dead loads. Thermal stresses are not accounted for under the assumption that concrete cracking will relieve the thermal stresses. Moreover, increase in the temperature of the water, if it were to occur, would not happen until several hours after the termination of the ground shaking.

### Seismic Loads

Chapter 3 of this report discusses the bases for the free-field ground motion response spectra for the seismic event considered for the SFP Study. As noted in Chapter 3 other free-field response spectra of interest in this study are those documented in NUREG/CR-4550 (Lambright et al., 1990) and used in the probabilistic risk assessment (PRA) for NUREG-1150. That report provides median-centered ISRS (for 5-percent damping) for the Peach Bottom reactor structures calculated using time-history analysis and an ensemble of free-field ground motion time-histories. Section 3 provides a comparison of the median-centered free-field ground motion response spectra for that ensemble of time-histories to the ground motion response spectrum for the seismic event considered in this study.

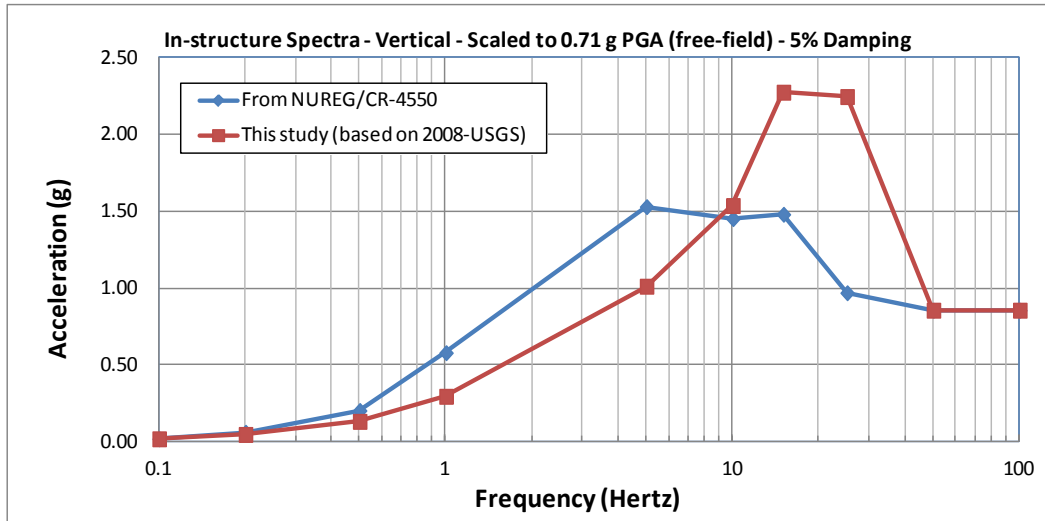
The free-field response spectra and ISRS reported in Lambright et al. (1990) form a set of reliable and well-documented response spectra for the Peach Bottom reactor buildings. Specifically, that report provides ISRS at various elevations of interest in the reactor building, namely at the bottom elevation of the SFP (Elevation 195 ft) and at the refueling floor (Elevation 234 ft). In addition, the report also provides estimates of natural frequencies of vibration for the reactor building, which are listed in Table 6. These frequencies help understand the shape of the ISRS for the Peach Bottom reactor building. It is noted that the dominant, elastic (uncracked) frequencies of vibration of the SFP structure, considering hydrodynamic effects of the water and the mass of the spent fuel, range from about 17 Hz (vertical response of the floor slab) to 28 Hz (horizontal deformations of the walls). These frequencies are remote (detuned) from the frequencies for the horizontal mode of vibration for the reactor building but are close to its vertical frequency.

**Table 6 Estimated Natural Frequencies of Vibration for the Peach Bottom Reactor Building (Lambright et al., 1990)**

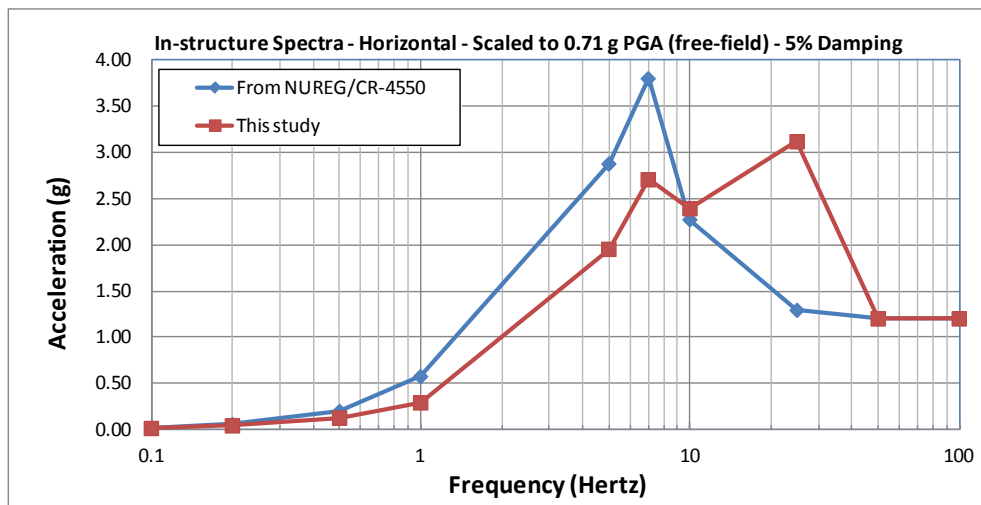
Direction	Frequency (Hz)	% Mass
Horizontal (NS)	7.1	68
Horizontal (EW)	7.6	71
Vertical	18.5	72

Using simplified scaling procedures, the ISRS in Lambright et al. (1990) were scaled to estimate floor vertical and horizontal ISRS at the elevation at the bottom of the SFP (Elevation 195 ft) as well as horizontal ISRS at the midheight of the SFP walls (by averaging scaled spectra at Elevation 195 ft and Elevation 234 ft). The scaling was done by estimating the ground motion amplification factors from the ground motion to the ISRS and then applying those factors to the response spectra for the SFP study. This scaling was done using the reported median-centered ISRS for 5-percent damping, the vertical and horizontal (EW) components for the ISRS (examination of the charts indicates that the horizontal (EW) component tends to have the higher spectral accelerations). The SFP Study considered identical horizontal ISRS for both directions. Note that for the SFP studied the horizontal components of the ground motion are not those with the greatest damage potential. Justification for not considering reductions in the high frequency spectral accelerations is provided at the end of this subsection.

Figure 10 shows a comparison of the vertical ISRS for the elevation at the bottom of the SFP, calculated as indicated above to the corresponding ISRS (smoothed) for the NUREG-1150 seismic PRA. Likewise, Figure 11 provides a similar comparison for the horizontal ISRS at the midheight of the SFP structure (average of the ISRS at Elevation 195 ft and Elevation 234 ft).



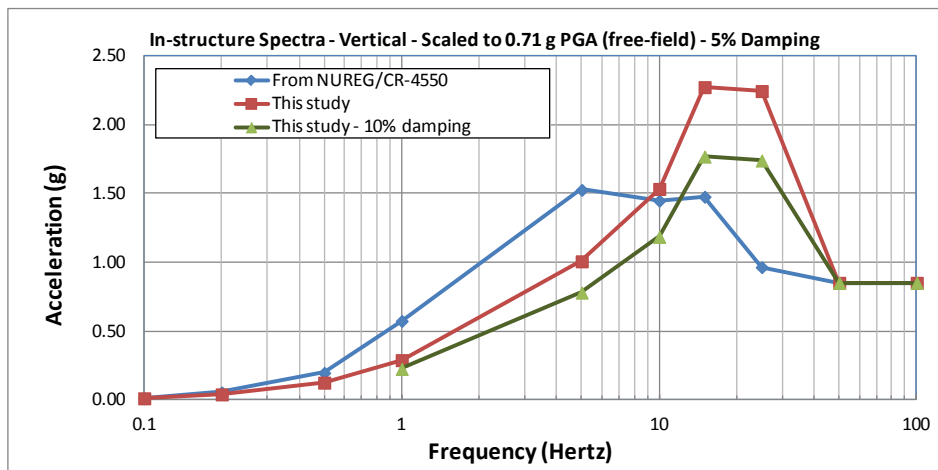
**Figure 10 Vertical ISRS for 5-percent damping at Elevation 195 ft (bottom of the SFP)**



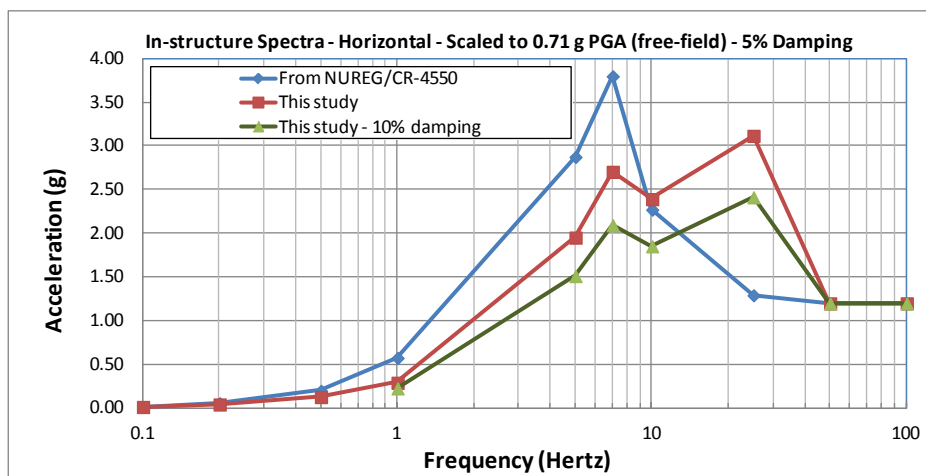
**Figure 11 Horizontal ISRS for 5-percent damping midway between Elevation 195 ft and Elevation 234 ft (midheight of the SFP)**

The spectra shown in Figure 10 and Figure 11 are for 5-percent damping (reactor building and equipment). Calculation of seismic load coefficients for the SFP floors and walls as well as of hydrodynamic impulsive pressures considered a reduction of these spectral accelerations. Specifically, seismic coefficients and hydrodynamic pressures calculated using the 5-percent damping ISRS were reduced by the ratio of scaling factors for 10-percent and 5-percent damping reported in NUREG/CR-0098 (Newmark and Hall, 1978). As noted above, this is done to account for, in part, the energy dissipation (damping) from cracking of the SFP and minor

cracking of the reactor building. This is further justified by the reduction in the natural frequency of the SFP structure from cracking that would lead to reduced spectral accelerations for the input free-field ground motion (see Section 3.3 and Figure 9). An assumption is, for example, that for the intense ground motion of the event considered, the reactor building will undergo more cracking than that estimated for the design basis motion (SSE). This will absorb and dissipate energy and damp the response. ISRS obtained by reducing the 5-percent damping ISRS in this manner, herein called 10-percent damping ISRS, are shown in Figure 12 and Figure 13.



**Figure 12 Vertical ISRS for 5-percent and 10-percent damping at Elevation 195 ft (bottom of the SFP)**

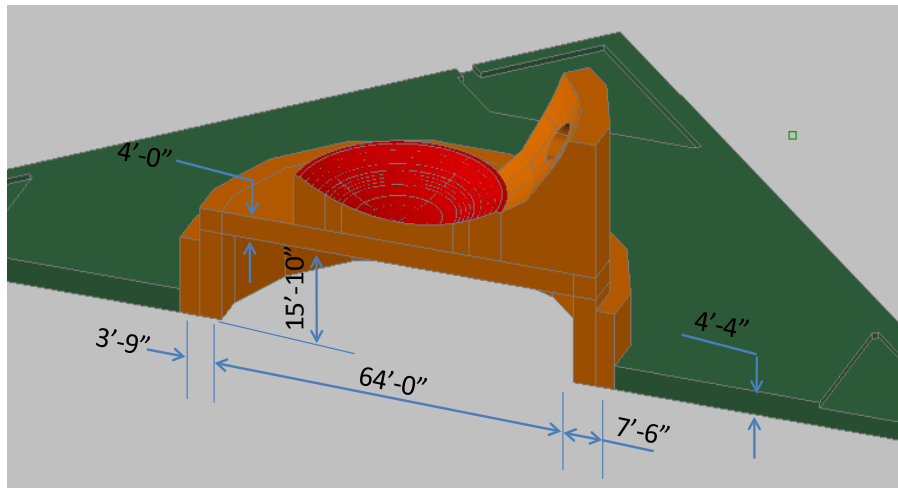


**Figure 13 Horizontal ISRS for 5-percent and 10-percent damping midway between Elevation 195 ft and Elevation 234 ft (midheight of the SFP)**

The scaling used to obtain the 5-percent damping ISRS does not take into account reductions on spectral accelerations for frequencies greater than 10 Hz that would result, under some circumstances, from ground motion incoherency, wave scattering, soil-structure interaction effects and wave passage effects. The plant dimensions of the reactor building are about 150 ft by 120 ft above Elevation 135 ft (ground elevation) and about 150 ft by 150 ft below Elevation 135 ft. The building foundation consists of a 4 ft 4 in. reinforced concrete (RC) slab lying on top of sound rock with an elevated rock pedestal about 64 ft in diameter near the center for the

drywell foundation (see Figure 14). The foundation slab above this rock pedestal is still an RC slab about 4 ft thick. The main structure of the reactor building extends from the top of the foundation at Elevation 92 ft 6 in. to the refueling floor at Elevation 234 ft, which is topped by a structural steel crane bay (rated at 120 tons). For this relatively complex and relatively flexible foundation, justification for large reductions on high frequency ISRS spectral accelerations is arguable. The distance between the supports of the SFP structure, which provide direct pathways from the vertical ground motions of the rock to the SFP, is on the order of about 65 ft. This distance is less than the distance that has been considered appropriate for justifying large reductions of high frequency ISRS spectral accelerations (ASCE 1999).

The above notwithstanding, results of past studies justify consideration of some reduction of the high-frequency ISRS spectral accelerations even without further analysis. Possible reduction of high-frequency ground motions is accounted for, in part, in the subsequent calculation of the relative likelihood of the various damage states. This is done by considering a narrow range of reduction in the response and associated uncertainties, as discussed in Section 4.1.5.



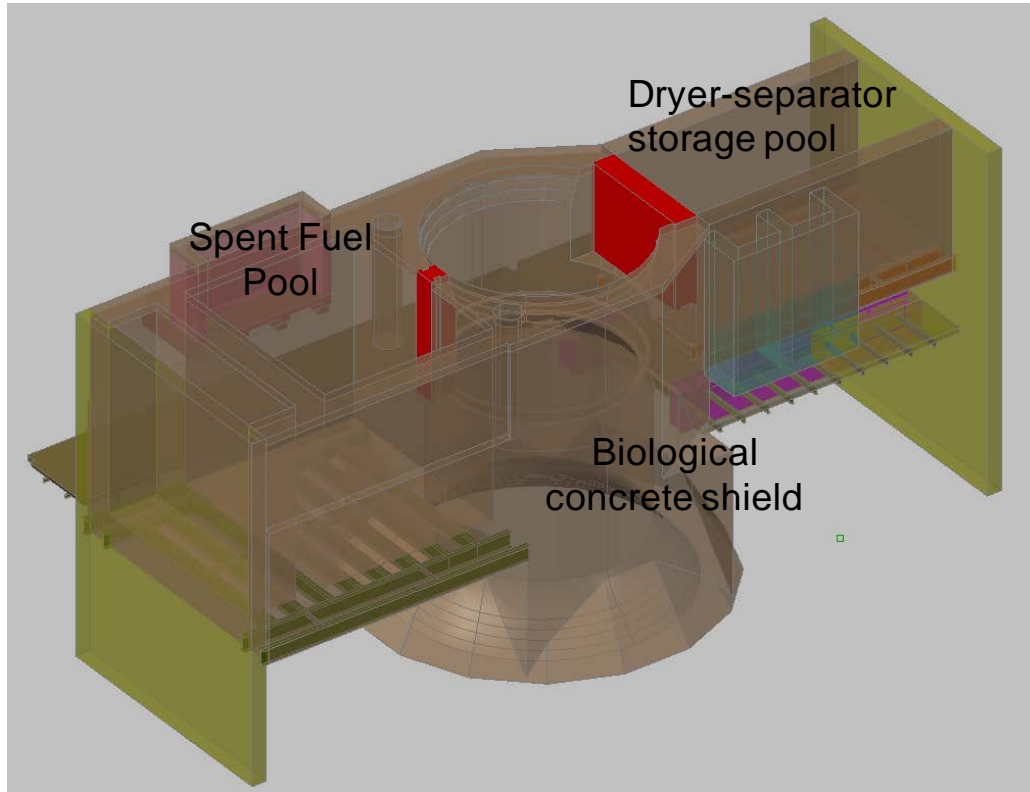
**Figure 14 Schematic diagram of the reactor building foundation near the drywell**

#### 4.1.2 Description of the Spent Fuel Pool Structure

This section provides a brief description of the SFP structure and its relation to the main reactor building. The description identifies the main structural components and other aspects relevant for this study.

The final safety analysis report (FSAR) for PBAPS describes the SFP and the dryer-separator storage pool as a large channel-shaped beam (approximately 40 ft wide at the SFP structure). This channel beam is supported at the center by the biological concrete shield structure around the drywell and at the ends by RC exterior walls on opposite sides of the reactor building. Figure 15 is a 3D representation of the SFP structure and dryer-separator storage pool. Figure 16 shows cutouts of 3D models of the reactor building that show the location of the SFP in relation to the remainder of the building. The 3D model on the left-hand-side of that figure ends at the elevation of the refueling floor (Elevation 234 ft) while the model on the right shows the crane bay located above the refueling floor (but not the crane itself).

The detailed 3D finite element model of the SFP structure itself (see Figure 17) serves to identify the walls of the pool for further reference in this study. The east (E) and west (W) walls extend from the biological concrete shield to the outer wall of the reactor building. These walls, which are about 40 ft deep (above the top of the SFP floor) and about 6 ft thick in their lower half, support the entire weight of the SFP, which includes their own weight, the weight of the floor, water, spent fuel assemblies, spent fuel racks, and the partition wall (south, S, wall). The E and W walls are supported by the thick RC biological shield building on the north (N) side and by the outer wall of the building (on the south side). A cavity exists between the SFP itself and the outer wall of the reactor building.



**Figure 15 SFP details in cutout of 3D CAD model**



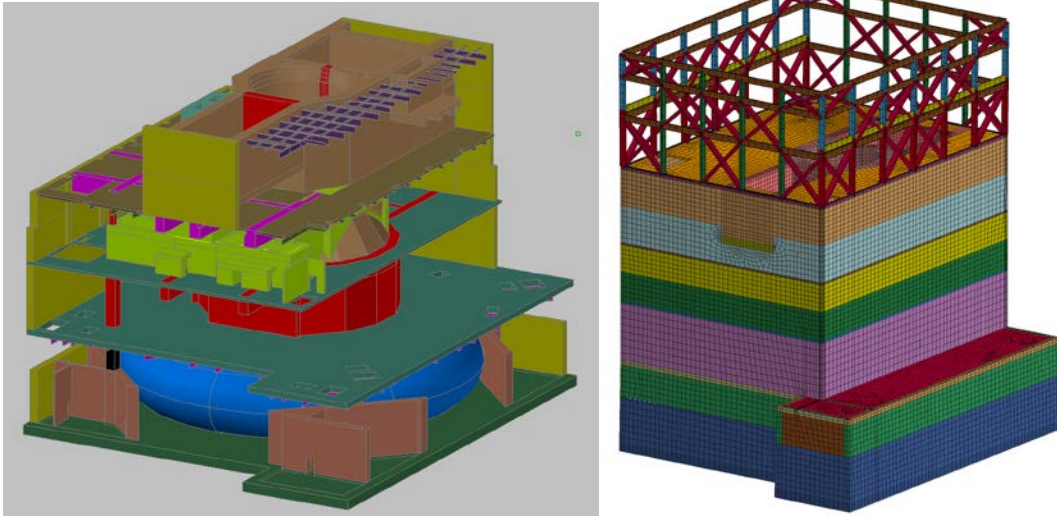


Figure 16 Cutouts of 3D CAD models of the reactor building and SFP

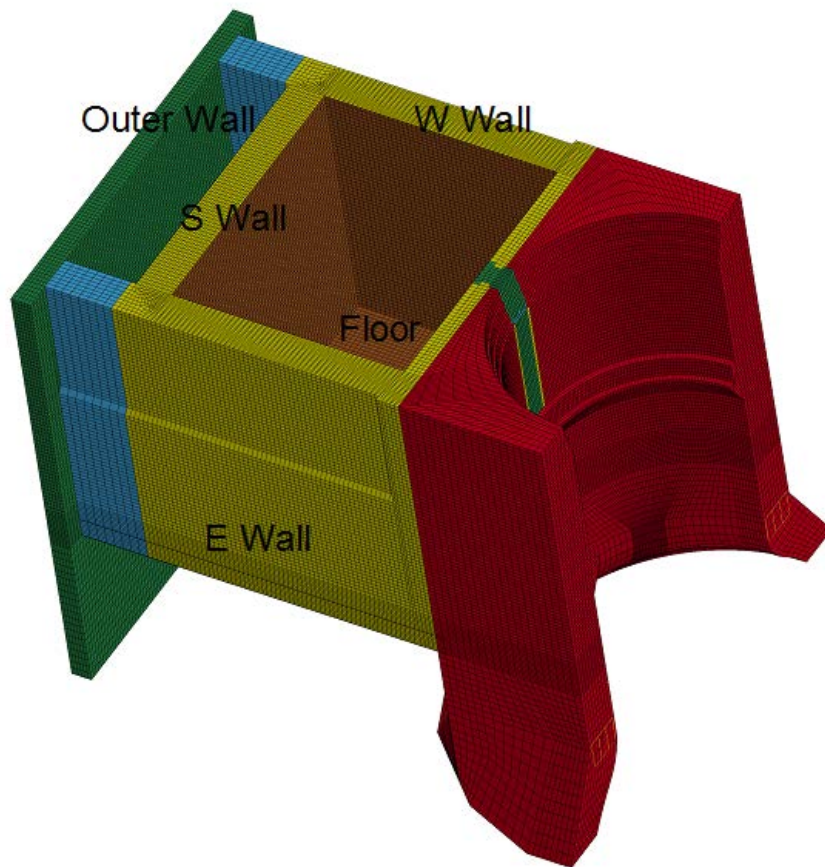
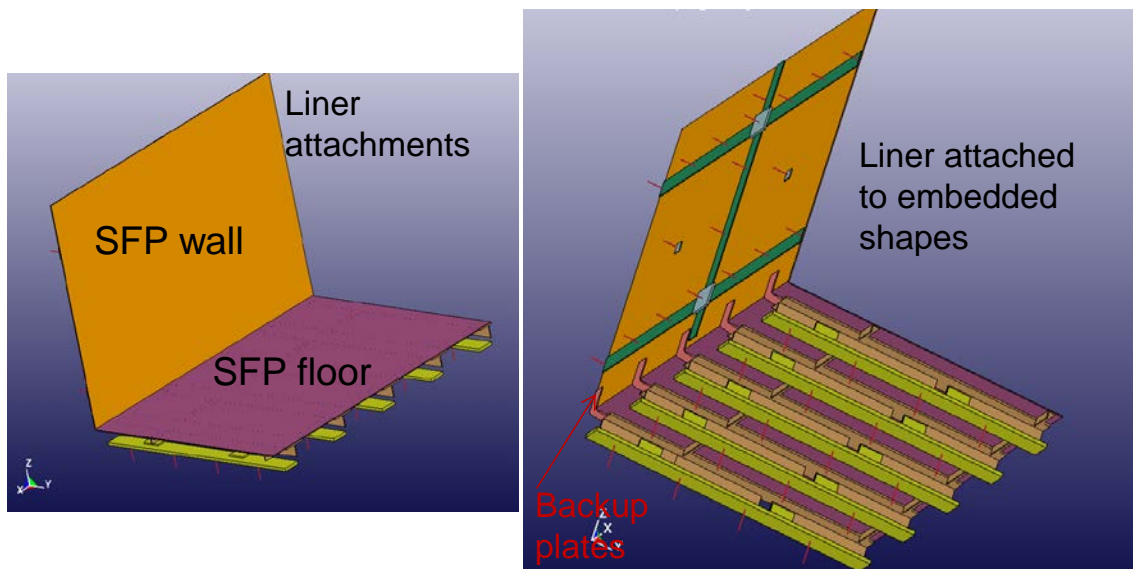


Figure 17 Finite element model of the SFP structure with labels for the floor and walls

Of interest for the study is assessment of damage and cracking to the walls identified in Figure 17 as well as to the floor of the pool from the low probability, seismic event considered in this study. The walls are RC walls with vertical and horizontal layers of #11 (1.41 in. diameter) reinforcing steel bars near each face as well as near the mid surface of the walls.

The SFP floor consists of an RC slab 6 ft 3 in. thick, with embedded heavy steel W-Shapes (I beams) as shown in Figure 15. This floor framing was used during construction and designed to carry the weight of the wet concrete but the beams and decking were left embedded in the concrete floor to the depth of the lower flange of the shapes. The beams that extend from the biological concrete shield to the outer wall are W-36x300 (3 ft deep beams weighing about 300 pounds per foot) and those extending from one wall to the other are W-36x230 (3 ft deep and weighing about 230 pounds per foot). The floor is reinforced with steel rebar layers in two directions at the top of the floor and with a complex reinforcing pattern in between the steel girders within the clear span of the floor as well as in the portion of the floor under the side walls of the SFP. Vertical reinforcement near each face of the wall extends vertically into the floor slab and some of those bars bend and then extend horizontally into the upper half of the pool floor. This is done to provide adequate embedment to the reinforcing bars.

The floor and walls of the SFP are covered with a 1/4-in. thick stainless steel liner which is designed to preclude inadvertent loss of water and that is attached to the concrete using steel anchors, and welds to steel plates and shapes embedded in the concrete floor and side walls. Figure 18 , which is an outline of the 3D finite element model of a portion of the liner and its attachments to the concrete floor and walls (E and W walls), is used to identify some of these attachments. Interconnected drainage paths are provided behind the liner for drainage of small amounts of water that might leak through small cracks to a sump drain.



**Figure 18 Outline of detailed finite element model of the SFP liner representing attachments to the SFP floor and walls (E and W walls)**

According to the FSAR, there are no connections to the SFP that would allow water to drain below the refueling gate or below 10 ft above the top of active fuel. The FSAR further states that lines below the levels in the previous sentence are equipped with siphon breaker holes to prevent inadvertent drainage. In addition, the systems for maintaining water quality and quantity



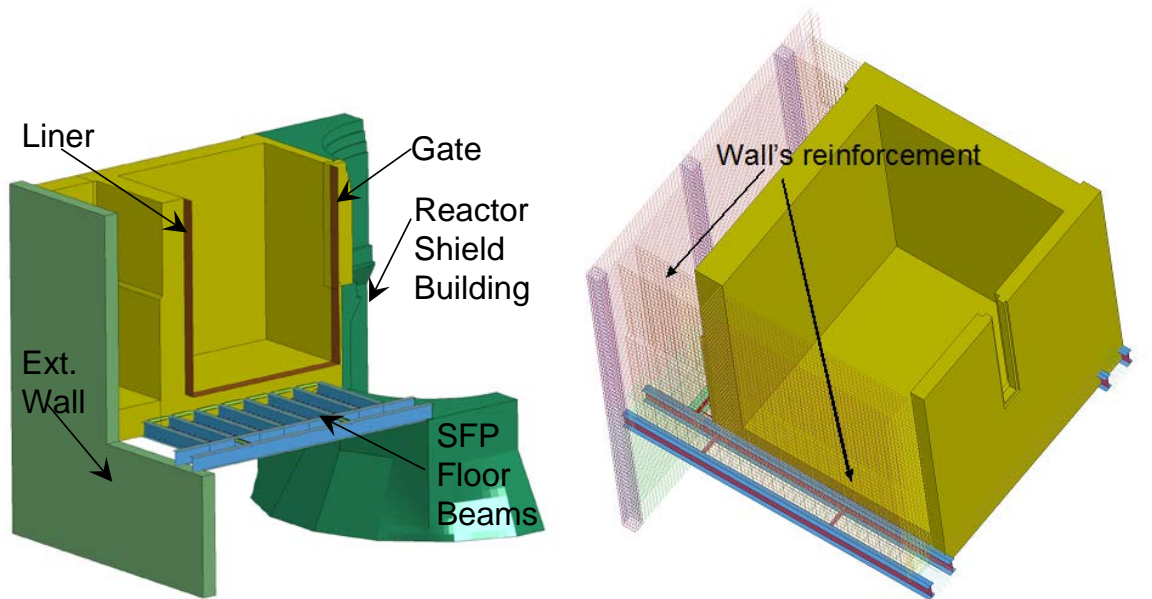
are designed so that failure or inappropriate operation of these systems does not cause uncovering of the fuel.

The refueling gate opening (in red in Figure 15) is covered with concrete blocks and closed by two steel gates, in which one steel gate backs the other to provide redundancy in the case of malfunction of a single gate. Each gate consists of steel plates with steel stiffeners. Each gate has polymeric seals around its perimeter that are kept under pressure by the mechanical locking system for the gates. Pressurization of the seals is not a pneumatic system that requires pressurization by electric power systems.

#### 4.1.3 Finite Element Model Description

Step 5 of the approach described in section 4.1.1, the nonlinear pseudodynamic analysis of the SFP under the combined dead loads and seismic loads, requires a detailed finite element model of the entire SFP structure in order to estimate concrete cracking and liner strains for the estimation of leakage areas. The LS-DYNA finite element software was used for the analysis (LSTC, 2007). Figure 17 shows the overall detailed finite element model. The model has about 600,000 elements and uses 16 elements through the thickness of the E and W walls and equally refined detail for the SFP floor.

The finite element model included all major reinforcing bars for the floor and walls of the SFP structure as well as the outer walls and biological concrete shielding. This model also considered all steel shapes embedded in the floor of the SFP which were modeled using LS-DYNA shell elements. In addition, the finite element model also includes the steel liner on the inside surface of the SFP. Figure 19 shows some of the components included in the finite element model.



**Figure 19 Cutouts of 3D finite element model showing components included in the model**

Given the complexity of the structure, rather than using node-to-node modeling for the embedded shell elements modeling the steel beams, the model used the “Constrained

Lagrange in Solid” option available in LS-DYNA to represent the coupling between the embedded elements and the concrete. For the steel liner, two levels of modeling detail were used. In the calculation of the overall response of the SFP to the combined loads, liner shell elements of the size of the underlying concrete elements were used and the liner was assumed to be bonded to the concrete (node-to-node connections). A more detailed model of sections of the liner (see Figure 18 above) with elements as small as 3.7 millimeters (mm) (0.15 in.) wide was subsequently used as an embedded gage to assess strain concentrations in the liner plates at the intersection of the floor and walls as discussed in the following section.

Boundary conditions for the nonlinear finite element analysis are as follows: (i) vertical and horizontal displacements fixed at the bottom of the exterior wall and of the radiological concrete shield building; (ii) horizontal displacements fixed at the edges of the exterior wall and at the edges of the radiological concrete shield building; and (iii) horizontal displacements in the direction perpendicular to the E and W walls fixed at the top of the E and W walls from the exterior wall to the radiological concrete shield building. Fixing the horizontal displacements at the top of the E and W wall in the direction perpendicular to the walls is justified on the basis of the 1 ft 7 in. thick composite floors with a reinforced concrete deck continuous with the SFP walls on each side of the SFP at the top of the E and W walls (Elevation 234 ft) and that extend to the exterior walls.

The finite elements in the model for the nonlinear analysis are as follows:

- reinforcing bars—LS-DYNA beam elements with the truss option.
- concrete—Constant stress LS-DYNA solid elements (reduced integration)
- shell elements—Belytschko-Tsay shell elements.

Two material models were used as follows:

- Concrete—LS-DYNA material model 159 known as the Continuous Surface Cap Model (CSCM) (FHWA, 2007). The analysis used the option of specifying a minimum number of material properties, namely the unconfined compressive strength and aggregate diameter and allowing the model to calculate the other material properties of interest.
- Steel—LS-DYNA material model 3, called plastic kinematic, which was used for all steels but with different material properties.

Table 7 provides a summary of the material properties used in the nonlinear finite element analyses. The properties for the concrete and steel reinforcement, assumed to be the materials that would most influence the overall response of the SFP, were taken to be best estimates of the median material properties. In the case of concrete, the unconfined compressive strength of the concrete was estimated based on recommendations used for the analysis of extreme events, namely aircraft impact assessment (NEI, 2011) and a nominal concrete strength of 4,000 pounds per square inch (psi) (27.5 MPa). For the other materials, the table primarily lists nominal properties. In the case of the liner, nominal material properties were assumed for its yield strength and Young’s modulus. These properties and the liner itself are not expected to have a significant effect in the overall response of the SFP structure. However, liner strains and failure strains for the liner are critical in assessing the leakage potential for the SFP. An approach to assess failure of steel liners in reinforced concrete containments is used together with simple probabilistic models to estimate the relative likelihood of the damage states as described in Section 4.1.5.

**Table 7 Material Properties for the Nonlinear Finite Element Analyses**

Material	Properties	
Concrete	Unconfined compressive strength	6,400 psi (44.6 MPa)
	Aggregate diameter	1.5 in. (38 mm)
	Unit weight (and density)	145 lb/ft <sup>3</sup> (2.33 g/cm <sup>3</sup> )
	Young's Modulus (for reference)	4.5x10 <sup>6</sup> psi (31,000 MPa)
Rebars	Yield strength (Grade 40)	47,850 psi (330 MPa)
	Yield strength (Grade 60)	69,000 psi (475 MPa)
	Young's modulus	31x10 <sup>6</sup> psi (2.15x10 <sup>5</sup> MPa)
	Tangent modulus	15x10 <sup>4</sup> psi (1000 MPa)
	Unit weight (and density)	479 lb/ft <sup>3</sup> (7.7 g/cm <sup>3</sup> )
	Failure strain	0.10
Liner and steel plate anchorages	Yield strength (Grade 40)	36,000 psi (250 MPa)
	Young's modulus	30x10 <sup>6</sup> psi (2.07x10 <sup>5</sup> MPa)
	Tangent modulus	15x10 <sup>4</sup> psi (1,000 MPa)
	Unit weight (and density)	479 lb/ft <sup>3</sup> (7.7 g/cm <sup>3</sup> )
	Failure strain	Treated as variable
Beams	Yield strength	36,000 psi (250 MPa)
	Young's modulus	30x10 <sup>6</sup> psi (2.07x10 <sup>5</sup> MPa)
	Tangent modulus	25x10 <sup>4</sup> psi (1,700 MPa)
	Unit weight (and density)	479 lb/ft <sup>3</sup> (7.7 g/cm <sup>3</sup> )
	Failure strain	0.10
Anchor studs	Yield strength	36,000 psi (250 MPa)
	Young's modulus	30x10 <sup>6</sup> psi (2.07x10 <sup>5</sup> MPa)
	Tangent modulus	25x10 <sup>4</sup> psi (1,700 MPa)
	Unit weight (and density)	479 lb/ft <sup>3</sup> (7.7 g/cm <sup>3</sup> )
	Failure strain	0.10

This study used a simpler version of the model used for the nonlinear analysis. This model was used to estimate frequencies of vibration for the SFP structure, to estimate seismic load coefficients and to verify hydrodynamic impulsive pressures with the ANSYS (version 13) finite element software (ANSYS, 2011). The simplified finite element was used with linear analyses appropriate for its intended use, had fewer elements through the thickness of the walls and floor, and it had a simpler representation of the concrete biological shielding.

This finite element model used solid, elastic finite elements to represent the structure of the SFP (concrete only) and fluid elements to represent the water. Specifically, it used the ANSYS SOLID185 element, a 3D structural solid element, and the ANSYS FLUID80 element for the modeling of the water. Material properties considered with this model are as follows:

- Concrete: (1) Young's modulus of 3.15x10<sup>6</sup>psi (reduced to 70-percent of the Young's modulus of reference to account partially for cracking effects on stiffness) (21,700 MPa), (2) unit weight of 145 lb/ft<sup>3</sup> (2.33 g/cm<sup>3</sup>), and (3) a Poisson ratio of 0.15.
- Water: (1) bulk modulus of 3.16x10<sup>5</sup> psi (2,180 MPa), (2) unit weight of 62.4 lb/ft<sup>3</sup> (1 g/cm<sup>3</sup>), and (3) a viscosity of 1.64x10<sup>-7</sup> psi-s (1.13x10<sup>-9</sup> MPa-s).

The simplified finite element model was used in conjunction with the following analyses:

- Estimation of frequencies and modes of vibration for the SFP including the effects of water using Householder reduced methods for the low frequency modes and the Block Lanczos method for the high frequency modes.
- Related deterministic spectrum analysis using single-point spectral accelerations at the supports together with the complete quadratic combination (CQC) rule for the combination of modal responses. These analyses were done to estimate seismic load coefficients for structural components and to verify the magnitude of the hydrodynamic pressures on the SFP walls.

**Summary of Dead and Seismic Loads for the Finite Element Analysis**

As indicated in Section 4.1.1, the dead loads considered for the nonlinear seismic analysis are the weight of structural materials (concrete, reinforcement, steel beams, liner and other steel plates), the vertical and horizontal hydrostatic pressures of the water, and the weight of the spent fuel assemblies and racks. The weight of the structural elements was applied as gravity loads on the finite element analysis. Hydrostatic pressures were applied as vertical and horizontal pressures on the inside surfaces of the floor and walls of the SFP. Vertical loads on the SFP floor from the weight of the spent fuel assemblies and racks were also applied as pressures on the SFP floor. Table 8 lists approximate values of the dead loads on the SFP floor in terms of an equivalent vertical pressure on the SFP floor for the purpose of comparing the magnitude of these loads with those imposed by the earthquake. Table 9 has approximate values of peak equivalent seismic static loads (vertical) expressed in terms of an equivalent vertical pressure on the SFP floor. Horizontal hydrodynamic loads (not shown in Table 9) considered hydrodynamic pressures from the horizontal ground motions as well as pressures on the wall from the vertical ground motions.

**Table 8 Approximate Dead Loads on the SFP Floor in Terms of an Equivalent Vertical Floor Pressure**

Load	Approximate equivalent floor pressure in lb/ft <sup>2</sup> (in kPa in the parentheses)
Weight of the floor	900 (43)
Vertical hydrostatic pressure	2,300 (110)
Weight of spent fuel assemblies and racks	1,700 (80)
Total	4,900 (230)

**Table 9 Approximate Peak Equivalent Seismic Loads in Terms of an Equivalent Static Vertical Floor Pressure**

Load	Approximate equivalent floor pressure in lb/ft <sup>2</sup> (in kPa in the parentheses)
Floor slab acceleration	1,400 (67)
Hydrodynamic impulsive vertical pressure	4,840 (230)
Dynamic forces from spent fuel assemblies and racks	1,750 (85)
Total	7,990 (385)

The results shown in Table 8 and Table 9 indicate that the seismic loads (in terms of equivalent vertical pressures on the SFP floor) are approximately twice as large as the dead loads and that the hydrodynamic impulsive pressures on the SFP floor are the largest of all forces considered.

Finite element analyses with the simplified finite element model described above were used to estimate and verify the seismic forces listed in Table 9 using deterministic response spectrum analysis. The seismic input for this analysis was a single point spectral acceleration at the supports using the 5-percent vertical and horizontal ISRS described in Section 4.1.2. It is noted that the (lower) natural frequencies of the SFP, considering a reduction of the concrete Young's modulus to about 70-percent of its original value, the water, and the mass of the spent fuel assemblies and racks, range from about 14 Hz (vertical motion of the floor) to 24 Hz (horizontal motion of the walls). These are frequencies of interest for the estimation of both hydrodynamic impulsive pressures (vertical and horizontal) as well as peak accelerations of the floor (vertical) and walls (horizontal). Comparison of these natural frequencies with the free-field response spectra for this study shown in Chapter 3 of this report indicates that these frequencies are similar to those for which the ground motions for this study have spectral accelerations higher than those from the SSE when scaled to the same PGA.

Figure 20 shows contours of the peak vertical accelerations of the SFP floor obtained using the deterministic response spectrum analysis described in the previous paragraph with the vertical ISRS as a single point spectral acceleration input at the supports. The results shown are for a free-field PGA of 1.0g and 5-percent damping ISRS. They were multiplied by 0.71 and by the ratio of spectral amplitudes for 10-percent and 5-percent damping to estimate the peak accelerations (seismic coefficients) to be used as input for the nonlinear finite element analysis. To obtain corresponding forces for the nonlinear analysis, the area of the SFP floor was divided into a 4-ftx4-ft grid and the peak vertical accelerations were sampled at the center of each element of this grid. These sampled peak accelerations were then used to calculate equivalent nodal forces for the nodes of the detailed LS-DYNA finite element model for the nonlinear analysis. Estimation of equivalent nodal forces for the walls, both horizontal and vertical used a procedure analogous to that described for the vertical forces on the SFP floor.

Vertical hydrodynamic forces, which are proportional to the vertical spectral accelerations at the base of the SFP, are the largest seismic forces in Table 9. Given the significance of these pressures, deterministic response spectrum analysis with the simplified ANSYS finite element model of the SFP was used in their calculation. Figure 21 shows peak hydrodynamic vertical pressures calculated in this manner for the vertical ISRS at the supports of the SFP (taken to be the same at each support). The pressures shown in Figure 21 are for a free-field PGA of 1.0g and the 5-percent damping ISRS. They were multiplied by 0.71 for the PGA of interest and by the ratio of spectral amplitudes for 10-percent and 5-percent damping to obtain the values shown in Table 9. Note that water pressures from the vertical accelerations also apply hydrodynamic pressures to the walls, which decrease with height above the floor. The analysis accounted for these pressures.

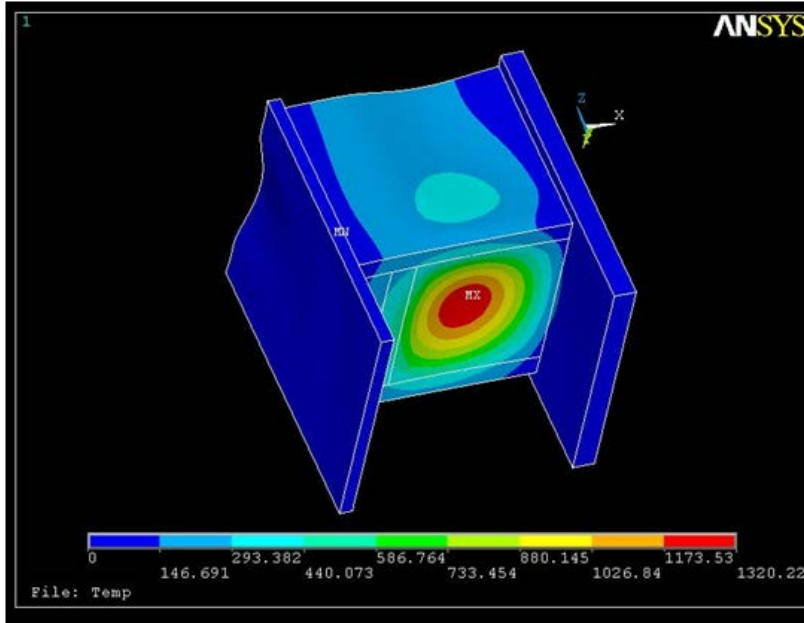


Figure 20 Estimated peak vertical accelerations (in/sec<sup>2</sup>) of the SFP floor from response spectrum analysis and vertical ISRS as input (1.0g PGA and 5-percent damping)

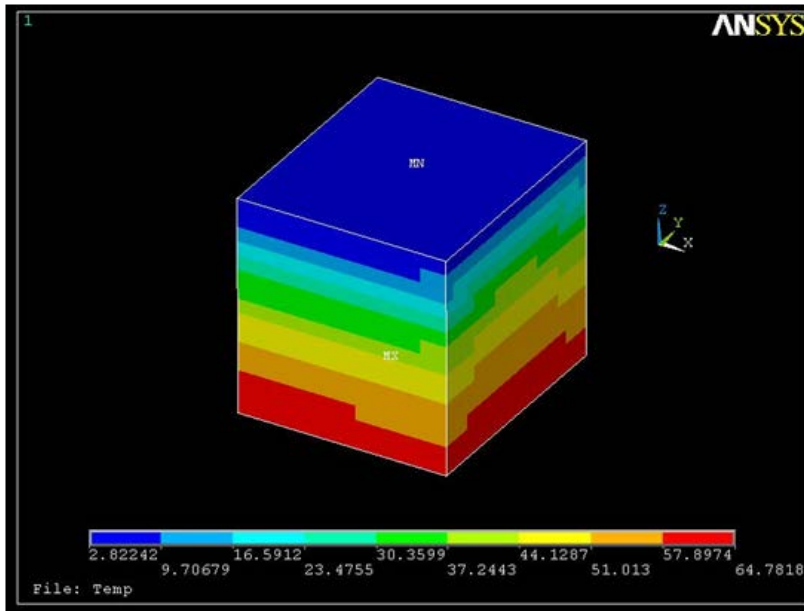


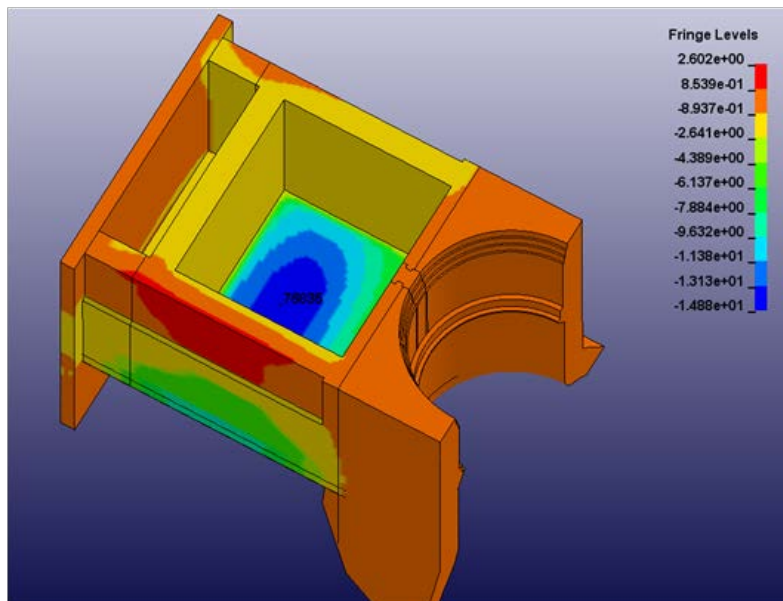
Figure 21 Estimated peak hydrodynamic pressures (psi) on the SFP floor from response spectrum analysis and vertical ISRS as input (1.0g PGA and 5-percent damping)

#### 4.1.4 Finite Element Analysis Results for the Spent Fuel Pool

This section presents a summary of the results obtained with the nonlinear finite element model described in the previous section for the loads described in Step 5 of the approach and estimated in Section 4.1.3. The principal objective of the analysis was to track the deformation of the SFP structure, concrete cracking and liner strains to estimate potential leakage rates.

The analysis used the LS-DYNA software which is an explicit dynamic finite element code. Since this is an equivalent static analysis, the analysis used mass scaling (with only minor changes in total mass of the model) together with slow ramping of the loads in order to minimize spurious dynamic effects. Specifically, the analysis slowly (with respect to the periods of vibration of the SFP structure) and proportionally incremented all dead loads until they reached their full values. Subsequently, the analysis slowly and proportionally applied all the equivalent seismic static loads until they reached their full values. Full values of the peak seismic loads were kept constant for some time in order to verify the stability of the response.

Figure 22 shows vertical displacement contours for the load combination consisting of the dead loads, 100-percent of the vertical seismic loads and 40-percent of all horizontal seismic loads. The maximum displacements are near the center of the SFP floor and are small on the order of 0.6 in. (15 mm) or about  $0.6/(40 \times 12) = 1/800$  of the clear span. Small displacements are a result of the high stiffness of the SFP structure which consists of thick RC slabs and walls (on the order of 6 ft) and comparatively short spans (from about 35 ft in the N-S direction and about 40 ft in the E-W direction).



**Figure 22 Contours of vertical displacements (mm) of the SFP floor and walls**

Figure 23 shows vertical displacement along the outside face of the W wall. Of special interest in Figure 23 are the discontinuities of vertical displacement at the bottom of the SFP wall at the top of the SFP floor, which are identified by the transition between the blue and green contours near the center of span at the bottom of the wall. Discontinuities of vertical displacements in this region are of interest because this is the region of possible strain concentrations in the SFP liner as shown in Figure 24. Finally, Figure 25 shows (with the red contour) the region of the SFP, at the bottom of the SFP walls and at the top of the SFP floor where the tensile strain of the concrete is exceeded and a crack could likely develop. The crack would start as a flexure crack and develop into a mostly tension-flexure crack though the thickness of the wall accompanied by shear friction at the bottom of the wall.

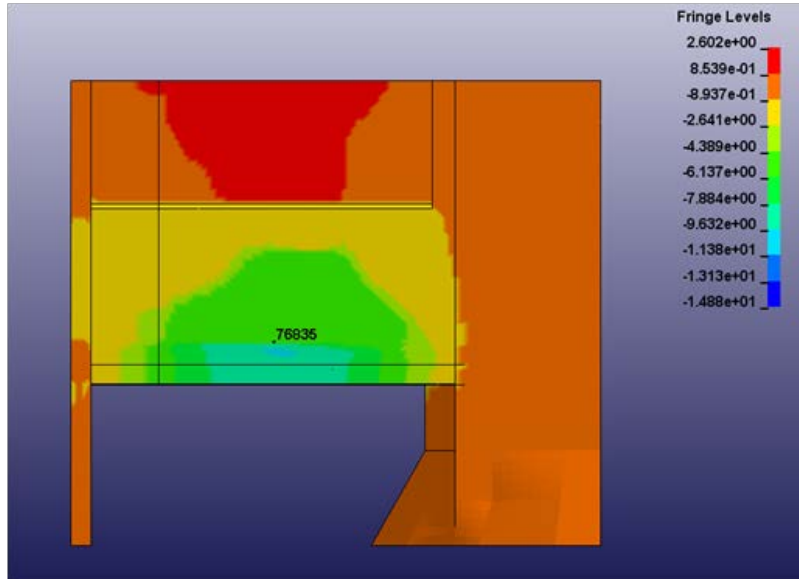


Figure 23 Contours of vertical displacement (mm) of the SFP walls

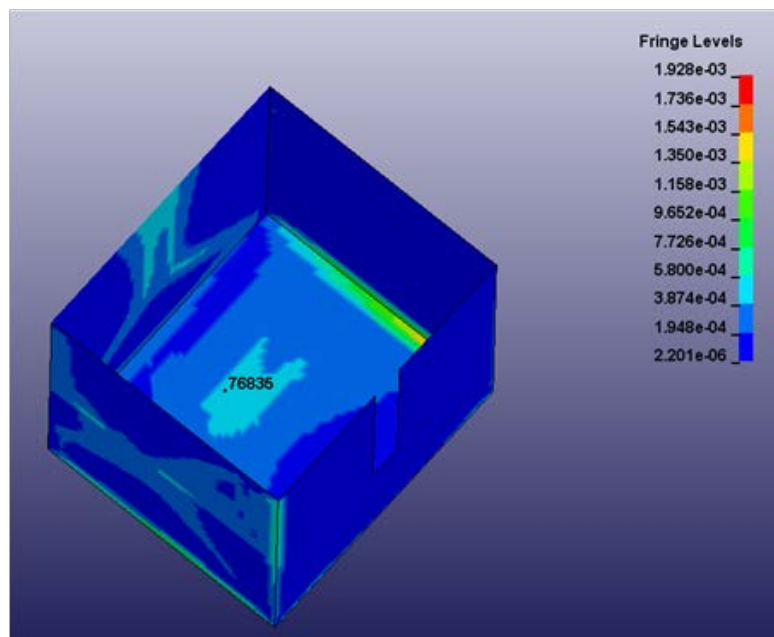
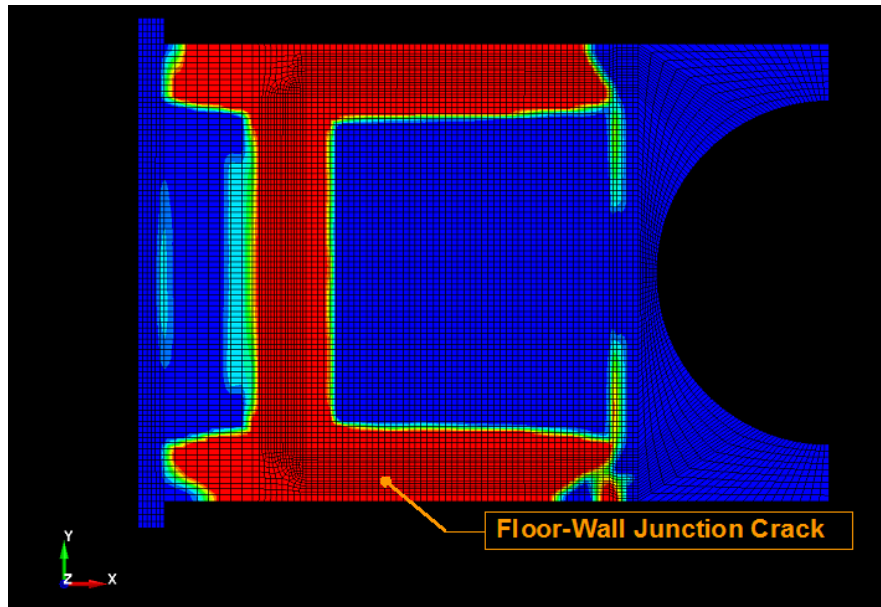


Figure 24 Liner strains (overall response not fully accounting for strain concentrations)



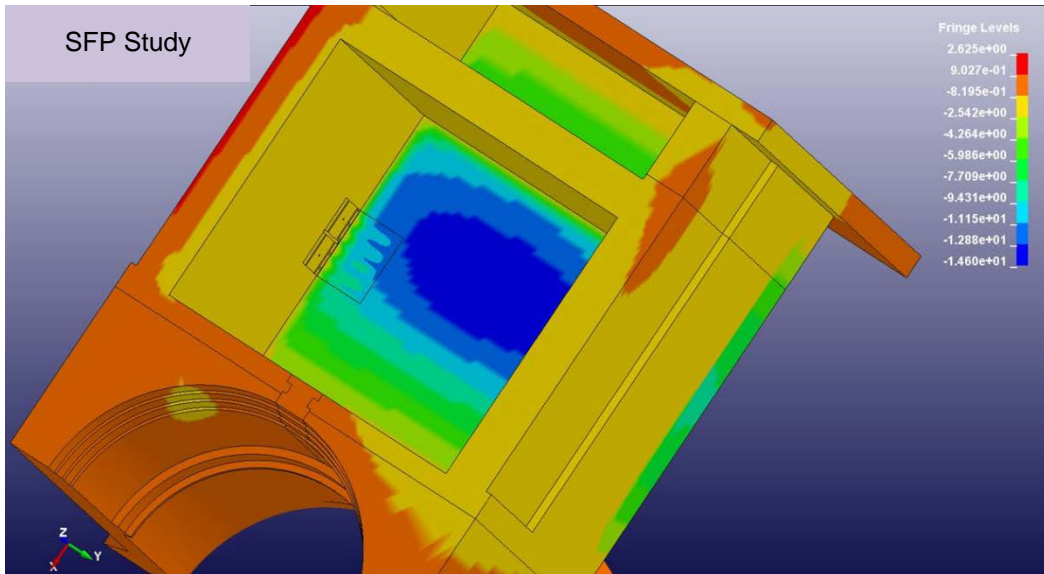


**Figure 25 Region of concrete cracking initiation at the floor-wall junction**

The higher liner strains in Figure 24 are, as expected, at the intersection of the SFP wall with the SFP floor, which is the region of strain concentrations. Although this is a region of strain concentrations, the liner strains shown are small, of the order of  $5 \times 10^{-4}$  to  $1.9 \times 10^{-3}$ . For comparison, the nominal liner yield strain is  $1.2 \times 10^{-3}$ . The mesh size for the liner for this overall finite element analysis is not sufficiently small to fully capture strain concentrations in the liner. The main objective of this analysis was to obtain the overall deformation of the structure and the development of concrete cracking which is not expected to depend significantly on the details of the liner modeling.

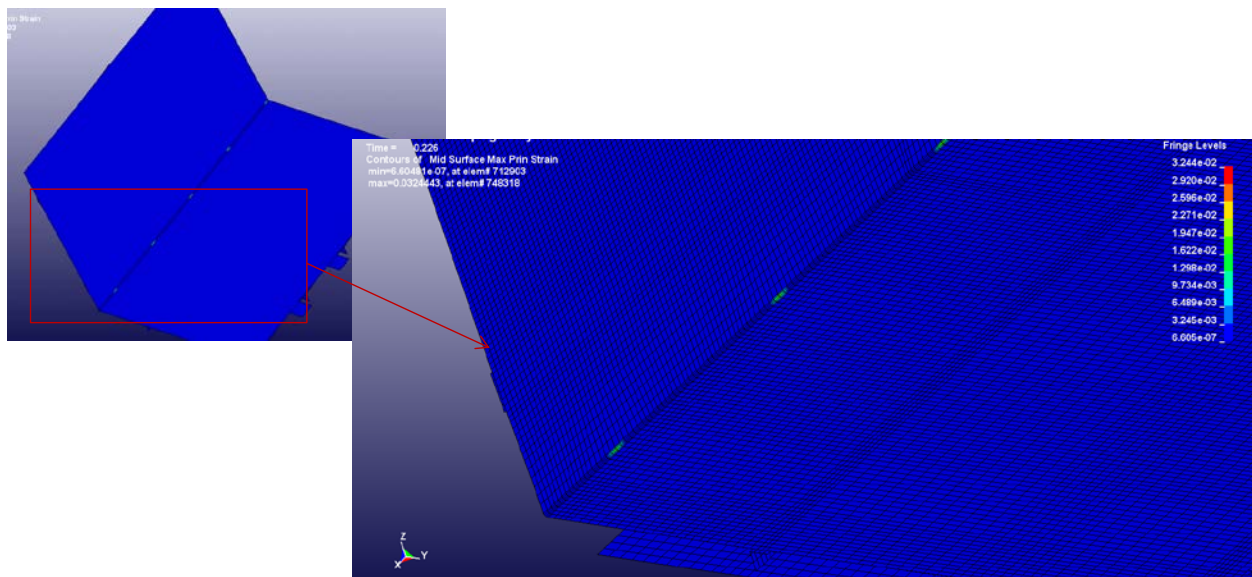
To assess strain concentrations in the liner, a detailed finite element model of the liner which includes the main details of its attachments to the floor and wall concrete was developed and is shown in Figure 18. The fine mesh of this liner inset uses elements as small as 0.15 in. (about 3.7 mm) at the transition from the floor to the wall. The analysis used this detailed liner insert to estimate the liner strains. Specifically, the detailed insert was embedded into the original nonlinear finite element model of the structure. The SFP structure was then analyzed with the embedded detailed model of the liner (using the “Constrained\_Lagrange\_in\_Solid” option in LS-DYNA and appropriate contact definitions) to assess strain concentrations in the liner. Note that the actual liner and the liner in the model are attached to the concrete only at a few discrete locations. Elsewhere, the liner is only in contact with the concrete. Specifically, at the junction with the wall, the liner is attached to concrete only near the backup plates between the floor and wall (see Figure 18) and is in contact with the concrete elsewhere along the floor-wall junction. For this reason, high strain concentrations are expected to develop only near the backup plates.

Figure 26 shows results of the analysis of the SFP with the embedded liner in a portion of the wall near the region where strain concentrations are expected to be the largest. The results show that the presence of the embedded liner as a gage does not affect the overall response of the SFP in a significant manner. However, it permits an estimation of the strain concentrations in the liner.



**Figure 26 SFP displacements (mm) with detailed liner insert**

Figure 27 shows the strain concentrations in the liner calculated using the detailed liner insert as indicated above. As expected strain concentrations are localized to the region of the liner near the backup plates, i.e., where the liner is attached to the shapes embedded in the SFP floor. Elsewhere the liner strains remain small as indicated by the overall analysis with the coarser model. The maximum membrane effective strain in Figure 27 is about 3.7 percent (0.037). The following section uses these strains as well as estimates of the width and extent of the concrete cracking (see Figure 25), to assess liner tearing likelihoods for the scenario considered.



**Figure 27 Strain concentrations in the SFP liner**

#### 4.1.5 Damage States

This section documents the results for Steps 6 to 9 of the approach defined in Section 4.1.1, which uses results from the nonlinear finite element analysis described in Section 4.1.4 to estimate leakage rates. These leakage rates are then used in the accident progression analysis to define the rate of loss of water from leakage at the bottom of the SFP. The section starts with the approach used to estimate the likelihood for each damage state for the initiating seismic event considered. Then, the section provides the estimation of the leakage rates for the damage states with leakage.

##### Damage States and Relative Likelihoods

Step 6 of the approach (Section 4.1.1) defined three initial damage states as follows:

- a. No leakage: A state with no leakage from the bottom of the pool. This state corresponds to concrete cracking at the base of the walls (estimated to be through-wall cracking for the event considered as shown in previous subsections) but without tearing of the liner.
- b. Moderate leakage rate: A state with leakage from the bottom of the SFP, corresponding to through-wall concrete cracking at the bottom of the walls and tearing of the liner that propagates to an extent such that water leakage is controlled by the size of the cracks in the concrete.
- c. Small leakage rate: A state with leakage from the bottom of the SFP, corresponding to through-wall concrete cracking at the bottom of the walls and tearing of the liner that remains localized to the where the floor liner is attached to the SFP floor near the walls.

This study uses an approach and strain criteria, including uncertainties, for tearing of steel liners in reinforced concrete containments (Cherry, 2001 and 1996) together with uncertainties in the calculated liner strains to estimate the relative likelihoods for the three initial damage states listed. Uncertainties in the calculated liner strains account for (1) uncertainties in the ISRS spectral accelerations (of the order of 25 percent), (2) uncertainties in liner strains from uncertainties in concrete properties (namely concrete strength) and (3) an additional reduction in spectral accelerations to account for both ground motion incoherency and nonlinear effects.

The analysis used information in Cherry (1996) to estimate upper and lower bounds for the limiting failure strain, which were then used with a triangular probability density function to estimate their mean and coefficient of variation (Ang, 1984). This is expected to be a conservative assumption in that the SFP liner is of stainless steel which is likely to have larger limiting failure strains. This approach, adjusts the failure strain from coupon tests using reduction factors that account for the multi-dimensional state of stress (triaxiality effects), uncertainties in material properties, and the level of detail in the analysis used to estimate strain concentrations. Bounds in the liner limiting failure strain use a failure strain from coupon tests of 21-percent (0.21) together with a triaxiality factor of 1.75 (typical of a cylindrical state of stress). Estimation of these bounds considers a high level of detail in the model for the calculation of strain concentrations which used elements as small as 0.15 in (3.7 mm) wide. Accordingly, this study considered a range of reduction factors for the analysis detail that range from 0.4 to 0.9. Reduction factors for material properties were those reported in Cherry (1996). On these bases, the bounds on the failure strain for the purposes of estimating its mean and coefficient of

variation came to be 0.045 and 0.14, and the resulting mean and coefficient of variation came out to be 0.09 and 0.20, respectively.

Maximum effective tensile strains in the liner were calculated assuming reduced material properties and were found to be sensitive to the concrete strength. Effective strains calculated for the median concrete strength and a reduced concrete strength were used to assess the derivative of this strain to the concrete strength. This derivative was then multiplied by the standard deviation of the concrete strength which was calculated using an estimated coefficient of variation for the concrete strength of 0.15 (Lambright et al., 1990) to estimate the standard deviation and coefficient of variation of the liner strain associated with uncertainties in the concrete strength. This coefficient of variation was estimated to be about 0.65.

Maximum effective concrete strains calculated for the 0.7 g PGA and for reduced seismic loads (about 70-percent of the initial loads) were used to estimate the sensitivity of the effective strain to the estimated spectral amplitudes. Nonlinear analyses were done to estimate maximum effective strains for spectral accelerations equal to about 80-percent of the original to account for effects of ground motion incoherency and further reductions from nonlinear effects. Additional uncertainty measures for the calculated strain were then estimated using the calculated strains for the base case and the case with reduced spectral amplitudes in conjunction with an asymmetric triangular distribution for the calculated strains. The assumed triangular distribution used the strain for the reduced value as the least likely value and that for the base case as the most likely value. This procedure resulted in an adjustment of the median strain (reduction factor equal to 0.93) and an additional coefficient of variation (0.09) for the liner strain. An additional coefficient of variation for the ultimate strain of about 0.25 was used to account for uncertainties in the estimate of floor response spectra ordinates (Lambright et al., 1989).

Uncertainties calculated in this manner were then used to estimate medians and coefficients of variation for the limiting failure strain (capacity) and for the induced strain (demand). Using these quantities and assuming lognormal distributions, the probability of liner tearing conditional on the occurrence of the seismic event was estimated to be less than 10-percent (Ang, 2006; Ang, 1984). This estimate indicates that the state with no leakage (no tearing of the liner) is the most likely with a relative likelihood in excess of 90-percent. The relative likelihood of the two states with leakage from the bottom of the SFP is estimated at less than 10-percent. Assigning relative likelihoods to the two damage states with leakage is subject to considerable uncertainties at this time. Accordingly, the assumption is made that both states are equally unlikely.

#### Concrete Cracking and Moderate Leakage Rate

Postprocessing of the displacements at the top of bottom nodes of the horizontal layer of concrete finite elements at the top of the SFP floor provides an estimate of the width and length of the cracking at the bottom of the SFP walls. The first step of this processing is the sampling of vertical displacements at the top and bottom nodes of this layer of concrete elements at various locations along the perimeter and through the depth of the wall. This is achieved by dividing the length of the base of the wall into segments and sampling those quantities at locations across the wall thickness near the center of each segment. The next step consists of subtracting the displacements of the top and bottom nodes for a first estimate of the crack width at the sampled locations. This estimate is then corrected by subtracting the vertical displacement of those nodes implied by the tensile strain of the concrete at cracking, which is comparatively small. A main assumption in this process is that a major single concrete crack

(flexure-tension crack for this SFP) develops at the floor-wall junction rather than a set of closely spaced minor cracks. The next step averages the sampled crack widths through the thickness of the walls for each sampled segment at the base of the walls. Finally, the processing combines the crack areas estimated in this manner to estimate an average crack width of about 3.6 mm (about 0.14 in.) and an average crack length of about 33,000 mm (about 108 ft), with a non-smooth and non-uniform surface. An average crack width is used because the overall change in the crack width is not expected to be large along the perimeter of the floor.

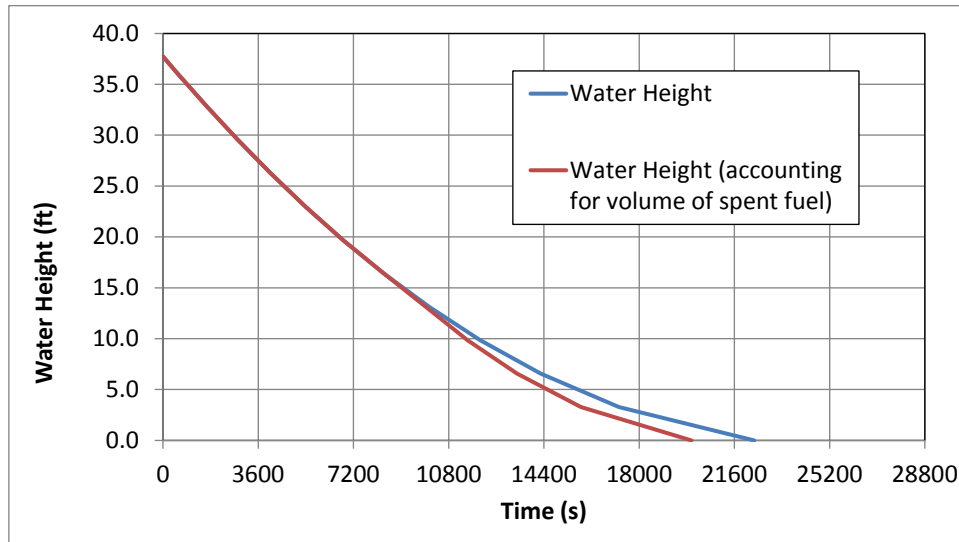
Estimation of the flow through this crack used recent experimental data for the flow of water through thick cracked concrete sections for hydraulic pressures similar to those in the SFP (Kanitkar et al., 2011). Crack widths and water pressures for those tests envelope the average crack width estimated for the SFP and the water pressures in the SFP. The thickness of the concrete slabs is about half of the thickness of the SFP walls, meaning that these are large scale tests. Main results of that testing are (1) an equation to estimate the leakage flow rate through concrete cracks that involves a friction factor and (2) quantification of that friction factor based on the experimental data. Specifically, the study recommends the use of the following equation derived from the Navier-Stokes equations for incompressible flow of a Newtonian fluid:

$$\frac{P}{\rho g} = \frac{v^2}{2g} + f \frac{v^2}{2g} \frac{d}{2w}$$

where  $P$  is the pressure,  $\rho$  is the fluid density,  $g$  is the acceleration of gravity,  $v$  is the flow velocity,  $d$  is the crack depth (concrete thickness), and  $f$  is a friction factor. The results reported indicate that a friction factor of 0.8 is adequate for the average crack width estimated above.

Using the equation above for the leakage flow, and a friction factor of 0.8, assuming no initial loss of water and using the crack width and length estimated above, the leakage flow was calculated as shown in Figure 28 in terms of the change of the water height in the SFP with time. The flow rate in that figure represents a moderate flow rate condition. The average flow rate for this condition to a height of about 16 ft above the SFP floor is about 1,500 gallons per minute.

For this condition to occur it is necessary that the liner strains exceed failure strains for the liner material at the region of strain concentrations (near the backup plates), that these tears become unstable and that the liner tearing spreads to an extent such that the leakage rate through the liner is greater than the leakage rate through the concrete cracks. In this case, concrete cracking controls the leakage rate from the SFP. This is further discussed below in conjunction with the liner strains and liner failure criteria as well as the estimation of the relative likelihoods for the three damage states considered.



**Figure 28 Moderate leakage flow rate (through concrete cracks)**

### Liner Strains and Small Leakage Rates

Maximum effective membrane liner strains from strain concentrations at the floor-walls junction are on the order of 0.037 (3.7 percent). These strains are localized at the backup plates, which are spaced 24 in (609.6 mm) apart along the length of the E and W walls. Attachment details along the S wall are different, imposing less compliance of the liner to the concrete deformations, and are not expected to lead to strain concentrations as large as those at the base of the E and W walls. In addition, liner strains near the biological concrete shielding are smaller. Moreover, liner tearing or through wall (or floor) concrete cracking are not expected near the biological concrete shielding. Accordingly, tearing of the liner, if it were to occur, would be only along the base of the E and W walls.

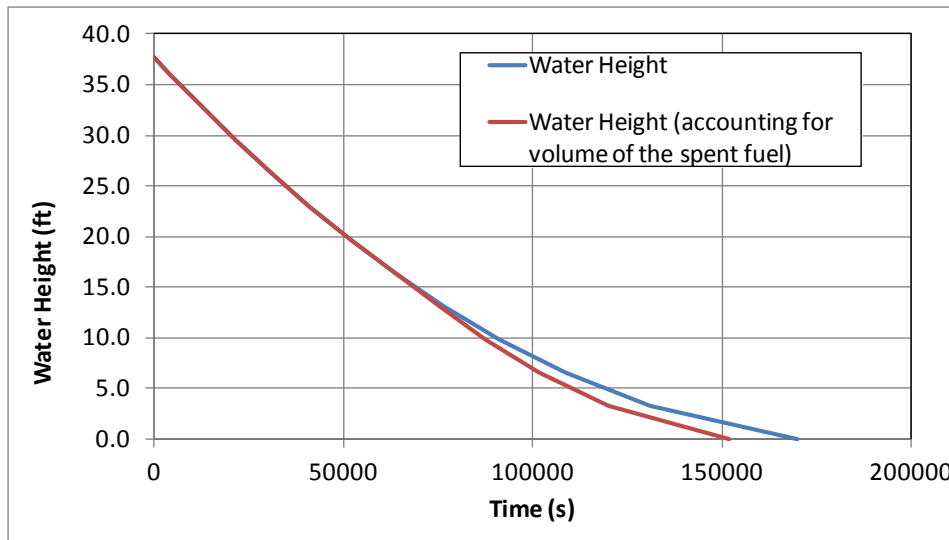
An approach and failure criteria for steel liners used in reinforced concrete containments is used here to assess tearing of the SFP liner (Cherry, 2001 and 1996). Failure criteria for liners without corrosion damage reported by Cherry (1996) are used in this study to estimate limiting failure strains for the stainless steel SFP liner. The approach estimates the crack width by multiplying the liner strain at failure by the width of the finite element with the maximum induced effective strain, which is approximately equal to 0.15 in (3.7 mm) as indicated above.

Since both the induced strains (demands) and failure strains (capacity) are treated as random variables, the strain at which the liner would tear, that is the condition at which the induced strain exceeds the limiting failure strain, is also random. An approach for a point estimate of that strain would be to calculate the most likely failure strain, which would be a strain greater than the estimated median induced strain (demand) of 0.37 but likely less than the median limiting failure strain (capacity) of about 0.10. Such an approach would involve a more detailed uncertainty analysis and probabilistic modeling than that used in this study, which does not seem justified given the approximations used as well as the uncertainties involved in the assessment of the flow rates through tears in the liner. This study assumed a failure strain of 0.10 (10 percent) for the liner strain at failure, which is approximately equal to the assumed median failure strain.

The resulting crack width for a liner tear localized at the location of the backup bar is then estimated at  $0.15 \times 0.10 = 0.015$  in (0.37 mm). The crack length at each location is taken to be equal to the width of a backup bar which is equal to 4.0 in (101.6 mm). Given that the spacing of the backup bars is 24 in (609.6 mm), a total of 40 backup bars (20 on each wall) are used to estimate the summed length of all localized cracks as  $40 \times 4 = 160$  in (4,064 mm). The estimated width for each crack, if it were to occur, is then 0.015 in (0.37 mm) and the depth of the crack is the depth of the liner which is equal to 0.25 in (6.35 mm).

Given the estimated width, length and depth for each localized liner tear and their number, it is still necessary to estimate the leakage rate through these tears. Estimation of this flow rate uses the following assumptions (1) the flow rate can be estimated using an equation similar to that used for flow through the concrete cracks and (2) the friction factor for that equation can be calculated on the basis of test results for leakage rates through cracks in pipes. These assumptions are not validated at this time. Therefore, considerable uncertainty exists for the resulting leakage rate estimate. The following paragraph addresses the process used to estimate the flow rate through these liner tears as well as sources of uncertainty for this estimation. These uncertainties may result in flow rate estimates that can vary by more than 100%. This damage state (small leakage rate) already is a result of binning the uncertain liner tearing into two discrete tearing conditions to cover a range of uncertainty for liner damage and associated flow rates. Assigning equal likelihood to the two highly distinct damage states acknowledges these uncertainties.

Estimation of a friction factor was made using data in Paul et al. (1994) for leakage through cracks in steel pipes. Back calculation of friction factors from data presented in this reference shows a large variability in the calculated friction factor. In particular, the friction factor appears to depend heavily on the smoothness of the crack surface. Also, the fluid in the pipe is at high temperatures and the driving pressures are much higher than those applicable to the SFP. Review of other flow models reported in Paul et al. (1994) indicates that for relatively smooth cracks friction will be low. Assuming relatively smooth cracks, the equation for the flow through concrete cracks was applied for flow through steel tears together with a small friction factor (0.11) in order to estimate the leakage flow rates. For this friction factor, the estimated leakage flow through the steel cracks (small leakage flow) is as shown in Figure 29. Considerable uncertainty continues to exist in the estimation of leakage flow rates for these localized liner tears. Given the assumption that the crack surface is relatively smooth, it is estimated that the flow rates in Figure 29 would be greater than the actual flow rates. The average flow rate for this condition to a height of about 16 ft (488 mm) above the SFP floor is about 200 gallons per minute (757 liters per minute).



**Figure 29 Small leakage flow rate (through localized steel tears)**

#### **4.2 Other Damage States**

Assessment of other damage stages is primarily based on (1) finite element deterministic response spectra analysis to estimate maximum vertical displacements of the water surface (sloshing), (2) seismic fragilities used in conjunction with the NUREG-1150 seismic PRA study (Lambright et al., 1990), (3) the examination of design details for certain appurtenances such as the refueling gate, and (4) maximum displacements (vertical and horizontal) of the SFP floors and walls under the applied loads.

##### Loss of Water from Sloshing

Vertical displacements of the water surface (sloshing) that may lead to the ejection of some water from the SFP depend on the low frequency components of the motions at the base of the SFP. Finite element analysis using the ANSYS finite element model described above, show that the natural frequencies of the sloshing modes in the two horizontal directions parallel to the walls of the SFP are about 0.27 Hz and 0.29 Hz, corresponding to periods of vibration on the order of about 3.8 to 3.5 seconds. These results resemble those obtained using analytical methods (e.g., AEC, 1963; Malhotra et al., 2000).

The free-field ground motion specified for the study does not have high spectral velocities and accelerations at the sloshing frequencies. Consequently, sloshing amplitudes are expected to be small. Deterministic response spectrum analyses with the simplified ANSYS finite element model of the SFP using the horizontal ISRS at midheight of the SFP (for the frequencies of interest to sloshing) as input and considering the low damping of the sloshing mode, show that the sloshing amplitude will not exceed about 20 in. Given that the water at the pool is about 1 ft below the top of the SFP, sloshing is not expected to cause more than 1 ft of water loss. Accordingly, an initial 1.5 ft decrease in the height of the water is considered at the end of the earthquake event for the subsequent accident progression analysis.



## Damage to Refuel Gate, SFP Penetrations, Spent Fuel Assemblies and Racks

*Refuel gate:* A site visit and examination of the refueling gate structural drawings revealed the following:

- The steel gate next to the water is backed by a similar gate.
- Each of these gates consists of a steel-plated decking with steel stiffeners.
- Each gate has a polymeric seal around its perimeter that is pressed against the concrete by passive mechanical means that are not expected to be lost during the seismic event. Since these are passive mechanical means the effectiveness of the seals does not depend on the availability of ac or dc power.
- Tolerances around the seals are sufficient to accommodate the already small distortions of the biological concrete shielding in the refueling area from the seismic event.

Based on the above, the study assumes that the refueling gate will not fail for the seismic event considered and will continue to maintain its intended function during the accident progression.

*SFP penetrations:* According to the FSAR, there are no connections to the SFP that would allow water to drain below the refueling gate or below 10 ft above the top of active fuel. The FSAR further states that lines below the levels in the previous paragraph are equipped with siphon breaker holes to prevent inadvertent drainage. In addition, the systems for maintaining water quality and quantity are designed so that failure or inappropriate operation of these systems does not cause uncovering of the fuel. Results of the nonlinear finite element analysis also indicate that overall distortions of the pool walls are small (on the order of a few millimeters). These distortions are not expected to lead to seismically induced damage of the penetrations that would lead to potential leakage.

*Spent fuel racks and assemblies:* Damage to the spent fuel assemblies and racks was not calculated as part of this study. The study assumes that under the applied seismic loads a coolable configuration would be maintained. This assumption is consistent with the seismic assessments made in conjunction with the resolution of GI-82 and reported in NUREG/CR-5176 (Prassinis et al., 1989). As in the case considered in GI-82, the spent fuel racks for the site considered are allowed to slide, which tends to reduce the magnitude of the seismic accelerations on the racks and partially decouple their dynamic response from the response of the SFP. In addition, the high-frequency components (greater than 10 Hz) of the motion would not be expected to induce large sliding or rocking motions.

## Damage to the Reactor Building and Other Relevant SSCs

According to the fragility analysis for the NUREG-1150 seismic PRA (Lambright et al., 1990), the median fragility for the reactor building is about 1.6g. The response of the reactor building structure is expected to be more sensitive to the horizontal ground motions than to the vertical ground motions. Natural frequencies of vibration for horizontal modes of vibration of the reactor building are about 7 Hz (i.e., frequencies at which the spectral accelerations of the ground motion for the scenario considered are less than those for the ground motions with the same PGA considered in earlier evaluations of the median fragility). On these bases, seismically-induced failure or severe damage to the reactor building would not be expected for the seismic scenario considered.

Examination of structural drawings for the Peach Bottom reactor buildings together with a simple kinematic analysis indicates that if the crane bridge were to lose support at one of its ends as a consequence of the ground shaking, that end of the crane bridge would not fall inside the SFP. Depending on the end of the crane bridge losing support, the crane could fall only a few feet from the SFP, but not inside the SFP.

A LOOP is expected for the seismic scenario considered. Median fragilities for loss of offsite power, in terms of PGA, are less than half the PGA for the seismic motion considered in this study. Review of the fragilities estimated for NUREG-1150 study (Lambright et al., 1990) indicates a high probability of loss of onsite ac power (about 0.84). This estimate is based on either direct failure of the onsite emergency diesel generators (assumed to be sensitive to spectral accelerations around the 20 Hz frequency) or failure of either the emergency service water or the emergency cooling water systems that provide cooling water for the diesel generators. The probability of losing dc power based on the fragility of the inverters alone is estimated to be close to but less than 50-percent for the seismic event considered in this study.

#### **4.3 Review of Spent Fuel Pool Performance under Recent Major Earthquakes in Japan**

Five Japanese nuclear power plant sites with a combined total of 20 reactors and 20 SFPs were subjected to severe ground motions from two major earthquakes in the past 5 years (NERH, 2011a; NERH, 2011b; Kawamura, 2008; Sato, 2010):

- March 11, 2011, Tohoku earthquake (with moment magnitude  $M_w = 9.0$ )
  - Fukushima Daiichi (5 BWR Mark I and 1 BWR Mark II SFPs)
  - Onagawa (3 BWR SFPs)
  - Fukushima Daiini (4 BWR SFPs)
  - Tokai (1 BWR SFP)
- July 16, 2007, Niigataken Chuetsu-Oki earthquake ( $M_w = 6.6$ )
  - Kashiwazaki-Kariwa (7 BWR SFPs)

This review addresses reductions in water levels for the SFPs affected by those events that might have resulted from either water leakage from structural damage or water loss from sloshing, if any.

No leakage of water near the bottom of the SFPs has been reported for any of the 20 SFPs in those five nuclear power plants for these two major earthquakes. For the Kashiwazaki-Kariwa site, the only report of water loss (leakage or sloshing) for the seven SFPs at the site was a loss of about 320 gallons (about 1.2 cubic meters) from sloshing of the water in the SFP of Unit 6 (Kawamura, 2008).

Loss of water other than from sloshing was not reported for the SFPs of the power plants affected by the March 11, 2011 Tohoku earthquake (NERH, 2011b). According to the NERH (2011b) report, minor leaks of radioactive material (all contained inside buildings) at the Onagawa plant were attributed to sloshing of SFP water, and SFP sloshing overflow lead to a 8 in (20 cm) decrease of the water level in the SFP at Tokai. Actual decreases in SFP water levels from sloshing at the Fukushima Daiichi units are not known, but decreases in water level from sloshing have been assumed in evaluations of SFP performance (NERH, 2011b). Specifically, a

water level reduction of about 1.6 ft (0.5 m) was assumed for Unit 2 as a result of sloshing induced by the ground motion while reductions of about 5 ft (1.5 m) were assumed for Units 1, 3 and 4 from sloshing associated with ground motions and explosions.

This review also provides a comparison of ground motion indices and ISRS spectral accelerations considered for this study and observed at the various units of those nuclear power plants. Although this review and comparison use information available at the time of the execution of this study, they assist in the interpretation of the results obtained for the seismic scenario and SFP considered in this study.

It is noted that the seismic design loads for the various reactors considered in this comparison differ, for the most part, from the design basis loads for the site considered in the SFP Study. A possible exception to this would be Unit 1 at Fukushima Daiichi, which initially considered comparable seismic design-basis loads. However, seismic design basis loads for this reactor were subsequently revised upwards (those are the design loads reported in this comparison). Differences in the seismic design-basis loads and uncertainties regarding the construction details (e.g., out of plane shear reinforcement if any) for the various SFPs listed above add to the overall level of uncertainty in the comparisons. However, this section provides a comparison of the structure of the SFP considered in this study and the structure for the SFP of Fukushima Daiichi Unit 4, for which some structural information was available at the time of the writing of this report.

Another source of uncertainty for this comparison is that the recorded ground motions and related PGAs at the various sites are not, for the most part, free-field ground motions and, therefore, are not directly comparable to the free-field PGA considered in the study. However, the free-field ground motion for this study is also taken to be the foundation ground motion because the reactor building is considered to be a fixed-base structure. Additional sources of uncertainty are the type of reactor (several of the plants have Mark II containments instead of Mark I containments), site conditions (soil versus rock sites), reactor building foundation (slab thickness and uniformity) and reactor building embedment. Generally, the foundation slabs for the reactors listed above are thicker and more uniform than that for the reactor considered in the study. Also, the site for the study is a rock site and stiffer than the sites for Fukushima Daiichi and Kashiwazaki-Kariwa.

An additional source of uncertainty for the comparison is that ISRS reported for some plants may be affected by localized structural details such as the vertical response of a floor slab. Such ISRS would not be representative of the seismic loads on the SFP in the same sense as the ISRS used in this study. Precise determination of the location of the accelerometers used for the observed ISRS was not done for these review and comparison. Table 10 to Table 14 show horizontal and vertical PGAs observed at the foundation slab of the various units for each of the nuclear power plants. Those tables also list the design PGAs for each of the reactors. For comparison, the vertical and horizontal PGAs for the free-field ground motion considered in this study are about 0.7g. On the basis of the values reported on those tables, the following observations are possible:

- Horizontal PGAs at the foundation slabs of all reactors are less than those considered in the study with the exception of that for Kashiwazaki-Kariwa Unit 1.
- Vertical PGAs at the foundation slabs of all reactors are for the most part less than horizontal PGAs with the exception of Fukushima Daiichi Unit 1 and Kashiwazaki-Kariwa Units 6 and 7.

- Vertical PGAs at the foundation slabs of all reactors are less than those considered in the study.
- The difference between the recorded PGAs and the PGA for the study is greater for the vertical accelerations than for the horizontal accelerations.
  - The study assumes that the vertical PGA is approximately equal to the horizontal PGA (see Section 3.3).

**Table 10 Fukushima Daiichi, Measured and Design (DBGM S<sub>s</sub>) PGAs at Foundation Slab (Tohoku, 2011 Earthquake)**

Unit	Containment	Measured (cm/s <sup>2</sup> )			Design Values (cm/s <sup>2</sup> )		
		Horizontal		Vertical	Horizontal		Vertical
		NS	EW		NS	EW	
1	Mark I	460	447	258	487	489	412
2	Mark I	348	550	302	441	438	420
3	Mark I	322	507	231	449	441	429
4	Mark I	281	319	200	447	445	422
5	Mark I	311	548	256	452	452	427
6	Mark II	298	444	244	445	448	415

**Table 11 Onagawa, Measured and Design (DBGM S<sub>s</sub>) PGAs at Foundation Slab (Tohoku, 2011 Earthquake)**

Unit	Reactor	Measured (cm/s <sup>2</sup> )			Design Values (cm/s <sup>2</sup> )		
		Horizontal		Vertical	Horizontal		Vertical
		NS	EW		NS	EW	
1	BWR	540	587	439	532	529	451
2	BWR	607	461	389	594	572	490
3	BWR	573	458	321	512	497	476

**Table 12 Fukushima Daiini, Measured and Design (DBGM S<sub>s</sub>) PGAs at Foundation Slab (Tohoku, 2011 Earthquake)**

Unit	Reactor	Measured (cm/s <sup>2</sup> )			Design Values (cm/s <sup>2</sup> )		
		Horizontal		Vertical	Horizontal		Vertical
		NS	EW		NS	EW	
1	Mark II	254	230	305	434	434	512
2	Mark II	243	196	232	428	429	504
3	Mark II	277	216	208	428	430	504
4	Mark II	210	205	288	415	415	504

**Table 13 Tokai, Measured and Design (DBGM S<sub>s</sub>) PGAs at Foundation Slab (Tohoku, 2011 Earthquake)**

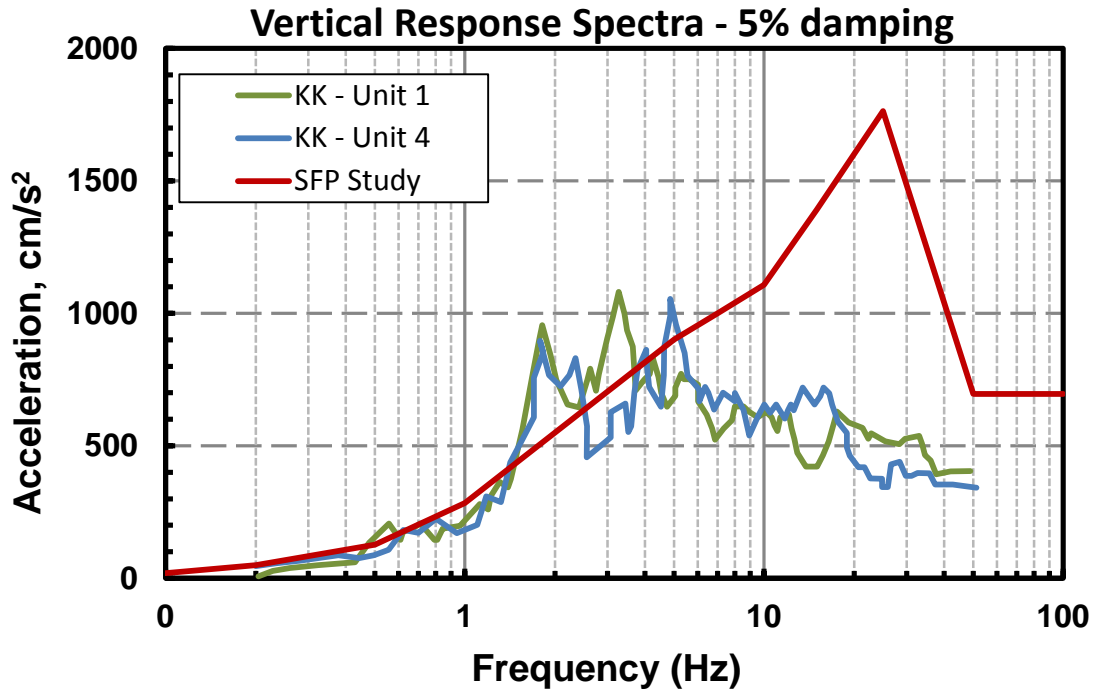
Unit	Reactor	Measured (cm/s <sup>2</sup> )			Design Values (cm/s <sup>2</sup> )		
		Horizontal		Vertical	Horizontal		Vertical
		NS	EW		NS	EW	
1	Mark II	214	215	189	393	400	456

**Table 14 Kashiwazaki-Kariwa, Measured and Design PGAs at Foundation Slab (Chuetsu-Oki, 2007 Earthquake)**

Unit	Reactor	Measured (cm/s <sup>2</sup> )			Design Values (cm/s <sup>2</sup> )		
		Horizontal		Vertical	Horizontal		Vertical
		NS	EW		NS	EW	
1	Mark II	311	680	408	274	273	235
2	Mark II	304	606	282	167	167	235
3	Mark II	308	384	311	192	193	235
4	Mark II	310	492	337	193	194	235
5	Mark II	277	442	205	249	254	235
6	ABWR	271	322	488	263	263	235
7	ABWR	267	356	355	263	263	235

Another aspect of interest for this comparison is the frequency content of the ground motions as characterized by response spectra. The site chosen for the study is a rock site and dominant seismic event for this scenario would be an earthquake in the CEUS at a distance of about 15 km or less. Accordingly, the ground motion response spectra for the seismic scenario considered has maximum spectral accelerations for frequencies greater than about 10 Hz and at frequencies near the lower fundamental frequencies of the spent fuel pool structures.

Figure 30 includes vertical response spectra for 5-percent damping at the foundation slab of Unit 1 (the case with a horizontal PGA of about 0.7g) and Unit 4 of Kashiwazaki-Kariwa together with the corresponding response spectrum for the vertical ground motion considered for the study. This comparison indicates that the ground motion for this study has higher vertical spectral accelerations near the lower fundamental frequencies of vibration of the SFP structure. Spectral accelerations for the ground motion used in the study remain higher than those for Unit 4 down to a frequency of about 5 Hz and those for Unit 1 down to frequencies of about 4 Hz. The results shown are typical of those for the other reactors at Kashiwazaki-Kariwa (with the possible exception of Unit 6 which has significantly higher spectral accelerations between 6 and 2.5 Hz). The reactors at this plant are Mark II reactors, have reinforced concrete base slabs several times thicker than the reactor considered in this study, and are deeply embedded in the ground.



**Figure 30 Vertical response spectra: Kashiwazaki-Kariwa Units 1 and 4 (foundation level) and SFP study (free-field)**

With the exception of Unit 4 at Fukushima Daiichi, vertical response spectra for the reactors affected by the March 11, 2011 Tohoku earthquake were not available at the time of the study, so the comparison of foundation response spectra are, for the most part, made using horizontal spectra. Figure 31 shows horizontal response spectra for 5-percent damping at the foundation slab of Unit 1 and Unit 4 of Fukushima-Daiichi and the corresponding response spectrum for the horizontal ground motion used in the study. Comparison of those spectra indicates that the ground motion for this study (rock site) has higher horizontal spectral accelerations at the lower natural frequencies of the SFP structure (about 0.05 seconds). Spectral accelerations for the ground motion used in the study remain higher than those for Unit 1 for frequencies down to about 4 Hz and those for Unit 4 for frequencies down to about 3 Hz. The results shown are, in general, typical of those for the other reactors at Fukushima Daiichi.

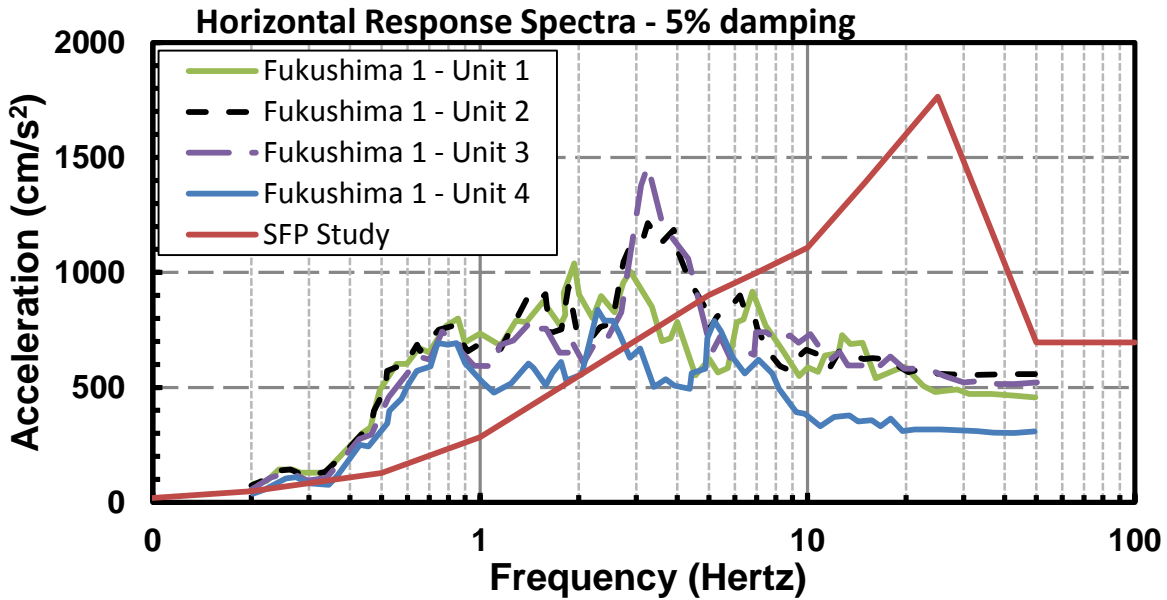


Figure 31 Horizontal response spectra: Fukushima Daiichi Units 1 and 4 (foundation) and SFP study (free-field)

Figure 32 shows vertical response spectra for 5-percent damping at the foundation slab of Unit 4 of Fukushima-Daiichi and the corresponding response spectrum for the vertical ground motion used in the study. Comparison of those spectra indicates that the ground motion for this study (rock site) has higher horizontal spectral accelerations at the lower natural frequencies of the SFP structure (about 0.05 seconds). Spectral accelerations for the ground motion used in the study remain higher than those for Unit 4 for frequencies down to about 3.5 Hz.

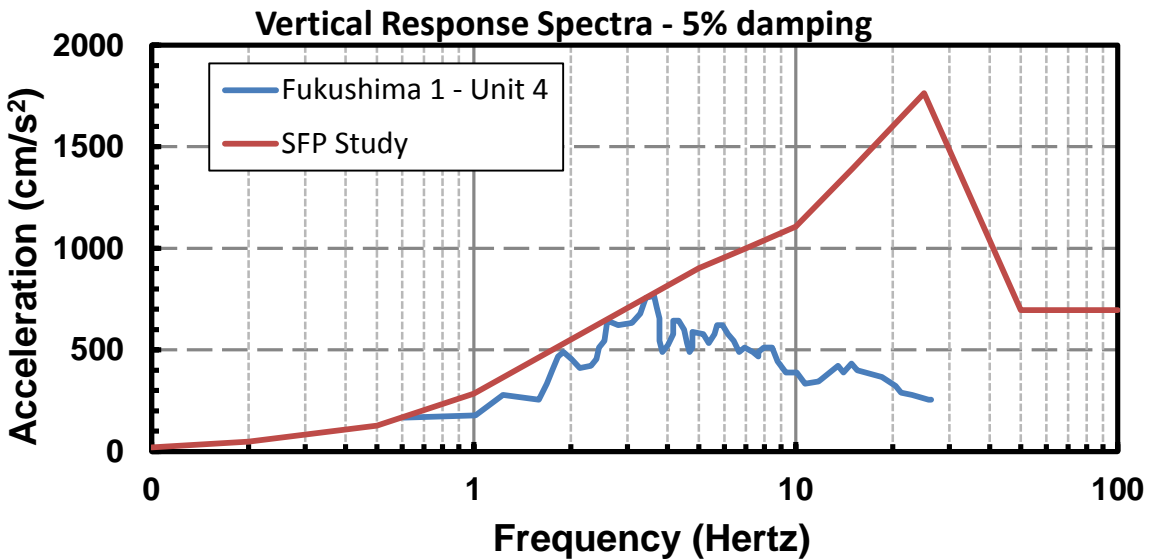
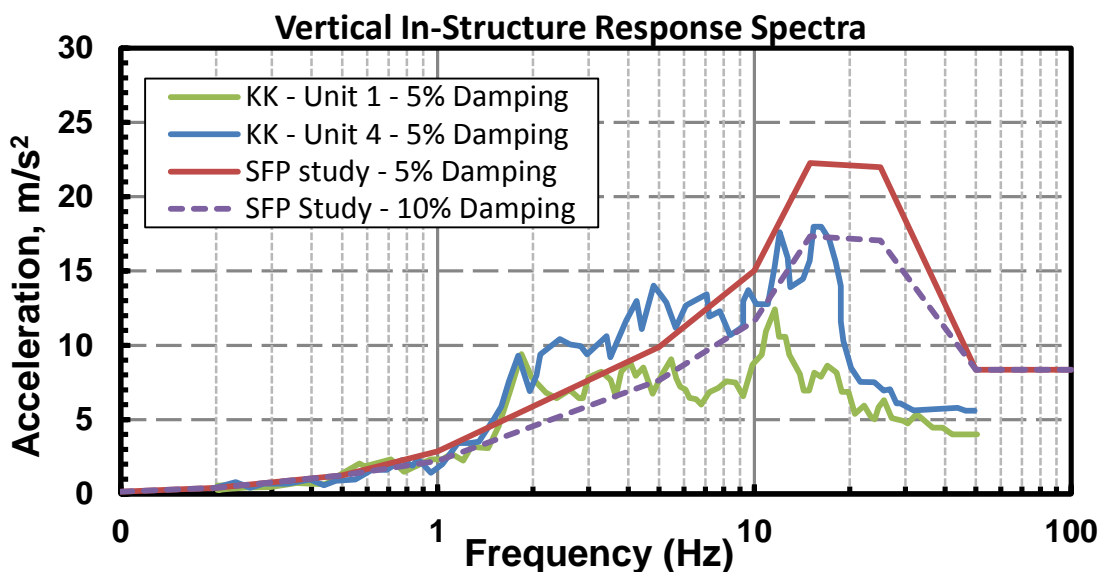


Figure 32 Vertical response spectra: Fukushima Daiichi Unit 4 (foundation) and SFP study (free-field)

Figure 33 shows vertical ISRS at an elevation at about midheight of the SFP for Unit 1 and Unit 4 of Kashiwazaki-Kariwa together with the vertical ISRS for the study. ISRS for the study are shown for 5-percent and 10-percent damping. In both cases, the ISRS for the study is higher than the observed ISRS for frequencies close to the lower natural frequencies of the SFP considered in the study. The 5-percent ISRS for this study remains above that for Unit 4 down to frequencies of about 12 Hz and approximately equal to it for frequencies down to about 7 Hz. The 5-percent ISRS for this study remains higher than that for Unit 1 for frequencies down to about 4 Hz.

The 10-percent damping ISRS for the reactor building approaches that of Unit 4 at frequencies equal to about 17 Hz. The 10-percent ISRS for this study is higher than that for Unit 1 for frequencies down to about 6 Hz and is close to it at about 12 Hz. The ISRS for Unit 1 is typical of those for the other units with the exception of Unit 3, which approaches the 5-percent damping ISRS for the study at about 11 Hz.



**Figure 33 Vertical ISRS for Kashiwazaki-Kariwa Units 1 and 4 and for the SFP Study**

The comparisons, especially the comparison of the vertical response spectra at the foundation of Unit 4 of Fukushima Daiichi and at the base of the SFP for the study, indicate that the vibratory loads for this study, especially the vertical loads, are likely to be more challenging to the SFP than those from the actual events.

#### Structural and Construction Details

The seismic design loads for the various reactors considered in this comparison differ, for the most part, from the design basis loads for the SFP considered in this study. A possible exception to this would be Unit 1 at Fukushima Daiichi, which initially considered comparable seismic design-basis loads. However, seismic design basis loads for Unit 1 were subsequently revised upwards (those are the design loads reported in this comparison).

The depth of the 20 SFPs affected by the recent earthquakes in Japan is similar to that for the SFP considered in the study. The horizontal dimensions for the SFPs in Fukushima Daiichi (EW and NS dimensions with reference to Figure 17) are also similar with the exception to the



SFP for Unit 1, which has a significantly smaller NS span that tends to make the SFP for Unit 1 less vulnerable to seismic loads. The thickness of the floor slabs for the SFPs at Fukushima Daiichi are likely similar to those for the SFP considered in the study. The SFP for which more structural details were known at the time of the writing of this report is the SFP for Unit 4 at Fukushima Daiichi (hereafter referred to as Unit 4). The following provides a comparison of structural details for Unit 4 with those of the SFP considered in this study.

- For Unit 4, the thickness of the SFP floor is about 1.5 m (about 5 ft) which is less than the thickness of the floor of the SFP considered in this study which is about 1.83 m (about 6 ft).
- Available information indicates that the reinforcement of the wall of the SFP in Unit 4 is not significantly different from the reinforcement in the wall of the SFP considered in this study.
- Although no reference is made to out-of-plane shear reinforcement for Unit 4 of Fukushima Daiichi, it is not known with certainty at the time of the writing of this report if out-of-plane shear reinforcement was provided at the edges of the floor slab of Unit 4 or at the intersection of this floor slab with the vertical walls.
- For the SFP of Unit 4 no reference is made to a grid of steel beams analogous to that embedded in the floor and bottom of the walls of the SFP considered in this study (used to support the weight of wet concrete during construction).
- Cross section drawings of the reactor building for Unit 4 indicate the possibility of a load bearing wall under the South wall (with reference to Figure 17) of the SFP of Unit 4, which does not exist for the SFP considered in this study. This difference, if confirmed, would result in a longer span for the entire structure of the SFP considered in this study.

Although there are differences between the structures of the Unit 4 SFP and the SFP considered in this study, these differences do not seem to be sufficiently significant to assert without further analysis that the Unit 4 SFP would be stronger for the same seismic demands than the SFP considered in this study. Differences in the vertical and horizontal response spectra at the foundation of Unit 4 and at the base of reactor building considered in this study (a fixed base structure) (see Figure 32 and Figure 31) indicate that the seismic forces for Unit 4 would have been significantly less than those considered in this study. The difference between these seismic demands would have been the main factor affecting the relative performance of the Unit 4 SFP (under the March 11, 2011 earthquake) and the performance of the SFP considered in this study under the hypothetical beyond design basis earthquake.

Major observations from these comparisons are:

- For the challenging events that affected 20 reactors and SFPs, leakage from the bottom of the SFPs of the 20 BWR reactors was not reported. This is consistent with the highest relative likelihood estimate for this study being that for the state with no leakage.
- Possible differences in the design and construction of the reactor buildings and SFPs, which considered higher design-basis seismic loads, and the SFP considered in this study, introduces uncertainties in these observations.
- The ground motion used in this study may be more challenging for the spent fuel pool structure than those experienced at the Fukushima Daiichi nuclear power plant from the earthquake that occurred on March 11, 2011, off the coast of Japan, which did not cause spent fuel pool leaks at the bottom of the walls.

## 5. SCENARIO DELINEATION AND PROBABILISTIC CONSIDERATIONS

### 5.1 Representative Operating Cycle Characterization

This section captures initial and boundary conditions related to the assumed operating cycle, as well as other related assumptions about the contents and layout of the SFP. Specifically, Table 15 captures these boundary and initial conditions for the high-density loading configuration and the alternate low-density loading configuration. Information about the operating cycle length and outage length are based on averages of this information for the last five operating cycles at the reference plant.

**Table 15 Remaining Boundary and Initial Conditions**

Item	High-Density Loading	Low-Density Loading (if different)
General: Operating cycle duration	23 months	—
Rack geometry: Support leg height Cell pitch Open vs. closed cell # of storage locations	18.41 cm (7.25 in.) <sup>1</sup> 15.95 cm (6.28 in.) Closed cell <sup>2</sup> 3,819	— — — —
Fuel loading Min. assem. during outage <sup>3</sup> Max assem. during outage # of assem. after outage Newer fuel (<5 years) Older fuel (>5 years) Pattern for “hot” fuel Coherent downcomer area <sup>7</sup>	3,819 – 764 – 284 = 2,771 3,819 – 764 = 3,055 <sup>4</sup> 3,819 – 764 = 3,055 GE14/GNF2 <sup>5</sup> Actual, based on 2003 info. prearranged in 1x4 <sup>6</sup> Yes	284 × 2 = 568 284 × 3 = 852 284 × 3 = 852 — N/A 1x4 “with empties” —
Outage specifications: Shuffling vs. full core offload Removal of weir gate Start of defueling Completion of defueling Start of refueling End of refueling Replacement of weir gate End of outage Cycle length	Shuffling (roughly 1/3 core) <sup>8</sup> 2 days (after subcriticality) 2 days 8 days 14 days 20 days 20 days (modeled as 25 days) 25 days 700 days (23 months) <sup>9</sup>	— — — — — — — — — —

<sup>1</sup> Later in the conduct of the study the authors became aware that the distance between the pool floor liner and the bottom of the rack baseplate is actually (on average) closer to 26 centimeters (cm) (10.25 in.), depending on adjustments made to the leveling pad during installation. For the cases studied in this report, in which the leakage location is at the junction of the floor and side wall, side calculations have shown that the results are insensitive to this difference (i.e., even at 18 cm sufficient cross-sectional flow area exists to accommodate natural circulation flow). Nonetheless, any future analyses for this site (particularly if they involve leak locations on the pool side wall), should consider correcting this error.

<sup>2</sup> This terminology refers to a rack design in which the sides of the rack cells have panels that inhibit or prevent cross-flow, while being relatively open at the top and bottom for axial flow.

<sup>3</sup> It is assumed that a full core offload capability (an industry commitment as opposed to a regulatory requirement) is maintained. Further, it is assumed that 284 assemblies are offloaded each outage (roughly

37 percent of the core) based primarily on the information in Exelon (2011), with a slight change from 270 to 284 assemblies for MELCOR modeling convenience.

Sixty of these rack locations may be reserved for storing guide tubes. The study does not address this situation, but it is expected to have a very minor effect on the results. By assumption, these 60 rack cells are filled with very low decay heat fuel, and represent less than 2 percent of the overall SFP inventory (and less than 2 percent of the radionuclide inventory available for release).

See Exelon (2011) for more information.

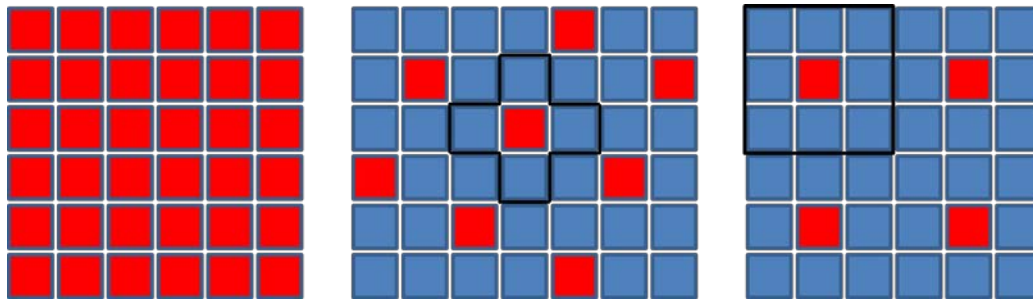
See Section 9.3 of this report for a discussion of how the use of contiguous (uniform) patterns would affect the results.

This term is used to describe whether an open area exists within the pool (such as an unracked region, a cask laydown area, or large gaps between the edge of the racks and the pool walls) that would facilitate downflow during conditions resulting in natural circulation air flow under the rack baseplate.

Note that the decay heat from the fuel left in the reactor is considered when the pool and reactor well are hydraulically connected.

After results were calculated based on a 700 day operating cycle, the authors realized that the correct operating cycle length should be 725 days (including the 25 day outage) rather than 700 days (which didn't include the outage). This error is expected to have a small impact on the overall results.

The above table depicts a 1x4 storage pattern for the recently discharged fuel, based on the approach PBAPS has taken to meet the requirements associated with license condition 2.C.(11) and 10 CFR 50.54(hh)(2). The plant studied actually currently utilizes a 1x8 pattern. Because this pattern is believed to be atypical (relative to the fleet), it is not modeled as the base case in this study. Section 9.2 of this report provides additional analysis that shows the benefit of the 1x8 pattern. Section 9.3 discusses of how the use of contiguous (uniform) patterns would affect the results. Figure 34 illustrates the different patterns.



**Figure 34 Illustration of SFP patterns**

From left to right: Uniform/contiguous; 1x4 (used as base case);  
1x8 (actually used by plant as of May 2012)

Red = a recently discharged assembly; Blue = an older, lower decay heat assembly, black outline shows repeating pattern

## 5.2 Operating Cycle Phase Specification

As described in Section 1.5, constant changes to the conditions in the SFP affect the consequences of a postulated accident (e.g., changes in the decay heat, changes in the inventory of fuel in the pool). Thus it is necessary to discretize this continuous behavior into a manageable set of discrete quasi-steady snapshots. Further, it must be recognized that the number of quasi-steady snapshots (or OCPs as they are termed throughout this report) has roughly a linear scaling effect on the number of MELCOR analyses that must be performed. As such, defining the OCPs becomes a minimization/optimization problem (i.e., the analysis needs to minimize the number of OCPs while optimizing the resulting OCPs' accuracy in representing the above pool-reactor configurations/spent fuel loading configurations/decay heat levels).

Based on these considerations, timing associated with the movement of fuel and key changes in plant configuration were combined with the peak assembly and whole pool decay heat curves to arrive at a set of five OCPs, as outlined in Table 16.

**Table 16 OCP Definition for the Modeled Operating Cycle**

OCP #	OCP Description	Time (d)	% of operating cycle	Pool-reactor configuration	Modeled spent fuel config. for high-density loading	Total decay power	Peak assembly power
1	Defueling of the reactor (~ 1/3 core)	2–8	0.9	Refueling	1x4	Existing <sup>1</sup> + (27% of offloaded assemblies) @ 4 days <sup>2</sup>	Highest powered offloaded assembly @ 4 days <sup>2</sup>
2	Reactor T&M / inspection and refueling	8–25	2.4	Refueling	1x4	Existing <sup>1</sup> + (offloaded assemblies) @ 13 days <sup>2</sup>	Highest powered offloaded assembly @ 13 days <sup>2</sup>
3	Highest decay power portion of nonoutage period	25–60	5	Unconnected	1x4	Existing <sup>1</sup> + (offloaded assemblies) @ 37 days <sup>2</sup>	Highest powered offloaded assembly @ 37 days <sup>2</sup>
4	Next highest decay power portion of nonoutage period	60–240	25.7	Unconnected	1x4	Existing <sup>1</sup> + (offloaded assemblies) @ 107 days <sup>2</sup>	Highest powered offloaded assembly @ 107 days <sup>2</sup>
5	Remainder of operating cycle	240–700; 0–2	66	Unconnected	1x4	Existing <sup>1</sup> + (offloaded assemblies) @ 383 days <sup>2</sup>	Highest powered offloaded assembly @ 383 days <sup>2</sup>

<sup>1</sup> The term “existing” refers to the fuel residing in the SFP at t = 0 (before offload).

<sup>2</sup> These times are based on mean decay heat load (as opposed to mean time) during the specified phase (see text for additional discussions); time zero is set to the time of reactor shutdown

The following key assumptions in the above OCP definition warrant highlighting:

- The study does not explicitly treat the offloading of older fuel into casks (as part of the normal fuel management practices as opposed to an expedited fuel movement program). Rather, a stylized assumption is made that the 284 assemblies that would be loaded into dry casks during the operating cycle are instantaneously removed from the pool just before the outage.
- The study does not treat new fuel. This fuel would be placed into the SFP just before the outage (the subject plant does not use a separate new fuel vault). Thus, the fuel would only be present for a very short portion of the operating cycle. During the time that the new fuel is in the SFP, it would affect the amount of zirconium available to

participate in a propagating zirconium fire, but would have a negligible effect on the source term.<sup>6</sup>

- The actual time at which the snapshots are evaluated is based on the mean decay heat during the OCP, as opposed to the mean time. Recall that the OCP snapshots are intended to represent a continuous function of possible consequences. While the likelihood of a seismic event occurring is constant in time within one of these OCPs, the consequences associated with the event are not. Furthermore, the exponential decay heat function better represents the change in the post-accident timeline within an OCP than does a linear function, and provides a better mean estimate of the OCP's expected consequences. Therefore, the exponential functional form is used to determine the time within the OCP that is used for the quasi-steady evaluation. In the case of OCP1, a minor adjustment is made from 4.4 to 3.9 days for modeling convenience (the model is nodalized such that having 88 recently discharged assemblies can be more readily represented, and 3.9 days is the point at which this many assemblies would have been offloaded given the outage assumptions previously discussed).

### **5.3 Treatment of Mitigation**

One of the objectives of this study is to provide insights into the effectiveness and benefits of mitigation measures currently employed at nuclear power plants. In addition to the redundant and diverse physical systems designed to prevent severe accidents, NRC requires plant owners to have preplanned emergency measures in the unlikely event an accident occurs. When they are successfully implemented, NRC expects these emergency measures will mitigate accident consequences by preventing, delaying, or reducing a potential release of radioactive material from the SFP. These measures include a site-specific emergency plan, emergency operating procedures, severe accident management guidelines, and 10 CFR 50.54(hh)(2) mitigation measures put in place to respond to the loss of large areas of the plant due to fires or explosions. NRC requires its licensees to train and practice emergency measures to ensure that they have proper equipment, procedures, and training. NRC inspectors periodically observe these activities to help ensure that NRC regulations are met at each plant. The study assumes that the licensee's emergency response organization would implement these measures in accordance with approved emergency plans, procedures, and guidelines.

Regarding onsite mitigative actions, the assumptions chosen by the project team to define the scenarios analyzed using MELCOR and MACCS2 are described here. Two cases are modeled for each scenario, a mitigated case and an unmitigated case. In the mitigated case, the model includes what would happen if the operators are fully successful in carrying out onsite mitigating actions. However, NRC analyzes extreme events to gain insights on the safety margin provided by NRC's regulatory framework. The uncertainties associated with the response to a beyond-design-basis seismic event, and the resultant effects on the SFP, make consideration of unmitigated scenarios prudent from an informed decision-making standpoint. Thus, each scenario is also analyzed assuming that the operators are not successful in implementing onsite mitigating actions.

---

<sup>6</sup> The radioactive material that is of concern during an accident is the fission products generated while the fuel is in the reactor. The uranium dioxide (UO<sub>2</sub>) present in fresh fuel would not contribute noticeably to the source term, and in particular, not in a SFP accident in which the temperatures during a postulated accident are lower than those during a reactor accident.

In the unmitigated case, all onsite mitigative actions are unsuccessful for an extended period of time, meaning that there is no credit for repair or recovery of damaged systems (e.g., offsite power) and no credit for successful deployment of 10 CFR 50.54(hh)(2)<sup>7</sup> equipment. The cases which assume lack of successful mitigation are presented to (1) acknowledge uncertainties in the effectiveness of these efforts during a beyond-design basis event and (2) demonstrate the effectiveness of successful mitigation. Section 5.3.2 of this report discusses further the rationale for developing results for this situation.

In the mitigated case, (1) mitigative actions associated with the regulatory requirements of 10 CFR 50.54(hh)(2) are successfully deployed, (2) additional onsite capabilities are used to extend the use of this equipment, and (3) arrival of offsite resources allows this equipment to be utilized for an extended period of time (e.g., days) until onsite capabilities can be recovered.

This study's original scope did not include an attempt to quantify the likelihood of successful execution of different mitigative actions that might take place (e.g., makeup using a portable pump, recovery of ac power). Subsequent to completion of the MELCOR (Chapter 6) and MACCS2 (Chapter 7) analyses described in the following chapters, the project staff performed a human reliability analysis for the purpose of providing context regarding human response. The HRA results provide informative data to gain insights on the likelihood of mitigation being successfully implemented as well as possible regulatory enhancements for consideration. Chapter 8 describes the HRA. Since the HRA was performed after the bulk of the analysis was completed, some of the assumptions differ from those described in this Section.

In addition to onsite mitigation, offsite support is considered in the paragraphs below.

The reference plant is supported by an offsite emergency operating facility (EOF). The emergency response organization at the EOF has access to fleetwide emergency response personnel and equipment, including the 10 CFR 50.54(hh)(2) mitigation measures and equipment from the sister plants. Every licensee participates in full onsite and offsite exercises every 2 years where response to severe accidents and coordination with offsite response organizations is demonstrated and inspected by the NRC and the Federal Emergency Management Agency. In addition, the Institute for Nuclear Power Operations and the Nuclear Energy Institute would activate their emergency response centers to assist the site as needed.

Concurrent with the industry response, the U.S. National Response Framework (NRF) would establish a coordinated response of national assets. As described in the Nuclear/Radiological Incident Annex to the NRF, the NRC is typically the Coordinating Agency for incidents occurring at NRC-licensed facilities. As Coordinating Agency, the NRC has technical leadership for the Federal Government's response to the incident. The NRF conducts periodic exercises and provides access to the full resources of the Federal Government. The NRC has an extensive, well-trained and exercised, emergency response capability and has onsite resident inspectors. The NRC would activate the incident response team at the NRC regional office and Headquarters. The focus of the NRC response is to ensure that public health and safety are protected and to assist the licensee with the response.

---

<sup>7</sup>

This section of the regulations deals with the development and implementation of guidance and strategies intended to maintain or restore core cooling, containment, and SFP cooling capabilities under the circumstances associated with loss of large areas of the plant resulting from explosions or fire.

However, for the large beyond-design-basis seismic event under consideration in this study, it is possible that significant damage to local infrastructure could occur, requiring emergency resources to also be needed in other areas. Additionally, radiation and other hazards (discussed in Section 5.3.2 of this report) could hinder access to the SFP and key equipment, making prevention or truncation of an ongoing SFP release challenging.

Considering the uncertainties associated with this event as described above, project staff chose a 72-hour time truncation (assumed that the event would be terminated by some means by 72 hours after initiation). The use of a time truncation is a point of uncertainty that can significantly affect the results and is further analyzed in Section 9.8 of this report. Note that like other aspects of this study, the incorporation of ongoing changes in regulatory commitments related to offsite response emanating from the Japan Lessons Learned initiatives is beyond this study's scope.

Regarding offsite support for these situations, the accident progression analysis assumes the following for the purposes of this study:

- Within 24 hours, offsite support arrives.
- Within 48 hours, actions are planned and equipment is staged.
- At 48 hours, if the fuel is not uncovered and the pool can be refilled with an injection rate of 500 gpm (which is true for the cases with no leak or a small leak), the sequence is truncated.
- Otherwise, the sequence is run to 72 hours because of the additional complexities of (1) accessing the area of the pool when the fuel is uncovered and stopping an ex-containment release in progress and (2) performing a large leak repair.

These assumptions are similar to the assumptions used in NUREG-1935, "State-of-the-Art Reactor Consequence Analyses Project" (NRC, 2012i).

Table 17 summarizes each situation.

**Table 17 Summary of Mitigation Assumptions**

<b>Item</b>	<b>Situations with successful deployment of onsite mitigation</b>	<b>Situations without successful deployment of onsite mitigation</b>
Installed accident mitigation equipment	Damaged by the event; recovery/repair not credited	
10 CFR 50.54(hh)(2) equipment	Successfully deployed 2 hours after diagnosis	Not credited
Other onsite resources	Successfully deployed to extend operation of 10 CFR 50.54(hh)(2) equipment	Not credited
Offsite resources	Successfully deployed for terminating the accident at 48 or 72 hours (see Section 9.8)	
Emergency preparedness	Effective (see APPENDIX A: of this report for more details)	
Mitigation equipment being considered under NRC Order EA-12-049, dated March 12, 2012	Not considered; may be substantively similar to 10 CFR 50.54(hh)(2) capabilities within the context of this study	

### 5.3.1 Approach Details and Assumptions

Scenarios that credit successful deployment of the 10 CFR 50.54(hh)(2) measures must include assumptions about how that deployment is executed. In general, this study utilizes some of the limits associated with these capabilities that are contained in Nuclear Energy Institute (NEI) 06-12, Revision 2, “B.5.b Phase 2 & 3 Submittal Guidance,” issued December 2006 (which the NRC has endorsed<sup>8</sup>). For instance, the time at which the mitigative capability is assumed to commence (meaning that it has been deployed and is starting to operate) is 2 hours after diagnosis. The guidance in NEI 06-12, Revision 2, does include a provision that allows for a deployment time of 5 hours after diagnosis for spray, if the fuel has been favorably configured. This study does not invoke that provision because the site in question strives to deploy the equipment within 2 hours regardless of the fuel pattern and the existence of cases without successful deployment of mitigation envelopes this effect.

The flow rates associated with the two modes of delivery considered (spray and makeup) are assumed to be the minimum amounts required (200 gallons delivered per minute for spray and 500 gallons delivered per minute for makeup). For PBAPS, the capacities of the available equipment are somewhat higher. The use of the 500 and 200 gpm values in this study attempts to account for uncertainties in the speed at which the pumps would actually be run, as well as spray that goes outside the boundary of the pool.<sup>9</sup> As a result, no additional “penalty” is given

<sup>8</sup> The NRC originally endorsed this document for operating reactors by letter dated December 22, 2006 and this endorsement was carried forward in the Statement of Considerations for the associated rulemaking (see “Power Reactor Security Requirements, Final Rule,” published in the *Federal Register* on March 27, 2009). B.5.b refers to Section B.5.b of Order EA-02-026, dated February 25, 2002, and later made generically applicable in 10 CFR 50.54(hh)(2).

<sup>9</sup> MELCOR does not model the details of the spray delivery from the nozzle(s) to the SFP. Rather, it assumes a uniform flux of water at the top of the SFP. A system flow rate of greater than 200 gpm is necessary to achieve this uniform 200 gpm-equivalent spray flux, to allow for water striking the pool deck or walls and not



for inefficiencies associated with spray coverage (i.e., the spray flow rate is applied uniformly across the pool cross-sectional area without further reduction). In either spray or makeup mode, the licensee would utilize a portable diesel-driven pump to pump water from either the fire ring header, the intake canal, or the emergency cooling tower basin to the refueling floor via hoses that would be run up a reactor building stairwell.

The following set of criteria was established to model the time to diagnosis of the need to deploy 10 CFR 50.54(hh)(2) mitigative strategies:

- no ac power
- SFP level decrease by 1.5 m (5 ft), keeping in mind that 0.5 m (1.5 ft) is lost because of sloshing
- 30-minute delay associated with manual observation/decision-making

These criteria were developed with consideration of the plant-specific procedures for problems associated with the SFP, though these specific criteria do not exist in those procedures and they are not intended to represent a specific procedural pathway. It is also important to note that, for the plant studied, the various procedures related to loss of SFP cooling or loss of SFP inventory do refer plant personnel to the guidelines for use of the 10 CFR 50.54(hh)(2) equipment, even if the cause of the event is not a loss of large area of the plant. More specifically, if control room alarms are available, the loss of inventory would cause an alarm that would direct the operators to a local panel on the refuel floor. The alarm procedure would also start a procedural pathway that would explicitly lead to consideration of the use of the 50.54(hh)(2) equipment. If control room alarms are not available, the special event procedure related to an earthquake directs the operators to inspect the status of the SFP and its cooling systems. The special event procedure also triggers a procedural pathway that would explicitly lead to consideration of the use of the 50.54(hh)(2) equipment. Note that the details of onsite response are covered more thoroughly in Chapter 8.

The above criteria could be conservative or nonconservative depending on the priorities of operators, and different criteria would clearly be more applicable to other scenarios, particularly those that did not include loss of offsite and onsite power at time zero. The assumption that pool elevation must drop 5 ft can lead to long diagnosis time periods for slowly progressing events, thus leading to a potentially conservative timeline for mitigative action. However, these same slowly developing scenarios are the ones that are least important for offsite consequences (i.e., are less severe and less likely to lead to a release). The use of a 2-hour deployment time, as opposed to a 5-hour deployment time allowed in some situations, has a compensating effect for some scenarios. Chapter 8 discusses the issue of diagnosis in greater detail.

Regarding the implementation mode, for cases in which the water level in the pool is greater than 0.9 m (3 ft) above the top of the racks (a surrogate for high radiation levels on the refueling floor near the edge of the SFP (see Section 5.4 of this report)) at the earliest time the sprays/makeup are ready for initiation (i.e., 2 hours after diagnosis), makeup will be utilized. Otherwise, sprays will be utilized. This represents one possible approach to the decision point

---

entering the pool. The regulatory implementation of 10 CFR 50.54(hh)(2) accounts for this inefficiency effect.

in Figure 2-1 of NEI 06-12, Revision 2 (NEI, 2006), regarding whether SFP leakage is excessive. In some respects it is a more complicated approach than might be used, but is arguably a more straightforward approach to enact in the absence of instrumentation. In practice, both approaches end up prompting the same implementation mode for most scenarios studied in this report. The exception is for the “moderate” hole for OCP1/2, in which, because of the larger volume of water since the SFP is connected to the reactor well and separator/dryer pool, the water level has not reached the 3 ft mark (above the top of the racks) by the time mitigation is deployed. In these cases, makeup is deployed even though the leakage rate actually exceeds 500 gpm. Section 9.3 of this report investigates the effect of this assumption for a uniform pattern.

Whichever mode is initiated (spray versus makeup), it is assumed to be used for the duration of the event (i.e., no later switching to a different mode). For OCP 1/2 with the “moderate” leakage condition, makeup is deployed. Other, equally reasonable assumptions about mitigation deployment could result in the deployment of sprays instead (which have a potential advantage in terms of mitigation for these conditions). Section 9.3 presents a sensitivity study related to this assumption, for a uniform pattern.

Practically speaking, the above set of assumptions leads to the following process when establishing mitigation timeline boundary conditions in the MELCOR analyses (recall that this only applies for half of the studied sequences since each scenario has a calculation without successful deployment of mitigation):

- Start of calculation/earthquake occurs.
- When SFP level has decreased by 1.5 m (5 ft), and 30 (diagnosis delay) plus 120 (initial deployment delay) additional minutes have transpired, then the following applies:
  - If the water level is greater than 0.9 m (3 ft) above the top of the fuel, then 500 gpm of makeup into the top of the pool commences.
  - If the water level is less than 0.9 m (3 ft) above the top of the fuel (thus indicating excessive leakage) then 200 gpm of spray at the top of the pool commences.

The above assumptions are characterized as optimistic relative to the unmitigated (pessimistic) case. However, it is important to note that aspects of these assumptions assume failures where they may not occur. For instance, the above set of assumptions only credits a single successful spray/makeup strategy, whereas multiple strategies may be deployed. Along these lines, there are several other ways to recover makeup to the SFP, several of which have much higher capacities than the mode selected. Table 10.3.1 of the FSAR captures these alternatives, which range from capacities of 25 gpm to 18,000 gpm. For each of the modes capable of delivering more than 200-500 gpm (the mode selected in this study), these modes require either multiple manual alignments in the vicinity of the SFP and reactor, the availability of ac power for valve manipulations, or the use of equipment that might be involved in reactor recovery (most notably a residual heat removal pump), as well as ac power for pump operation. Finally, as mentioned previously, the selected set of assumptions does not allow for switching from one mode of makeup/spray to the other.

### 5.3.2 Rationale for Producing Unmitigated Results

NRC licensees that operate nuclear power plants are required to maintain the facility in a manner that makes the occurrence of a severe accident unlikely. This is achieved through a number of mechanisms involving facility design and operator training, and by applying the concept of defense-in-depth. Even so, uncertainties associated with the response to a beyond-design-basis seismic event, and the resultant effects on the SFP, make consideration of unmitigated scenarios prudent from an informed decision-making standpoint. Some specific issues relevant to the situation considered in this report include the following:

- The regulatory requirements for 10 CFR 50.54(hh)(2) equipment currently focus on the use of this equipment for responding to a loss of a large area of the plant from explosion or fire. Ongoing regulatory activities related to the NRC's response to the March 2011 accident at the Japanese Fukushima-Daiichi site will alter this situation (e.g., see NRC Order EA-12-049, dated March 12, 2012). Note that some plants (including the reference plant) have already acquired some additional equipment in anticipation of this requirement, with full compliance scheduled for 2016.
- The large seismic event could damage onsite (and offsite) infrastructure designed to facilitate accident response, as well as cause general disruption at the site.
- If circumstances led to the uncovering of fuel in the SFP, radiation fields on the refueling floor might hamper mitigative actions. Section 5.4 of this report describes the shielding analyses that inform this aspect of the accident analysis. Chapter 8 further discusses accessibility issues in the context of human response. Note that, as part of the implementation of 10 CFR 50.54(hh)(2), the licensee has committed to an ability to carry out the required mitigative actions even in such situations (e.g., using portable shielding or implementing from a location other than the refueling floor itself).<sup>10</sup>
- A concurrent reactor event (resulting from the loss of ac power or other damage), or an ongoing accident at the other unit's SFP, could hamper mitigative actions by reducing accessibility because of radiation fields, impeding accessibility because of other hazards such as hydrogen accumulation, or diverting resources (both personnel and equipment). Chapter 8 discusses this issue further.
- An assembly being moved within the SFP (or from the reactor to the SFP or vice versa) at the time of the event, could lead to an earlier radiological hazard for responders, if this assembly were to become uncovered earlier in the event progression, because of its higher position in the SFP. Section 5.4 of this report provides refuel floor dose rate estimates for this situation.
- Accessibility could be reduced if an inadvertent criticality event in the SFP were to occur. See Section 2.3 of this report for more information about inadvertent criticality events.

---

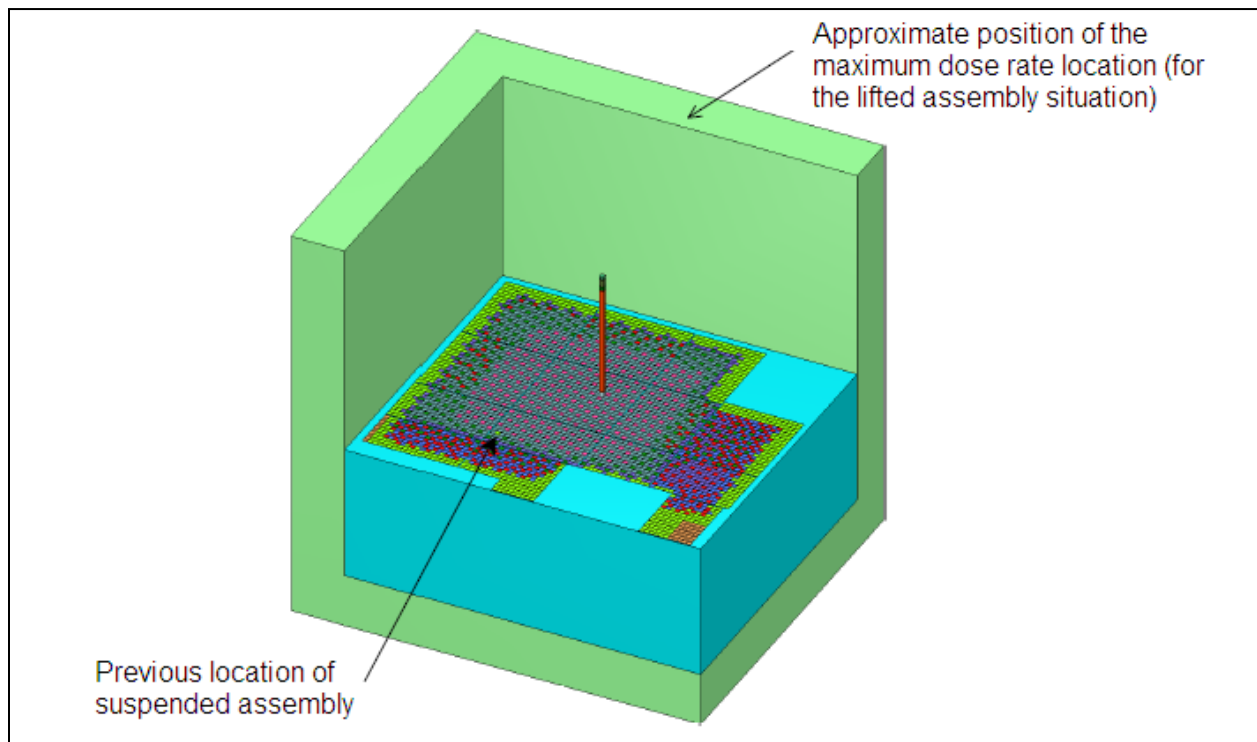
<sup>10</sup> The industry's FLEX proposal, developed in response to NRC Order EA-12-049, includes a specification for a means to connect makeup to the installed SFP cooling system to overcome the potential for lack of access to the SFP deck area. This is primarily to address the potential needs for makeup in a saturated condition caused by boil off for an uncooled pool.

For these reasons, this study presents results for cases in which accident mitigation efforts are unsuccessful for some period of time.

#### 5.4 Refueling Floor Dose Rate Analysis Using SCALE

This study included analyses to predict the radiological conditions on the refuel floor for a range of conditions associated with loss of water in the SFP. Note that the analyses described in this section only account for the radiological conditions stemming from neutron and gamma “shine” from exposed radioactive material and do not account for the concern of radiological conditions associated with the release of that material following fuel heatup. It is expected that, if a radiological release of fission products from the SFP were to commence, radiation fields in the vicinity of the pool would be extremely high.

The analyses described, which Oak Ridge National Laboratory (ORNL) performed, looked at a range of conditions. This range included both the high-density and low-density loading conditions studied in this report, as well as the situation in which a single assembly is in the lifted position at the time of the event. The times following discharge that were considered are the same as those associated with the different OCPs. This portion of the analyses is plant specific for the reference plant, and utilized 2011 vintage information for representing the fuel design and characteristics in the SFP. Calculations were performed using the ORIGEN and MAVRIC modules of the SCALE code suite. MAVRIC in turn used BONAMI, CENTRM, DENOVO, and Monaco routines, along with the FW-CADIS methodology. The analysis used the flux-to-dose conversion factors in American National Standards Institute/American Nuclear Society (ANSI/ANS) 6.1.1-1977. The 200 neutron group and 47 gamma group cross sections based on the ENDF/B-VII.0 cross-section library distributed with SCALE 6.1 were used.



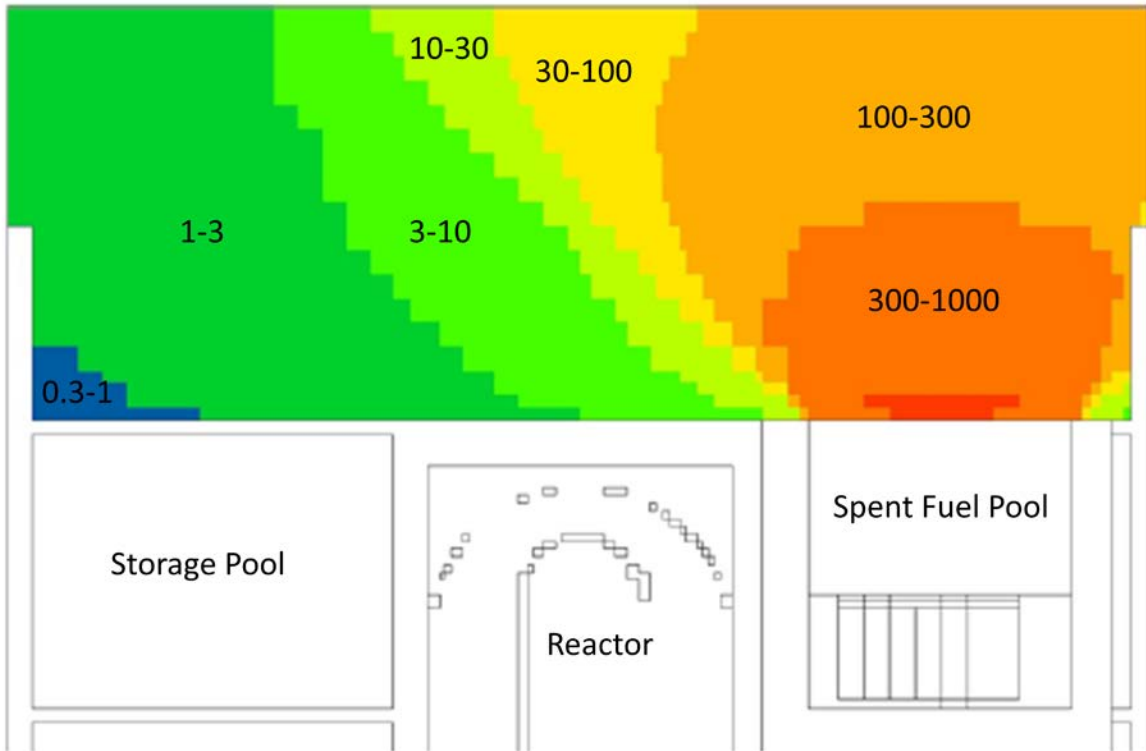
**Figure 35** Cutaway depiction of a lifted assembly with water level at the top of the racks

Results of the analyses for the high-density loading situation can be summarized as follows:

- For water depths of 3 m (10 ft) above the top of the racks, projected dose rates are very, very low (less than 0.1 millirem (mrem) per hour). This is consistent with Regulatory Guide 1.13, "Spent Fuel Storage Facility Design Basis," which uses this water depth as a conservative measure of adequate shielding.
- Dose rates for the maximally exposed location on the refueling floor once the water level drops to the top of fuel hardware are very high (on the order of 450 to 600 rem per hour, depending on the OCP).<sup>11</sup>
- At a water depth of 0.6 m (2ft) above the top of the fuel, the projected dose at the maximally exposed location on the refueling floor surpasses 25 rem in one hour. 25 rem is the value above which actions can be taken to save lives or protect large populations, on a voluntary basis, as defined in Table 2-2 of U.S. Environmental Protection Agency (EPA) 400-R-92-001, "Manual of Protective Action Guides and Protective Actions for Nuclear Incidents," issued May 1992)
- Dose rates elsewhere on the refueling floor are significantly lower than those at the maximally exposed location (e.g., see Figure 36).

---

<sup>11</sup> This range shows that, for situations in which the water level is at the top of the fuel hardware, the dose rates are somewhat sensitive to the time during the operating cycle (a 33-percent decrease in this case). For instances in which water is covering the fuel hardware, this sensitivity decreases. For example, the analogous range of values for a water level 100 cm (3.3 ft) above the fuel hardware is 1.6 to 1.7 rem per hour.



**Figure 36 Approximate dose rate of elevation contours, water at top of fuel hardware, around the time of defueling (rem per hour).**

Relative to the high-density loading situation, the other situations can be compared as follows:

- For low-density loading situations, dose rates for the maximally exposed location on the refueling floor once the water level drops to the top of fuel hardware are lower than the high-density loading case, but still very high (on the order of 300 to 470 rem per hour, depending on the OCP).
- For a recently discharged assembly in the lifted position, dose rates for the maximally-exposed location are on the order of 3 rem per hour when the water level is at the top of the lifted assembly and over 1,000 rem per hour when the water level is at the top of the racks (i.e., when the lifted assembly is completely exposed). These are dose rate contributions solely from the lifted assembly (i.e., they are in addition to the dose rate contributions from the assemblies in the racks).
- For an older assembly (discharged more than a decade previously) in the lifted position, dose rates for the maximally exposed location are on the order of 0.2 rem per hour when the water level is at the top of the lifted assembly and 7 rem per hour when the water level is at the top of the racks. Again, these are dose rate contributions solely from the lifted assembly.

The high dose rates associated with the single lifted assembly (particularly those for the recently discharged assembly) are sensitive to the assumed position of that assembly. This case assumes that the assembly is located somewhere near the middle of the pool (see

Figure 35), which results in direct line-of-sight from the edge of the SFP. Placement near a wall would reduce the dose rate for locations near the edge of the pool that do not have a direct line of sight to the assembly.

## **5.5 Discussion of Repair and Recovery**

This study makes no attempt to account for repair or recovery of onsite equipment or offsite power. This is a simplifying assumption, and is motivated in part by the lack of quantitative information available to support such a determination for the large seismic event being considered. Procedures would direct the operators to attempt to recover failed equipment and pursue alternate means of establishing ac power, such as the ability to obtain ac power from an SBO cross-tie line to the Conowingo Dam. The study assumes that the damage sustained by the onsite and offsite electrical distribution systems from the earthquake is enough to significantly delay these recoveries until after the 48- or 72-hour truncation times.

That being said, and as covered previously in this section, the scenarios with successful deployment of mitigation do assume that onsite and offsite resources are able to extend operation of the 10 CFR 50.54(hh)(2) equipment indefinitely, which could represent a situation in which ac power is recovered at an intermediate point and ac-dependent means of SFP makeup are brought back online.

## **5.6 Scenario Development**

### **5.6.1 Identification of Key Events**

The scenario development included the following major assumptions based on the structural analysis documented in Section 4 of this report or other considerations:

- All offsite and onsite ac power is lost as a direct result of the seismic event (see Section 4.2 of this report).
- Direct current power may be lost. Because of the difference from the reactor situation (in which dc power to control turbine-driven systems is important in an SBO), the availability or unavailability of dc power has a much narrower effect. For the specific set of assumptions used in the MELCOR and MACCS2 analyses, there is no effect as analyzed. Chapter 8 further discusses this issue with respect to the HRA.
- The 10 CFR 50.54(hh)(2) equipment (when credited) is available for the duration of the event, following delays associated with diagnosis and deployment (see Section 5.3.1 of this report).
- Initial water loss from “sloshing” will be 0.5 m (1.5 ft) (see Section 4.2 of this report).
- Tearing of the SFP liner is not the most probable outcome, but is possible (see Section 4.1 of this report).
- There is no failure of penetrations, including the refueling transfer canal gate (see Section 4.2 of this report).

- The overhead structures (building debris, crane) do not pose a threat to the SFP in terms of failure resulting from the initiating event (see Section 4.2 of this report).
- Inadvertent criticality, including seismic effects on the integrated poison rack material, is not treated (see Section 2.3 of this report).

### 5.6.2 Scenario Calculation Matrices

The following table shows how the combinations described thus far translate to the scenarios considered for each OCP.

**Table 18 Scenario Breakdown per OCP**

Case #	Scenario Characteristics		Radioactive Release Commences before 72 Hours?	
	SFP Leakage Rate?	Mitigation?	High-Density Loading—1x4	Low-Density Loading
1	None	Yes	See later sections of the report for results	
2		No		
3	Small	Yes		
4		No		
5	Moderate	Yes		
6		No		

### 5.6.3 Summary of Event Split Fractions

As described previously, the analysis considered the available seismic hazard information to obtain an initiating event frequency of approximately one event in 60,000 years for the reference plant.

**Table 19 Refresher on the Seismic Hazard Estimates**

Seismic Bin #	PGA Range (g)	Geometric Mean Accel. (g)	Likelihood based on PGA (yr)	Likelihood based on PGA (/yr)	Potential for damage to SFP liner?
1	0.1 to 0.3	0.2	1 in 2,000	$5.2 \times 10^{-4}$	Damage not expected
2	0.3 to 0.5	0.4	1 in 40,000	$2.7 \times 10^{-5}$	Damage not expected
3	0.5 to 1.0	0.7	1 in 60,000	$1.7 \times 10^{-5}$	Damage possible
4	> 1.0	> 1.0	1 in 200,000	$4.9 \times 10^{-6}$	Damage possible

Regarding the probability of losing ac power from this particular seismic event, the results described earlier in this report are summarized below.



**Table 20 Refresher on ac Fragility**

Item	Relative Likelihood	Comments
Loss of normal SFP cooling	0.84	This study used the ac power fragility from NUREG-1150 of 0.84 as a surrogate for the conditional probability of normal SFP cooling and makeup not being available. This simplifying assumption was made in light of the fact that the study is not a PRA (but rather a consequence analysis with probabilistic considerations) and that this value already approximates the upper bound of 1. In reality, the availability of normal SFP cooling and makeup would be a combination of the AC fragility, the fragility of the actual equipment and its support equipment, and operator actions to recover the equipment, which could result in a conditional probability higher than the value used here.

As described previously, the structural assessment led to the SFP leakage estimates stated below.

**Table 21 Refresher on SFP Leakage Conditional Probabilities**

Damage State	Relative Likelihood	Comments
No leakage	0.9	Significant damage to concrete; no rupture of SFP liner
“Small” leakage	0.05	Small rupture of SFP liner; drains pool in tens of hours
“Moderate” leakage	0.05	Tearing of SFP liner; damaged concrete limits outflow; drains pool within ones of hours

Finally, since a seismic event is equally likely to happen throughout the operating cycle, the conditional probability for its occurrence during a specific OCP is simply the duration of that OCP divided by the duration of the operating cycle. These weights range from 1 percent for OCP1 to 66 percent for OCP5 (recall that the OCPs were intentionally “front loaded” because the most change in SFP conditions occurs during the outage).

**Table 22 Refresher on the OCP Fractional Contributions**

OCP #	Time window (Time of evaluation) (in days)	Fraction of operating cycle	Pool-reactor configuration	Spent fuel configuration for high-density loading
1	2–8 (5)	0.01	Refueling	Dispersed (except for Section 9.3)
2	8–25 (13)	0.02		
3	25–60 (37)	0.05	Unconnected	Dispersed
4	60–240 (107)	0.26		
5	240–700 and 0–2 (383)	0.66		

The above conditional probabilities are combined, algebraically, to provide likelihoods associated with each of the different sequences treated. At times, sequences are grouped (e.g., those that lead to a release versus those that do not), so as to assign scenario-specific release frequencies, scenario-specific individual risk of an LCF, or the like. It is important to keep in mind that all such frequencies only consider the particular large seismic event studied in this report.

## 6. ACCIDENT PROGRESSION ANALYSIS

### 6.1 Modeling Spent Fuel Pools with MELCOR

#### 6.1.1 Overview and Experimental/Analytical Basis

The MELCOR computer code (Gauntt, 2005) represents the current state of the art in severe accident analysis. MELCOR has been developed through the NRC and international research performed since the accident at Three Mile Island in 1979. MELCOR is a fully integrated, engineering-level computer code and includes a broad spectrum of severe accident phenomena with capabilities to model core heatup and degradation, fission product release and transport within the primary system and containment, core relocation to the vessel lower head, and ex-vessel core concrete interaction.

The MELCOR code comprises an executive driver and a number of major modules, or packages, that together model the major systems of a reactor plant and their generally coupled interactions. The various code packages have been written using a carefully designed modular structure with well-defined interfaces between them. This allows the exchange of complete and consistent information among them so that all phenomena are explicitly coupled at every step. The structure also facilitates maintenance and upgrading of the code. Plant systems and their response to off-normal or accident conditions include the following:

- thermal-hydraulic response of the primary reactor coolant system, the reactor cavity, the containment, and the confinement buildings
- core uncovering (loss of coolant), fuel heatup, cladding oxidation, fuel degradation (loss of rod geometry), and core material melting and relocation
- heatup of reactor vessel lower head from relocated fuel materials and the thermal and mechanical loading and failure of the vessel lower head, as well as transfer of core materials to the reactor vessel cavity
- core-concrete attack and ensuing aerosol generation
- in-vessel and ex-vessel hydrogen production, transport, and combustion
- fission product release (aerosol and vapor), transport, and deposition
- behavior of radioactive aerosols in the reactor containment building, including scrubbing in water pools, and aerosol mechanics in the containment atmosphere such as particle agglomeration and gravitational settling
- impact of engineered safety features on thermal-hydraulic and radionuclide behavior

MELCOR modeling is general and flexible, making use of a “control volume” approach in describing the thermal-hydraulic response of the plant. No specific nodalization is provided, which allows a choice of the degree of detail appropriate to the task at hand. Reactor-specific geometry is imposed only in modeling the reactor core. The MELCOR code has been modernized (source code upgrade to Fortran95) to provide an efficient code structure for ease of maintenance, resulting in the release of MELCOR version 2.1. The new upgraded version of the code architecture supports advancements in computer hardware and software, and the code numerics improvements are underway to carry out more reasonable execution times. The input structure for MELCOR 2.1 differs completely from that of MELCOR 1.8.6. MELCOR is an ideal tool for this type of application because (1) its capabilities have been recently developed and validated for treating SFP accidents and (2) it is able to model the accident progression, radionuclide release, and in-building transport/retention. MELCOR 1.8.6 was used in the

present study, and the SFP models in both versions of the code (1.8.6 and 2.1) are functionally the same.

As part of NRC's post-9/11 security assessments, the agency developed and applied SFP modeling using detailed thermal-hydraulic and severe accident progression models integrated into the MELCOR code to assess the realistic heatup of spent fuel under various pool draining conditions. SNL performed the analyses for a reference BWR, with additional supporting analyses for separate effects and fluid flow modeling using an earlier version of the code (MELCOR 1.8.5 Version RP) which is no longer maintained. Some of the modeling improvements in MELCOR 1.8.6 include revised modeling of the lower plenum to account for the curvature of the lower head (not relevant for an SFP) and formation and convection of stratified molten pools.

MELCOR 1.8.5 Version RP added two modeling enhancements applicable to BWR SFP modeling (also included in MELCOR 1.8.6 and 2.1): (1) a new rack component, which permits better modeling of an SFP rack and (2) a new oxidation kinetics model. The new BWR SFP rack component permits proper radiative modeling of the SFP rack between groups of different assemblies. The new oxidation kinetics model predicts the transition to breakaway oxidation in air environments on a node-by-node basis. These new SFP features can be used to perform two types of SFP calculations: (1) a partial loss-of-coolant inventory accident and (2) a complete loss-of-coolant inventory accident. A complete loss-of-coolant inventory accident is characterized by the draining of the water to uncover the bottom of the racks leading to air circulation patterns inside the pool and associated air oxidation of the cladding (pre- and post-breakaway) and enhanced ruthenium release. A partial loss-of-coolant inventory or boiloff accident could involve no or late uncover of the bottom of the racks. Boiloff of the coolant leads to steam generation and steam oxidation of the cladding and hydrogen generation that could lead to hydrogen combustion.

#### Breakaway Oxidation Model

Argonne National Laboratory (ANL) has performed oxidation kinetics testing on zirconium-based alloys, including Zircaloy-4 which is similar to the Zircaloy-2 alloy. The testing showed that air oxidation can be observed at temperatures as low as 600 K. In the tests, a specimen was held at constant temperature and the weight gain associated with oxidation as a function of time was measured. The reaction rates for air oxidation are described by parabolic kinetics similar to the ones used to describe steam oxidation. The general form of the equation is as follows:

$$\frac{dw^2}{dt} = K(T) \quad (1)$$

where,  $w$  is the reacted metal mass per unit surface area. The rate of oxidation was initially steady versus the square root of time at a particular temperature. However, the rate of oxidation increased after some time and persisted for the remainder of the test. The ANL pre- and post-breakaway Zircaloy-4 oxidation correlations are provided below.

The steam preoxidized, wide-temperature, prebreakaway Zircaloy-4 oxidation correlation (Natesan and Soppet, 2004) is as follows:

$$K(T) = 26.7 \exp(-17,490/T) \text{ [kg}^2/\text{m}^4 \cdot \text{s]} \quad (2)$$

The steam preoxidized, wide-temperature, postbreakaway Zircaloy-4 oxidation correlation (Natesan and Soppet, 2004) is as follows:

$$K(T) = 2.97E4 \exp(-19,680/T) \text{ [kg}^2\text{/m}^4\text{.s]} \quad (3)$$

The new oxidation model was implemented in MELCOR by adding a breakaway lifetime calculation. The model calculates an oxidation “lifetime” value for Zircaloy components in each cell using the local Zircaloy cladding temperature:

$$LF = \int_0^t dt' \frac{t'}{\tau(T)} \quad (4)$$

$$\tau(T) = 10^{P_{LOX}} \quad (5)$$

$$P_{LOX} = -12.528 \log_{10}T + 42.038 \quad (6)$$

where  $P_{LOX}$  is the MELCOR fit of the timing for the transition from prebreakaway to postbreakaway oxidation reaction kinetics for Zirlo and Zircaloy-4 in the ANL experiments.

The air oxidation model was benchmarked against experimental data from the SNL SFP facility as part of the security assessment work. The calculations with and without breakaway oxidation kinetics showed different heatup rates following breakaway. Both the data and the calculation with breakaway kinetics show a sharp increase in the heatup rate following breakaway. The new breakaway kinetics model provided a better prediction of the measured data, including a transition to accelerated postbreakaway oxidation kinetics.

#### Hydraulic Resistance Model

The MELCOR modeling approach for flowpaths connecting control volumes includes constitutive relationships to specify form losses (i.e., minor losses) and wall friction losses (i.e., major or viscous) along a flowpath as a hydraulic flow loss term to the momentum equation. The format of the user-specified input for MELCOR is defined from the sum of the local viscous and major pressure drops:

$$\Delta P = \frac{1}{2} \rho v^2 \left( f \frac{L}{D} + K \right) \quad (7)$$

where  $\rho$  is the fluid density,  $v$  is the fluid phase velocity,  $L$  is the inertial flow path length,  $D$  is a representative hydraulic diameter, and  $K$  is the form loss coefficient. The laminar friction factor ( $f$ ) is given as:

$$f = S_{LAM}/Re \quad (8)$$

where  $S_{LAM}$  is a user-specified MELCOR input parameter,  $Re$  is the Reynolds number ( $\rho v D / \mu$ ), and  $\mu$  is the fluid dynamic viscosity.

Hydraulic resistance measurements were performed on a Global Nuclear Fuel 9x9 BWR assembly at SNL (Durbin, 2005) to obtain the required frictional and form loss coefficients,

including the effects of grid spacer and partial rods. The present study used these measurements given a lack of data for a 10x10 BWR assembly.

### **6.1.2 Heat Transfer Modeling within Spent Fuel Pool and to Surrounding Walls**

The MELCOR core models calculate the thermal response of the core.<sup>12</sup> The core is nodalized into a number of axial levels and radial rings (each ring represents a collection of assemblies). All important heat transfer processes are modeled in each core cell, including thermal radiation within a cell and between cells in both the axial and radial directions, as well as radiation to boundary heat structures. Each core cell is hydraulically interfaced to a control volume to obtain the necessary boundary conditions (e.g., water level, flow velocity) and in turn supplies the calculated heat and mass transfer to the control volume. Each core cell may contain a number of components, including fuel, cladding, canister (BWRs), and other structures (e.g., control rods).

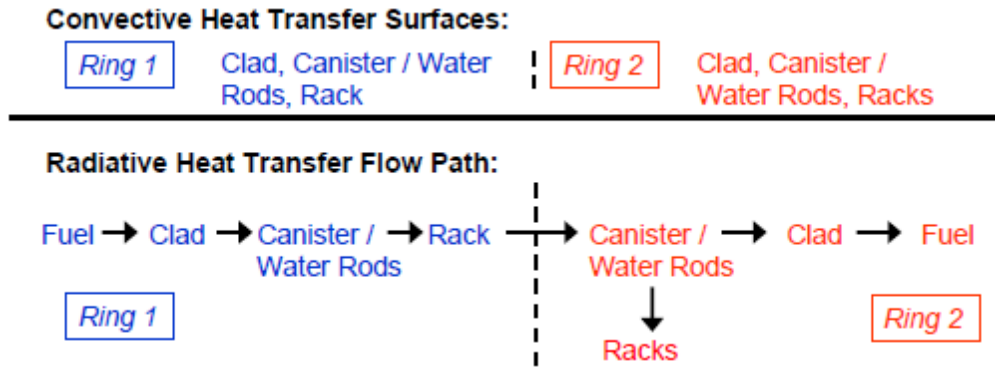
The new SFP rack component permits separate modeling of the SFP rack and radiative heat transfer between the rack and existing components in the core. The new air oxidation kinetics model predicts the transition to breakaway oxidation kinetics in air environments on a node-by-node basis. The SFP racks and the lower gap region below the SFP racks can be modeled using the existing core and lower plenum components. The MELCOR core model is designed in two-dimensional cylindrical geometry, and nodalization of the SFP must fit within this framework. Implicit in this framework is the assumed direction of heat and mass transfer between adjacent rings and adjacent elevations. For SFP models, the user can take advantage of this preexisting framework and arrange the fuel rack cells in a similar ring pattern.

The heat transfer paths modeled within the core are appropriate for conventional commercial light-water reactors. The capability has been added to define arbitrary (“generalized”) additional heat transfer paths between core components to allow for more flexible intracell radiation or conduction, but the user is responsible for defining a single input parameter that captures the geometry of the heat transfer path. Figure 37 depicts the heat transfer paths within a ring and across a ring boundary. For radiation between different core rings, the user adjusts the view factors and the surface areas.

The core models radiative heat transfer from the outermost ring components (if present) to the core boundary specified as a heat structure. The SFP wall is modeled as a heat structure composed of a steel liner and concrete which can receive radiative energy from the core as well as convective heat transfer from the adjacent control volume.

---

<sup>12</sup> MELCOR core models were originally designed for the reactor core. Because of the code flexibility, the same modeling approach can be used for the spent fuel pool (with the addition of the rack as a separate component). Therefore, as far as code models are concerned (e.g., heat transfer between groups of assemblies and with the fluid, and radionuclide release, transport and deposition), there is no difference between reactor assemblies and spent fuel assemblies. It is up to the user to define the proper information in the input deck.



**Figure 37 MELCOR modeling of heat transfer paths**

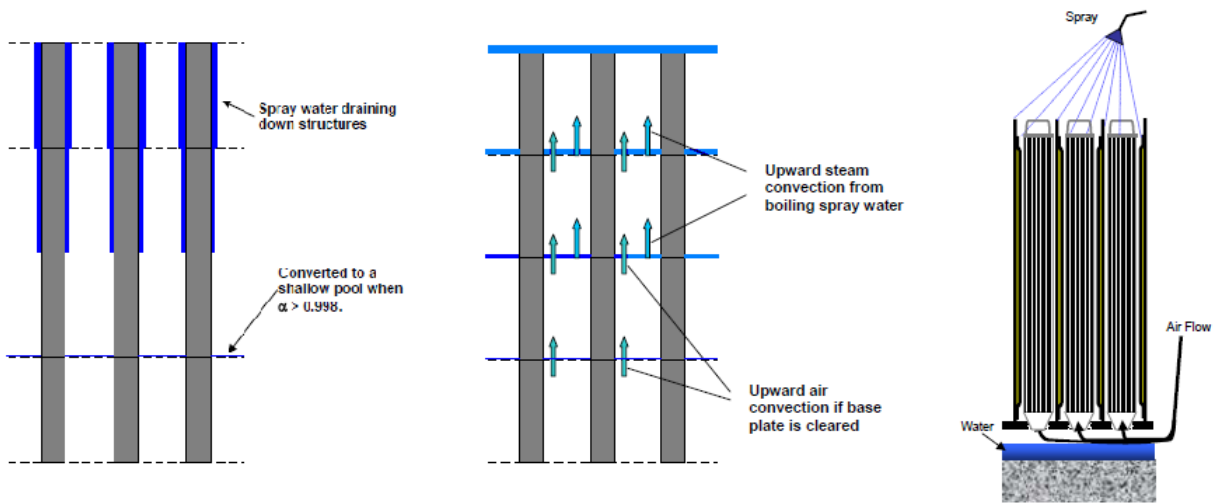
### 6.1.3 Modeling of Mitigative Sprays

The MELCOR containment spray model was used to calculate the thermal response of the fuel for the mitigated scenarios involving spray activation. The spray model mechanistically models the interaction of the spray droplets with the atmosphere and includes droplet heat and mass transfer and fission product removal capabilities. All calculations used a droplet size of 1,250 microns. The spray was positioned at the top of the SFP (elevation of the refueling bay), thus allowing the droplets to be directed into the assemblies and open spaces based on their respective cross-sectional areas.

The interphase momentum model, which replicates the Wallis flooding curve, controls the penetration of the spray water into the assembly. Once the spray water enters the assembly, the spray is assumed to form a thin film on the fuel structures in the assembly, which drains downward. The MELCOR simplified flow regime model identifies the spray flow as a film in contact with the fuel rods (see Figure 38). Heat transfer takes place between the fuel rods and water in core cells where the flow regime model is active. Nucleate or film boiling heats the water film to saturation conditions as it drains down the assembly. Simultaneous heat transfer from the rods and surrounding gas causes the spray flow to boil. The spray film travels downward in contact with the fuel rods until the local control volume void fraction becomes greater than 99.8 percent (i.e.,  $\alpha > 0.998$ ). Because of numerical considerations, the residual water is converted into a shallow pool where the liquid heat transfer area is apportioned by the depth of the pool in the control volume. Typically, the remaining water boils away in the first core cell after the flow regime model is disabled.

MELCOR thermal-hydraulic model interprets the liquid film as a small pool at the bottom of each control volume (see Figure 38). Because of the high void fraction, the phasic resistance of the steam or air flowing through the pool is relatively insignificant, which is the expected impact of a liquid film. Similarly, the depth of the spray water penetration is controlled by the heat transfer rate from the fuel rather than the momentum solution. Axial, stepwise heat transfer from the core cells limits how far the spray water penetrates into the assembly. A possible limitation of the thermal-hydraulic representation is the relatively small heat transfer area between the two phases (i.e., heat transfer through the pool and the surface versus a film). However, the rate of heat transfer from the gas to the water film is minor in comparison to the nucleate and film boiling heat transfer on the surface of the fuel rods. A detailed nodalization is used to track the water as it penetrates into the assembly which permits a better local representation of the fluid

conditions and the location of the spray dryout. Parametric calculations are performed to show the impact of this modeling parameter (i.e., flow regime model active or inactive as discussed in 6.3.1).



**Figure 38 Spray model for SFP analysis**

#### 6.1.4 Modeling of Fuel Collapse and Baseplate Failure

Fuel collapse is based on user-defined cumulative fuel damage fraction logic, in which the fuel failure time is defined as a function of cladding temperature and only applied if the unoxidized Zircaloy cladding thickness is less than 0.0001 m. The failure logic calculates the fuel damage fraction for the current timestep, if the unoxidized cladding thickness criteria are met, and adds that fractional damage to any previously calculated damage. When the cumulative fuel damage fraction exceeds unity, the fuel is failed in the SFP MELCOR model. This lifetime damage model eliminates the threshold behavior present in the other fuel failure criteria and predicts accumulating damage if the fuel remains above the melting temperature of Zircaloy and below the absolute threshold collapse criteria of 2500 K.

All components other than fuel rods (fuel and cladding) will be immediately converted to particulate debris whenever the unoxidized metal thickness is reduced below a user-defined minimum value. The minimum thickness criterion for the two MELCOR canister components is 0.0001 m. The unoxidized metal thickness is reduced both by oxidation and by melting and candling of metal. Molten Zircaloy held up by an oxide shell is released from the fuel rods at 2400 K and from the canister at 2100 K (i.e., just above the melting temperature of the Zircaloy). Particulate debris will be formed for canister components following the release of the molten Zircaloy or if the temperature of the component reaches the melting temperature of the associated oxide.

Baseplate failure is defined by the grid-supported or egg-crate plate model in MELCOR. In general, the beams that form the grid have sufficient strength that their failure is not an issue, and the interest is in failure of the web between them. Upon failure of the plate, the capability to support particulate debris or intact components is lost; however, the plate will remain in place until it melts. This model calculates baseplate failure based on the maximum stress in a plate of

user-defined thickness supported by beams of user-defined spacing with a total load on the area of the ring. In the SFP model, the thickness of the baseplate is defined as 0.0127 m with grid spacing of 0.07 m. The melting temperature of the plate is 1700 K.

### 6.1.5 Radionuclide Transport Modeling and Treatment of Hydrogen

In MELCOR, the RN package models the release and transport of fission product vapors and aerosols (referred to as radionuclides). Release of radionuclides can occur from the fuel-cladding gap by exceeding a failure temperature criterion or losing intact geometry or from material in the SFP using various empirical release correlations based on fuel temperatures. After release to a control volume, masses may exist as aerosols or vapors, depending on the vapor pressure of the radionuclide class and the volume temperature.

Aerosol dynamic processes and the condensation and evaporation of fission product vapors after release from fuel are considered within each control volume. Aerosols can deposit directly on surfaces and water pools or can agglomerate and eventually fall out by gravitational settling. Aerosols deposited on surfaces can be vaporized (if volatile) but cannot currently be resuspended in MELCOR. All deposition mechanisms are mechanistically modeled. Aerosols and vapors are transported between control volumes by bulk fluid flow of the atmosphere and the pool.

For tracking purposes, the radionuclides are combined into material classes, which are groups of elements (and their isotopes) with similar chemical and transport behavior. Radionuclide masses include both the radioactive and nonradioactive mass to properly model the transport of fission products. The SFP MELCOR model includes 15 default material classes and two user-defined classes to model the behavior of cesium iodide (CsI) and cesium molybdate ( $\text{Cs}_2\text{MoO}_4$ ), as shown in Table 23.

The fuel release model is based on the CORSOR-Booth model that more accurately predicts the release rates from the Phebus and VERCORS experiments (Gauntt, 2010). The default MELCOR radionuclide package input was modified to accommodate new insights from the Phebus experimental program. The cesium, iodine, and molybdenum radionuclide classes were reconfigured as follows:

- Class 4—Characteristic released compound is iodine with the default inventory wholly transferred to Class 16.
- Class 7—Characteristic released compound is molybdenum with the default inventory reduced by the amount allocated to Class 17.
- Class 16—Characteristic released compound is CsI with the default inventory representing all of Class 4 and sufficient cesium from Class 2 to form CsI.
- Class 17—Characteristic released compound is  $\text{Cs}_2\text{MoO}_4$  using the remainder of the cesium not in the gap (already included in Class 2) or not already combined with the iodine in Class 16. Sufficient molybdenum is included from Class 7 to Class 17 to form  $\text{Cs}_2\text{MoO}_4$ . The released vapor pressure and compound mass is consistent with  $\text{Cs}_2\text{MoO}_4$ .



Gauntt (2010) proposes an approach for the estimation of increased ruthenium release under air-oxidation conditions. Ruthenium (Class 6) has the lowest of vapor pressures in the default MELCOR model that prevents prediction of large releases.<sup>13</sup> There is evidence of higher volatility of ruthenium oxides (many orders of magnitude higher than the default MELCOR). It is assumed (Gauntt, 2010) that there is always air present leading to formation of a moderately hyperstoichiometric fuel ( $UO_{2.15}$ ) and release of ruthenium dioxide ( $RuO_2$ ). The default vapor pressure parameters in MELCOR are adjusted for the ruthenium class to match  $RuO_2$  vapor pressure at 2200 K.<sup>14</sup> The new ruthenium release model is applied only to scenarios involving rapid draindown (for moderate leak rates) of the SFP pool. These cases lead to relatively early clearing of the rack baseplate and flow of air (and possibly steam) through the assemblies. It should be noted that the model does not take into account the concentration of oxygen or steam during the oxidation process.

**Table 23 MELCOR Radionuclide Class Composition**

Class #	Class Name	Representative	Member Elements
1	Noble Gases	Xe	He, Ne, Ar, Kr, Xe, Rn, H, N
2	Alkali Metals	Cs	Li, Na, K, Rb, Cs, Fr, Cu
3	Alkaline Metals	Ba	Be, Mg, Ca, Sr, Ba, Ra, Es, Fm
4	Halogens	I	F, Cl, Br, I, At
5	Chalcogens	Te	O, S, Se, Te, Po
6	Platinoids	Ru	Ru, Rh, Pd, Re, Os, Ir, Pt, Au, Ni
7	Early Transition Elements	Mo	V, Cr, Fe, Co, Mn, Nb, Mo, Tc, Ta, W
8	Tetravalent	Ce	Ti, Zr, Hf, Ce, Th, Pa, Np, Pu, C
9	Trivalent	La	Al, Sc, Y, La, Ac, Pr, Nd, Pm, Sm, Eu, Gd, Tb, Dy, Ho, Er, Tm, Yb, Lu, Am, Cm, Bk, Cf
10	Uranium	U	U
11	More Volatile Main Group	Cd	Cd, Hg, Zn, As, Sb, Pb, Tl, Bi
12	Less Volatile Main Group	Sn	Ga, Ge, In, Sn, Ag
13	Boron	B	B, Si, P
14	Water	H <sub>2</sub> O	H <sub>2</sub> O
15	Concrete	-	-
16	Cesium Iodide	CsI	CsI
17	Cesium Molybdate	CS <sub>2</sub> MoO <sub>4</sub>	CS <sub>2</sub> MoO <sub>4</sub>

The gap inventory specified in Table 24 is based on NUREG-1465, "Accident Source Terms for Light-Water Nuclear Power Plants," issued February 1995 (NRC, 1995). However, NUREG-1465 states that, for accidents in which long-term cooling is maintained (e.g., postulated spent fuel handling accident), the gap release could be as low as 3 percent, and, in the unmitigated scenarios in this study, the fuel experiences prolonged high temperatures (and even failure in some instances). Therefore, the present work assumes that 5 percent applies to all scenarios.

<sup>13</sup> There is a mass transfer limitation to the release from the fuel.

<sup>14</sup> The rationale for an increased ruthenium class release is based only on increased vapor pressure and requires further experimental validation.

The decay heat calculation was based on security assessment analyses that used a decay heat program provided by the licensee. The decay heat power is calculated based on the discharge time and other parameters, such as the fuel burnup and power history. The utility provided the program and the appropriate input files for the SFP configuration after its last offload (i.e., September 2001) to perform decay heat calculations. Consequently, the decay heat power of every assembly was calculated as a function of time from reactor shutdown.<sup>15</sup> The decay heat and radionuclide package for MELCOR was conceived for reactor analysis. Therefore, all assemblies are assumed to have the same shutdown time. MELCOR calculates the initial fission product inventory from tables of inventories and specific decay power for 29 elemental groups. The elemental decay heat is normalized per unit of mass of the element and stored as a function of time after shutdown.

**Table 24 Radionuclides Gap Inventories**

Class #	Gap inventory	Class combination
1	5%	—
2	100%	Characteristic released compound is CsOH with the default inventory wholly representative of the cesium in the fuel gap except what is already included in Class 16. Required amount of cesium not in gap of Class 16 to yield a 5% total cesium gap inventory.
3	1%	—
5	5%	—
16	5%	5% of the Class 16 inventory to yield 5% of the total iodine inventory in the gap

Since SFP accident calculations involve fuel assemblies with multiple shutdown times, the following procedure was used to implement the batch-average decay heat results. First, the effective reactor operating power was estimated using SFP inventory burnup. The effective operating power was calculated as the total burnup of all assemblies in the SFP (gigawatt days per metric tons of uranium) divided by the average assembly metric tons of uranium and the total number of days of criticality. Based on the effective operating power, MELCOR calculates the specific time-dependent decay heat and mass inventory for each element. The aging time in the specific element decay heat tables is specified as the scenario time minus the shutdown time of the assemblies in the most recent offload. Next, the above results for element inventories (kilogram (kg)) times the specific element decay heat (watts per kilogram) at the scenario time are scaled to match the total SFP decay power. This scaling procedure addresses any limitations in the relatively long-term decay heat power in the MELCOR data base. Finally, inventory scaling coefficients are used to partition the decay heat amongst the various MELCOR rings. In summary, the batch-average decay heat is explicitly conserved but the fission product inventory is not properly scaled to account for differences in the various assembly discharge dates. A postprocessing routine is implemented that uses the MELCOR predicted release fractions along with actual inventories calculated for each batch.

<sup>15</sup> An interpolation scheme was used to calculate the individual assemblies decay power at different times relevant to this study (the error in interpolation is typically less than 1 percent). Since the number of old assemblies was increased by 60 (3,055 total in the pool), the decay heat for these assemblies was assumed to be an average of the older assemblies.

To accommodate consequence calculations using MACCS2, an extensive control system was written in the MELCOR input file that tracks the fission product releases from each ring<sup>16</sup> and the subsequent release to the environment. Time-dependent, nondimensional environmental release fractions are calculated for each batch (i.e., MELCOR ring) that can be multiplied by the specific batch fission product activities to evaluate the environmental source term. The following procedure was used to map the releases from MELCOR to MACCS2. MELCOR activity release for each isotope (e.g., m = Cs-137, Cs-134, Cs-136 for Class 2) is given by the following:

$$A_m(t) = \sum_{r=1}^6 [RF_{m,r}(t) \times A_{m,r}^0] \quad (9)$$

MACCS activity release is given by the following:

$$\tilde{A}_m(t) = \tilde{RF}(t) \times \sum_{r=1}^6 A_{m,r}^0 \quad (10)$$

where  $\tilde{RF}(t)$  is defined as:

$$\tilde{RF}(t) \times A_1^0 + \dots + \tilde{RF}(t) \times A_M^0 = \sum_{m=1}^M A_m(t) \quad (11)$$

$$\tilde{RF}(t) = \frac{\sum_{m=1}^M A_m(t)}{\sum_{m=1}^M A_m^0} = \frac{\sum_{m=1}^M A_m(t)}{\sum_{m=1}^M \sum_{r=1}^6 A_{m,r}^0} \quad (12)$$

Where

r = ring number (total 6 rings)

m = radionuclide {1:M} where M is the number of ORIGEN-S isotopes in each class

t = time since start of event

RF (t) = environmental release fraction (ring by ring from MELCOR)

$\tilde{RF}(t)$  = environmental release fraction (by radionuclide group for MACCS2)

A = released activity (Becquerel (Bq))

A<sup>0</sup> = initial inventory (Bq) from ORIGEN-S (69 isotopes for each MELCOR ring)

### Radionuclide Inventories

The radiological inventories and decay heat for assemblies in the SFP were calculated using information provided by the utility for all assemblies discharged to the pool through Cycle 18 (September 2011). The information included the assembly identification, design type, initial enrichment, discharge burnup, and discharge date. The analysis basis for the high-density SFP inventory was 3,055 assemblies, a number based on the pool capacity of 3,819 assemblies, reduced by 764 assemblies to accommodate a full core offload capability. Information on

<sup>16</sup> A ring is a collection of assemblies in the MELCOR radial nodalization.

assemblies discharged before Cycle 7 is not considered since the target pool inventory was achieved with the assemblies from Cycles 7 to 18.

Assembly depletion and decay calculations were performed using the ORIGEN code (Gauld et al., 2011), maintained within the SCALE nuclear safety analysis code system (Rearden et al., 2012). The nuclear cross-section libraries used for the burnup analysis of the assemblies were those distributed in SCALE 6.1. These libraries are developed using ENDF/B-V cross-sections and include representative 7x7, 8x8, 9x9, and 10x10 General Electric assembly designs (Ilas et al., 2006) used in the reference plant reactor. ORIGEN calculations performed using these libraries have been validated against experimental destructive assay measurements, and calorimeter measurements of assembly decay heat have been demonstrated in previous validation studies (Ilas and Gauld, 2008) to be accurate within plus or minus 2 percent.

For the burnup analysis, the irradiation and decay history for each of the 3,055 assemblies in the pool was simulated using ORIGEN and assembly-specific design and operating history data provided by the utility. Each assembly was decayed to a reference date corresponding to the end of Cycle 18, and the assembly inventories combined into analysis groups. The groups were then further decayed to calculate spent fuel assembly activities and decay heat power for analysis cooling times of 3.6, 3.9, 5.0, 13.1, 37.0, 107.0 and 383.0 days after shutdown of the reactor. The assemblies were grouped according to the cycle they were discharged:

- Group 1 (268 assemblies from Cycle 18)
- Group 2 (272 assemblies from Cycle 17)
- Group 3 (272 assemblies from Cycle 16)
- Group 4 (276 assemblies from Cycle 15)
- Group 5 (284 assemblies from Cycle 14)
- Group 6 (1,683 assemblies from Cycles 7 to 13)

This division of assemblies by group facilitated use of the data for an analysis of a low-density SFP configuration, whereby all assemblies with a cooling time greater than 5 years have been removed from the pool. For the present analysis, each offload was assumed to be 284 assemblies for modeling convenience and to avoid modifying the MELCOR model nodalization.<sup>17</sup> Therefore, the actual inventories from batches were scaled appropriately to correspond to the rings in the MELCOR nodalization. For example, for the low-density case, the Cycle 18 inventories were increased by 284/268 and the sum of Cycles 16 and 17 were scaled as 568/(272 + 272), resulting in 852 assemblies as opposed to the actual 812.

The SFP results were compiled for each assembly group and all decay times and included activities (Bq) for 69 radionuclides and decay heat.<sup>18</sup>

Results from the present analysis were compared with those generated previously for the reference plant pool using assembly data provided by the utility through 2001 as part of the security assessment work. A limitation of the 2001 data was that the utility did not provide the actual discharged burnup distribution of assemblies from Cycles 12 and 13. Consequently, previous analyses assumed burnup distributions for these cycles based on data from Cycles 10 and 11. Review of the actual burnup distributions included in the 2011 data indicates that the

---

<sup>17</sup> The nodalization was based on the security assessment work. The additional data on later cycles were received after the MELCOR model had been developed and the calculations were started.

<sup>18</sup> The decay heat in the present analysis is based on the past security assessment work.

average discharge burnup increased significantly after Cycle 12. The burnup values used in the present analysis are significantly higher and therefore more representative of modern SFP inventories than earlier analyses. Previous analyses using the 2001 data are representative of discharged fuel up to about 1995.

Other differences are attributed to the specific power of the assemblies which influences the decay heat power and activities of short-lived fission products in the analysis time range. The utility did not provide information on the specific power. Notwithstanding power uprates for the reference plant reactor, the most recent occurring in 2002, the specific power used to calculate inventories for the assemblies in the present analysis was lower than that assumed using the earlier 2001 data. The present analysis normalized the average specific power of the discharged assemblies to the reactor specific power. Previous information provided by the utility in the 2001 data included the effective full-power days used to derive slightly higher specific power values compared to those used in the present study.

The net impact of differences between the analyses performed using 2001 data and the present analysis is an increase in the inventories for cooling times longer than about 30 days, attributed to higher assembly burnup in the 2011 data. For shorter cooling times the previous analyses predicted decay heat rates about 5 percent larger than the current results, likely the result of more conservative estimates of specific power used in the previous analyses. A comparison of the present decay heat results with values calculated by the utility in 2001 show agreement to better than 3 percent over all cooling times, with present results slightly larger than utility values, most likely because of the increase in discharge burnup since 2001.

### Hydrogen Burn

A burn is initiated in a control volume if the mole fraction of the reactants (hydrogen and oxygen) satisfies the burn criteria. In addition, control volumes that are specified to contain igniters are tested against different criteria than control volumes without igniters. In an SFP calculation, ignition is assumed to occur in the reactor building when the hydrogen concentration exceeds 10 percent by volume. In addition, MELCOR checks to determine whether there is sufficient oxygen. The minimum oxygen mole fraction for ignition is 5 percent. The maximum diluents mole fraction for ignition (mole fraction of steam plus mole fraction of carbon dioxide) is 55 percent. If all of these conditions are satisfied, a burn is initiated. Some uncertainty may exist regarding the combustion of hydrogen, especially with regard to the timing of a spontaneous ignition. A hydrogen burn may occur at higher or lower concentrations of hydrogen, air, and steam that have both epistemic and aleatory uncertainties. Many SFP calculations resulted in conditions in which combustion was very likely or very unlikely. Consequently, the SFPS presents the results of cases with and without combustion. However, some cases have conditions in which the occurrence or timing of a combustion event has more uncertainty; these cases were assumed to ignite or not ignite according to the default spontaneous combustion criteria in MELCOR (see Section 9.1). Once a burn is initiated, it can propagate to other control volumes using the default hydrogen concentrations of 4 percent, 6 percent, and 9 percent for upward, horizontal, and downward propagations, respectively.

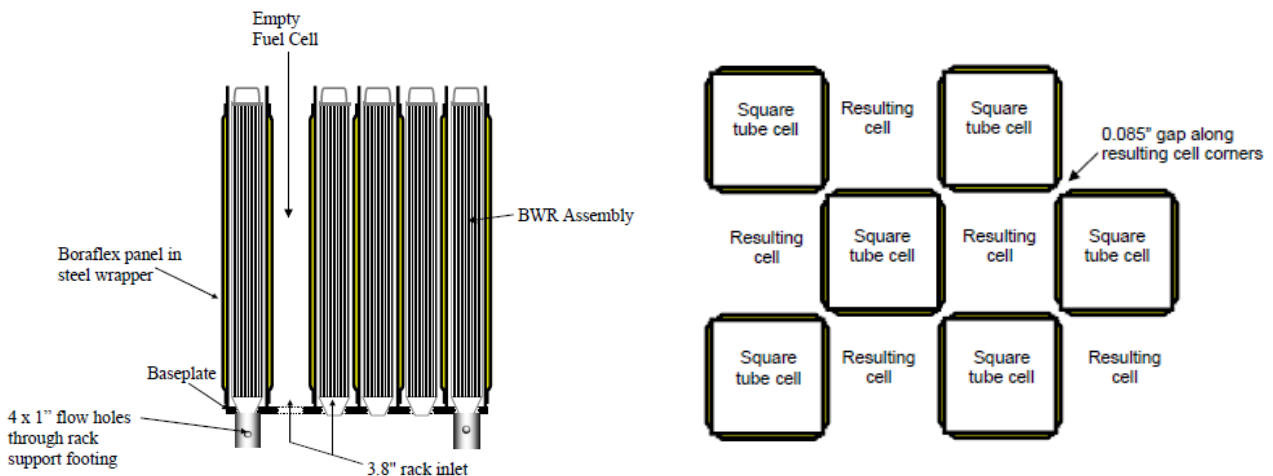
## **6.2 Description of MELCOR Models**

The SFP, 40 ft (12.2 m) wide by 35.3 ft (10.8 m) long by 38.75 ft (11.8 m) deep, is located on the refueling floor of the reactor building. The pool is constructed of reinforced concrete with a wall and floor lining of 1/4-in.- (0.63-cm-) thick stainless steel. The walls and the floor of the

SFP are approximately 6 ft (1.83 m) thick. In the northeast corner of the SFP is a cask area that is 10 square feet (ft<sup>2</sup>) (0.93 square meter (m<sup>2</sup>)).

The high-density SFP racks provide spent fuel storage at the bottom of the fuel pool. The fuel storage racks are normally covered with about 23 ft (7 m) of water for radiation shielding. The SFP racks are freestanding, full length, and top entry and are designed to maintain the spent fuel in a spaced geometry that precludes the possibility of criticality. The high-density SFP racks are of the “poison” type utilizing a neutron-absorbing material to maintain a subcritical fuel array. The racks are rectilinear in shape and are of nine different sizes. A total of 3,819 storage locations are provided in the pool. The racks are constructed of stainless steel materials, and each rack module is composed of cell assemblies, a baseplate, and base support assemblies. Each cell is composed of (1) a full-length enclosure constructed of 0.075-in.- (0.2-cm-) thick stainless steel, (2) sections of Bisco Boraflex, which is a neutron-absorbing material, and (3) wrapper plates constructed of 0.020-in.- (0.05-cm-) thick stainless steel. The inside square dimension of a cell enclosure is 6.07 in. (0.15 m). The cell pitch is 6.28 in. (0.16 m). The baseplate is made from 0.5-in.- (1.27-cm-) thick stainless steel with 3.8 in. (0.1 m) chamfered through-holes centered at each storage location, which provides a seating surface for the fuel assemblies. These holes also provide passage for coolant flow.

Each rack module has base support assemblies (i.e., “rack feet”) located at the center of the corner cells within the module and at interior locations to distribute the pool floor loading (see Figure 39). Each base assembly is composed of a level block assembly, a leveling screw, and a support pad. The top of the leveling block assembly is welded to the bottom of the base plate. SFP fuel cells are located above each rack foot. Four 1-in. holes are drilled into the side of the support pad. The interior of the support pad is hollow and permits flow to the opening in the base plate. The square tube cells are used to construct the rack cells, which results in an equal number of cells resulting from the square tube cell checkerboard layout. Figure 39 shows the layout of the rack cells. There is the potential for lateral cell-to-cell flow between connected rack cells.

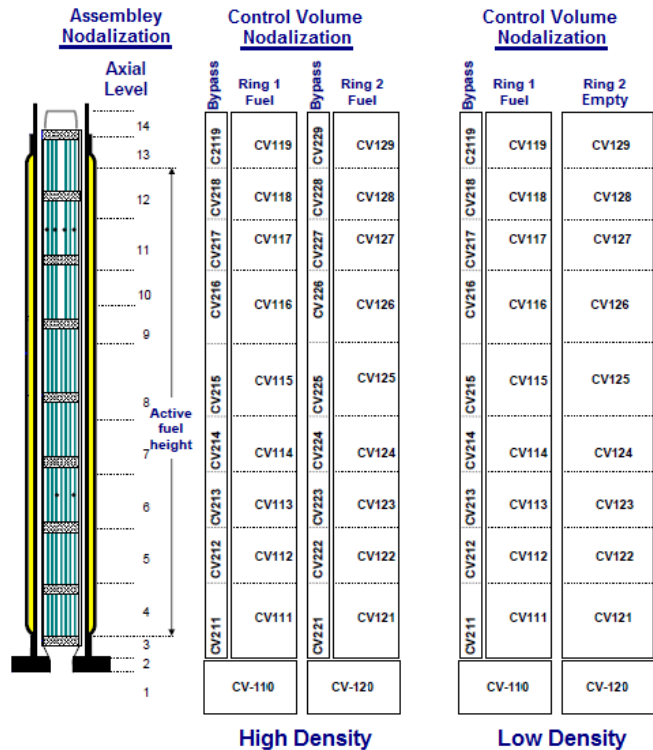


**Figure 39 Typical SFP rack cut away cross sections**

Figure 40 shows the control volume nodalization of the SFP region of the whole pool model. The bottom of the pool was divided into eight regions. CV299 represents all open regions in the SFP around the racks, including the cask area. The racks are subdivided into the other seven







**Figure 41 MELCOR nodalization of the assemblies (only two rings shown)**

The hydraulic resistance was specified using the results from the SNL experimental test program (Durbin, 2005).<sup>19</sup> For example, for the flowpath connecting CV113 and CV114 in the fully populated region, the MELCOR input values included a form loss coefficient of 3.8, and a friction factor ( $S_{LAM}$ ) of 31.3 (equal to 125/4 since MELCOR uses the fanning friction factor definition). The flow resistance under the racks was represented using typical contraction inertial loss coefficients and viscous losses consistent with a flow length to the center of the SFP. The BWR assembly canister is modeled with the MELCOR canister component. The rack walls are modeled with the new rack component with stainless steel and Boraflex materials. MELCOR does not include an option to model the two large water rods in the center of the assembly. Consequently, the water rod mass and surface area was included in the canister wall.

The axial channel and bypass wall blockage models were active and controlled the resistance in the respective flowpaths. The blockage model monitors the porosity of the materials in the channel and bypass regions. If a debris bed forms, the flow resistance is adjusted via an Ergun flow resistance model. The canister wall radial blockage model controls flowpaths between the bypass region and the assembly. Initially, the canister wall precludes flow. However, if the canister fails, a radial flowpath is activated that permits flow between the two regions. Similar to the axial blockage model, the flow resistance is adjusted based on the local debris porosity.

<sup>19</sup> In the present study, the assembly nodalization is based on the GE14C 10x10 configuration (NRC, 2012) to account for the latest offloads used in the low-density configuration. Both 9x9 and 10x10 configurations have partial fuel rods. The flow area for each assembly is reduced by about 4 percent compared to the 9x9 design. The hydraulic resistance data are assumed to apply. The frictional loss coefficient for a 10x10 array could be somewhat different since it is a function of hydraulic diameter and grid spaces design.



A complete reactor building has been developed for the reference plant (NRC, 2012d). However, the bulk of the reactor building does not play a significant role in SFP accidents, given that the study does not explicitly model (1) the effect of the SFP accident on reactor systems or (2) specific obstacles to deploying mitigation (e.g., presence of steam on lower elevations). Consequently, the reactor building model was simplified to only model the refueling room (i.e., within the red dashed line in Figure 42).

A single control volume models the refueling bay. An open hatch in the southeast quadrant connects (via a flowpath) the refueling room to a boundary condition volume representing the flow connection to the lower sections of the building. The nominal reactor building leakage is modeled at the center elevation of the refueling bay, and the leakage flow from elevations in the simplified model from the lower regions was tuned to match the leakage flow rate of a detailed reactor building model.

The detailed reactor building model simulated many overpressure failure flowpaths within the reactor building. The simplified refueling floor model included the two most important flowpaths—(1) the blowout panels on the refueling room walls and (2) a pathway representing the structural failure of the reactor building roof. The refueling room blowout panels will fail if there is an overpressure greater than 1,720 pascal (Pa) (0.25 pounds per square inch gauge (psig)). If the reactor building pressure rises above 3,450 Pa (0.5 psig), failure of the roof decking will occur.

MELCOR does not include models for stratification of hot gases. Each control volume is assumed to be well mixed and have a single temperature. Large-scale natural circulation flow patterns can be predicted when the bulk temperature differences between adjacent rooms create mixing flows. However, it would be awkward or perhaps impossible to predict complex plume behavior within regions typically modeled with a single control volume (e.g., the room above the SFP). Consequently, the MELCOR calculations are expected to overpredict the amount of thermal mixing within the building. Based on insights from the computational fluid dynamics calculations for the security assessment work, the MELCOR refueling room model nodalization included modeling features to minimize excessive mixing. The refueling room is modeled as a single control volume. However, the inlet flow into the SFP (i.e., CV301 in Figure 40) comes directly from the hatch region (see left side of Figure 42). In this manner, the cool gases leaving the lower regions of the building are not brought into thermal equilibrium with gases above the SFP. Cross-flow is simulated between CV300 and CV301 as observed in the computational fluid dynamics calculations.

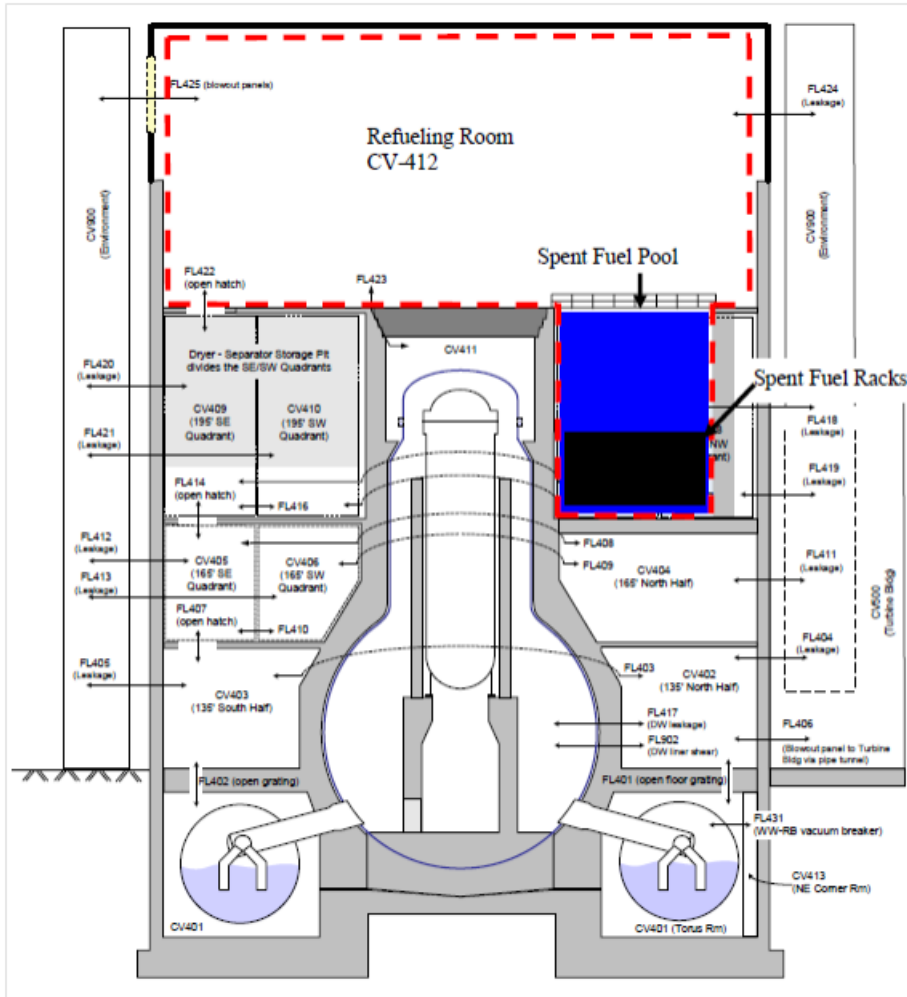
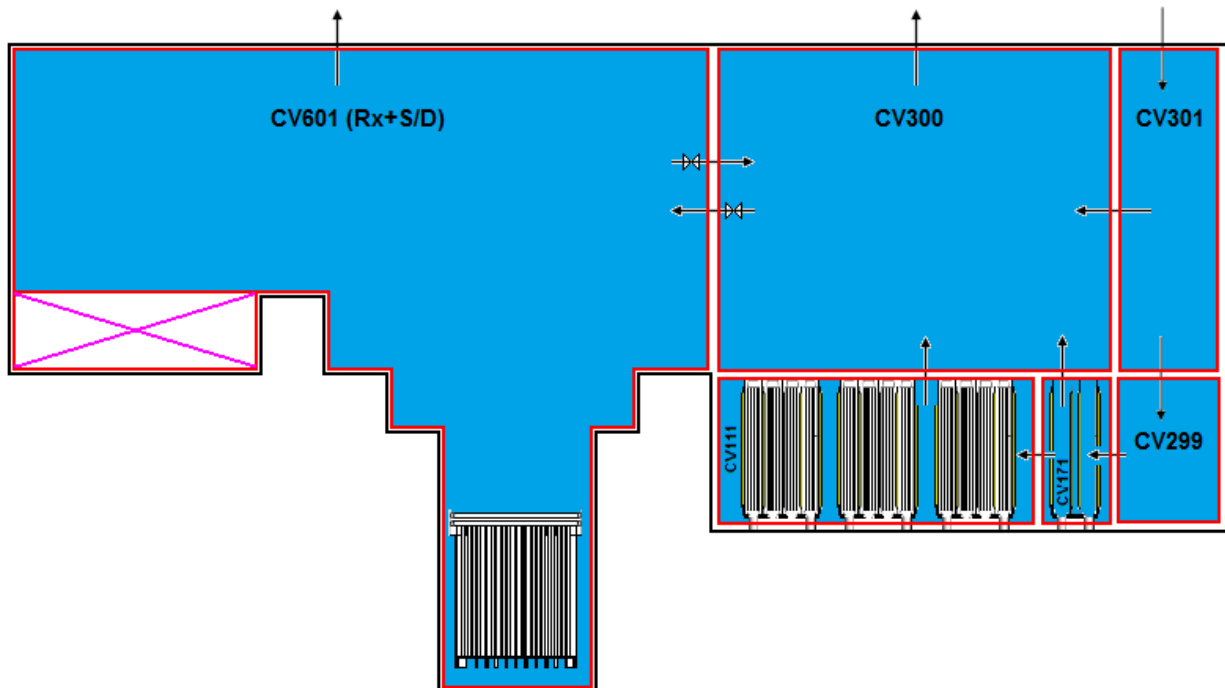


Figure 42 MELCOR reactor building model

### 6.2.1 High-Density Loading during Outage

During an outage in which the SFP and reactor are hydraulically connected, a single control volume is used to represent both the reactor well and separator/dryer pool, as shown in Figure 43. The total volume of pool in CV601 is about 1,900 m<sup>3</sup> (neglecting the dead-end pool volume of 243 m<sup>3</sup> below the separator/dryer gate elevation). CV601 is hydraulically connected to CV300 (see Figure 40) using two flowpaths until the water level reaches the SFP gate and no more water can flow into the SFP. The reactor power is applied as an external energy source until the pools become disconnected. The total additional volume of water above the SFP gate is about 1,400 m<sup>3</sup>.



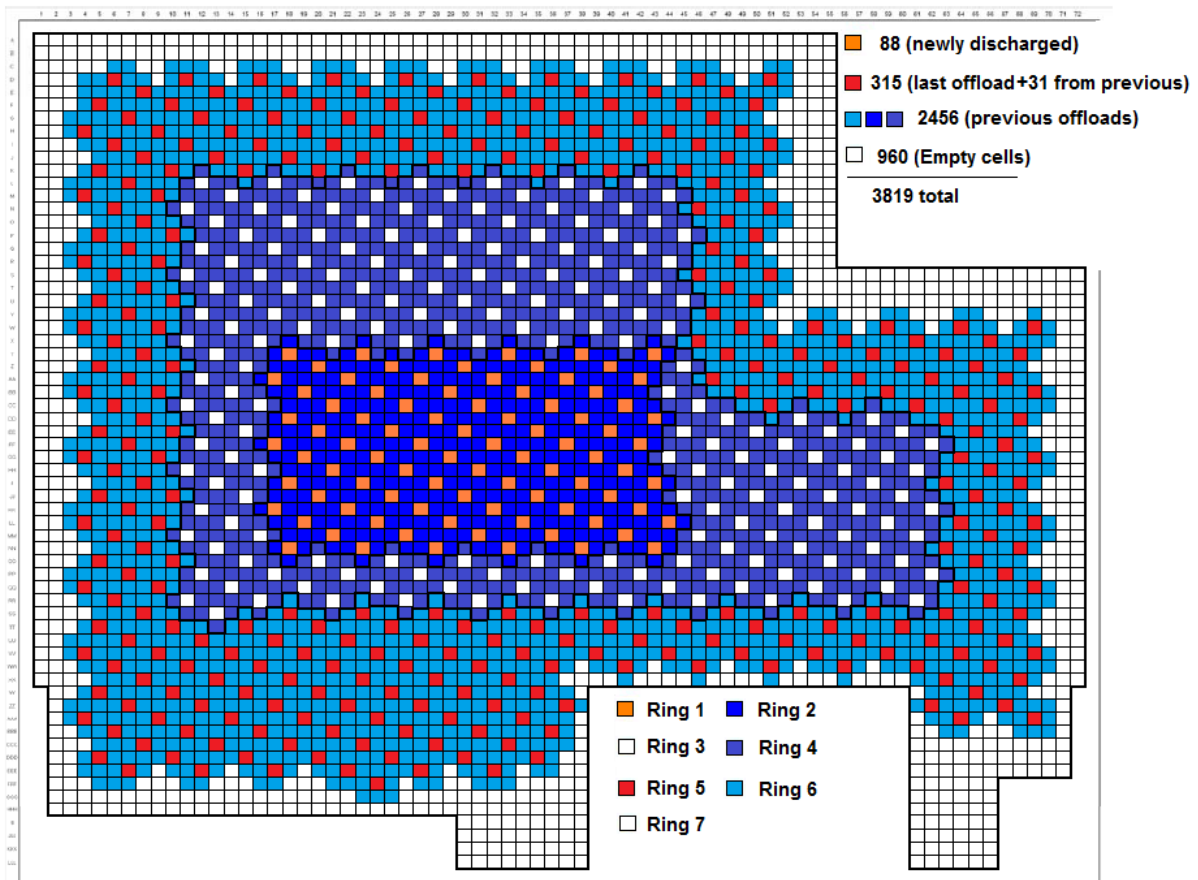
**Figure 43 SFP and reactor connection model during outage**

For both OCP1 (at 4 days) and OCP2 (at 13 days), CV601 is connected to the detailed model of the SFP (

Figure 40). Figure 44 shows the assembly layout for OCP1 in a 1x4 pattern in which the assemblies are grouped into six types or “rings” by decay heat power and time of discharge. The 88 assemblies from the most recent offload in Ring 1 are surrounded by 352 old assemblies in Ring 2.<sup>20</sup> Ring 3 is empty during the outage where the assemblies still reside in the reactor.<sup>21</sup> Ring 5 contains the last offload (284 assemblies) with an additional 31 assemblies from previous offloads. Rings 2, 4, and 6 have a total of 2,456 assemblies with their total decay heat distributed in each ring scaled by the number of assemblies. Within each MELCOR ring, the assembly decay heat is uniform. Consequently, for any given scenario, the decay heat in each ring is adjusted to give the average assembly power. Finally, the 764 empty cells in Ring 7 were placed around the outside of the SFP, which promotes open air downflow into the SFP in the event of a complete loss-of-coolant inventory accident. The empty cells (764 in Ring 7 and 196 in Ring 3) have no decay heat. For the empty cells in Ring 3, the axial nodalization is detailed (see Figure 41) without the bypass control volume. This will ensure a better representation of flow through the assemblies and modeling of heat transfer between components in various rings.

<sup>20</sup> All of the old assemblies are smeared in MELCOR Rings 2, 4, and 6 (i.e., decay power per assembly is the same).

<sup>21</sup> The decay power for the Ring 3 assemblies is added to the CV601 external power. Therefore, OCP1 has less power in the SFP since the 196 Ring 3 assemblies have not been moved yet.



**Figure 44 Layout of assemblies for OCP1 high density (1x4) model**

Figure 45 shows the cell-wall radiation view factors between the various rings.<sup>22</sup> The resultant view factor specifies the amount of coupling from each region to another. For example, the Ring 1 cells are completely surrounded by Ring 2 cells. Hence, the view factor from Ring 1 to Ring 2 is 1.0. Similarly, Rings 3 and 4 and Rings 5 and 6 are coupled in 1x4 patterns. Using the specific layout in Figure 44, the special MELCOR generalized radiative heat transfer coupling model was prescribed to represent the thermal coupling between Rings 2 and 4, Rings 4 and 6, Rings 6 and 7, and Ring 7 and the SFP wall. The radial coupling for these regions was specified as the product of the area (i.e., represented as the number of coupling panels) times the view factor.<sup>23</sup> In OCP2, the 196 assemblies have been moved to Ring 3, as shown in Figure 46, and the radial thermal coupling is preserved as in Figure 45.

<sup>22</sup> MELCOR models intracell radiation between concentric rings by default. To disable the radiation model for Rings 2 to 3 and 4 to 5, the radial view factor area is set to zero.

<sup>23</sup> The view factor is assumed to be unity. It should be noted that there is a temperature gradient within each ring, and MELCOR attempts to model a multidimensional geometry with a simplified two-surface radiation model.

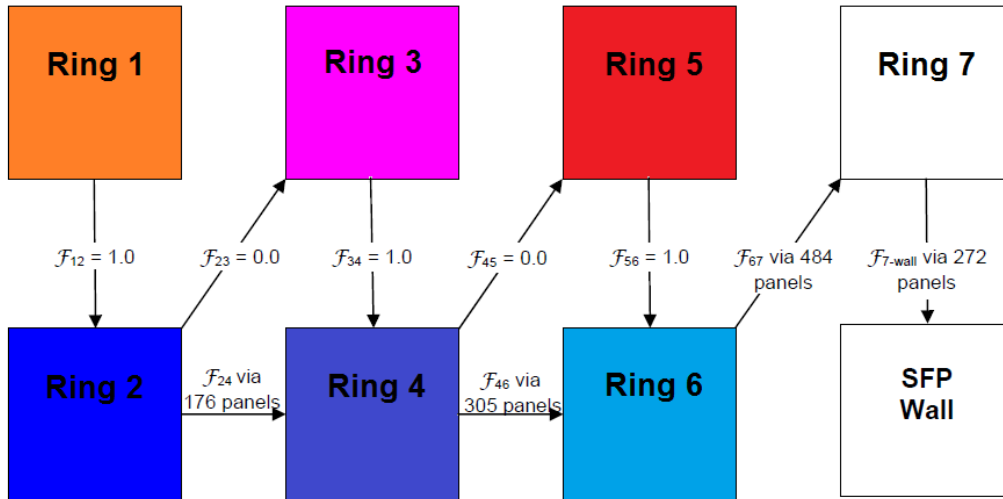


Figure 45 MELCOR radial radiative coupling scheme

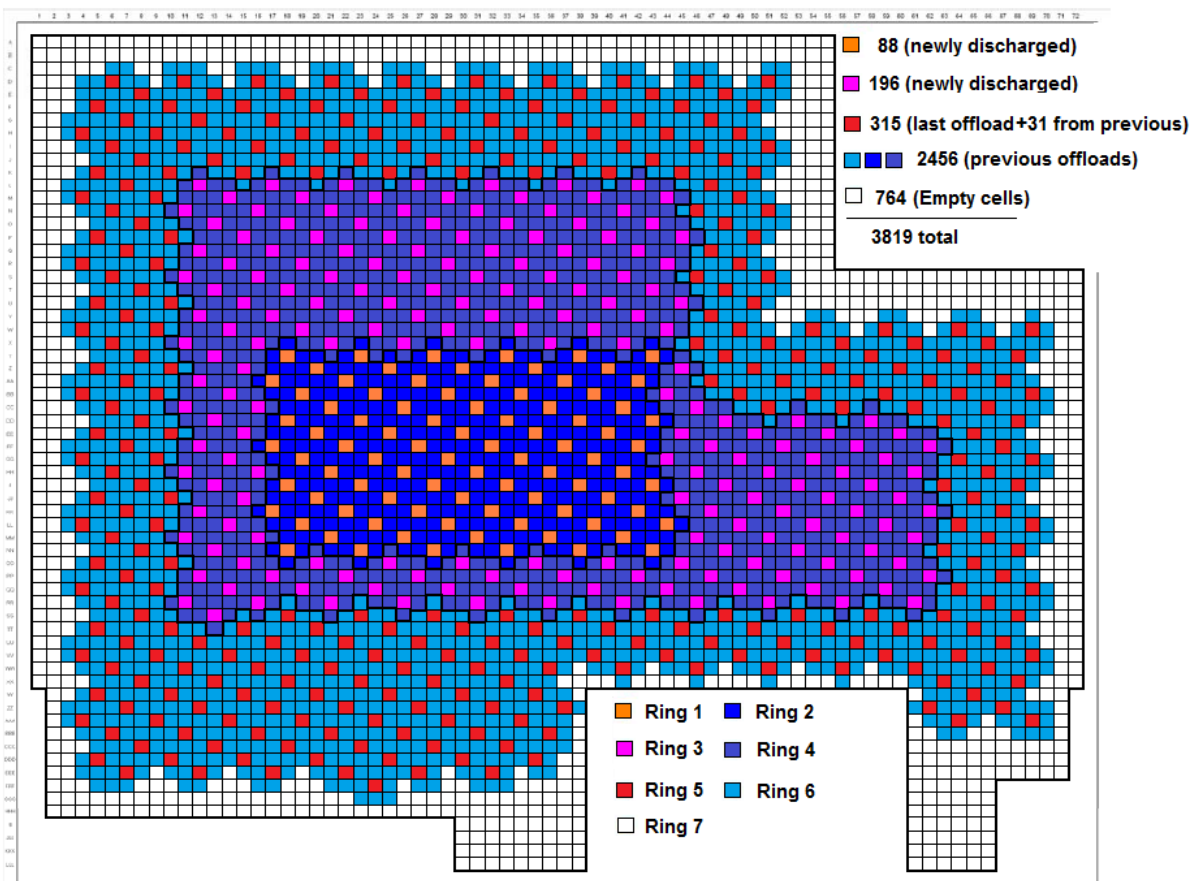


Figure 46 Layout of assemblies for OCP2 high-density (1x4) model

The methodology described in Section 6.1.5 was used to estimate the decay heat power as a function of time for different OCPs. Table 25 shows the results of this analysis. The reactor power was based on the decay power for all assemblies residing in the reference plant reactor (NRC, 2012d) by subtracting the power associated with assemblies that have already been

moved to the SFP. For example, for OCP1, the analysis assumed that 88 assemblies are already in the SFP.

**Table 25 Distribution of Decay Heat in the Reactor and SFP for High Density Loading**

	Reactor (kW)	Spent Fuel Pool (kW)							
		Days	Ring 1 (88) <sup>1</sup>	Ring 3 (0)	Ring 5 (315)	Ring 2 (352)	Ring 4 (784)	Ring 6 (1,320)	Total (2,859)
OCP1	10,216	3.6	1,927	0	465	80	179	301	2,951
	9,915	3.9	1,867	0	452	80	179	301	2,878
	9,006	5.0	1,690	0	417	80	178	300	2,666
	7,406	8.0	1,403	0	358	80	178	300	2,320
	6,710	10.0	1,282	0	334	80	178	300	2,174
		Days	Ring 1 (88)	Ring 3 (196)	Ring 5 (315)	Ring 2 (352)	Ring 4 (784)	Ring 6 (1,320)	Total (3,055)
OCP2	4,395	13.1	1,144	1,533	332	80	178	300	3,567
	4,117	15.0	1,077	1,444	330	80	178	299	3,409
	3,530	20.0	957	1,294	318	79	176	296	3,120
		Days	Ring 1 (88)	Ring 3 (196)	Ring 5 (315)	Ring 2 (352)	Ring 4 (784)	Ring 6 (1,320)	Total (3,055)
OCP3		37	720	973	324	79	177	298	2,571
OCP4		107	422	602	301	78	173	292	1,868
OCP5		383	191	315	230	73	162	273	1,245

1. The numbers in parentheses are the number of assemblies.

### 6.2.2 High-Density Loading Postoutage

The layout for the postoutage high-density loading is similar to OCP2 (see Figure 46). In postoutage, the assemblies are assumed to be in a 1x4 pattern, which applies to OCP3, OCP4, and OCP5. The assembly layout remained constant for these OCPs. However, the decay heat decreased from OCP3 to OCP5 as the aging time since reactor shutdown increased. Table 25 summarizes the decay heat power in each ring.

### 6.2.3 Low-Density Loading during Outage

For the low-density loading configuration, only the latest and the previous two offloads are considered. Therefore, for OCP2, the total number of assemblies in the pool is 852 (equal to  $284 \times 3$ ). For OCP1, the 196 assemblies from the current offload are still in the reactor and only 88 have been moved, resulting in only 656 assemblies in the pool. Figure 47 shows the layout of assemblies in the SFP for OCP1, and Figure 48 shows the layout for OCP2. For both configurations, all of the old fuel has been removed from the pool, and the current offload is in a 1x4 pattern with empties. Because of space limitations, the last two offloads are placed in a checkerboard pattern.<sup>24</sup> For the axial nodalization, Ring 1 contains both the channel (inside the

<sup>24</sup> There is not enough room to place all of the fuel in a 1x4 pattern. The current offload eventually requires 1,420 cells (284 for assemblies and  $284 \times 4$  for empties surrounding them), which would leave only 1,635 cells (excluding Ring 7). The 568 assemblies would require 2,840 cells for storage in a 1x4 pattern.

canister) and the bypass (outside between canister and rack) control volumes, while both volumes are combined for Ring 2 (see Figure 41). The basic radial thermal coupling from Figure 45 still applies, but the boundary area from Ring 6 to Ring 7 is 472 panels. For modeling convenience, Rings 2, 4, and 6 from the high-density layout are still present, but the cells contain only the rack component.

Table 26 provides the distribution of decay heat in the pool. A comparison with the high-density decay heat shows that the total decay heat in the pool for the low-density case is reduced by less than 20 percent. The total pool decay heat is dominated by the last offload, which is the same for the low- and high-density configurations. However, removing the old fuel also increases the available water volume (not occupied by the fuel and canister), while at the same time modifying the propagation characteristic of zirconium fire because of reduced mass in the empty assemblies.

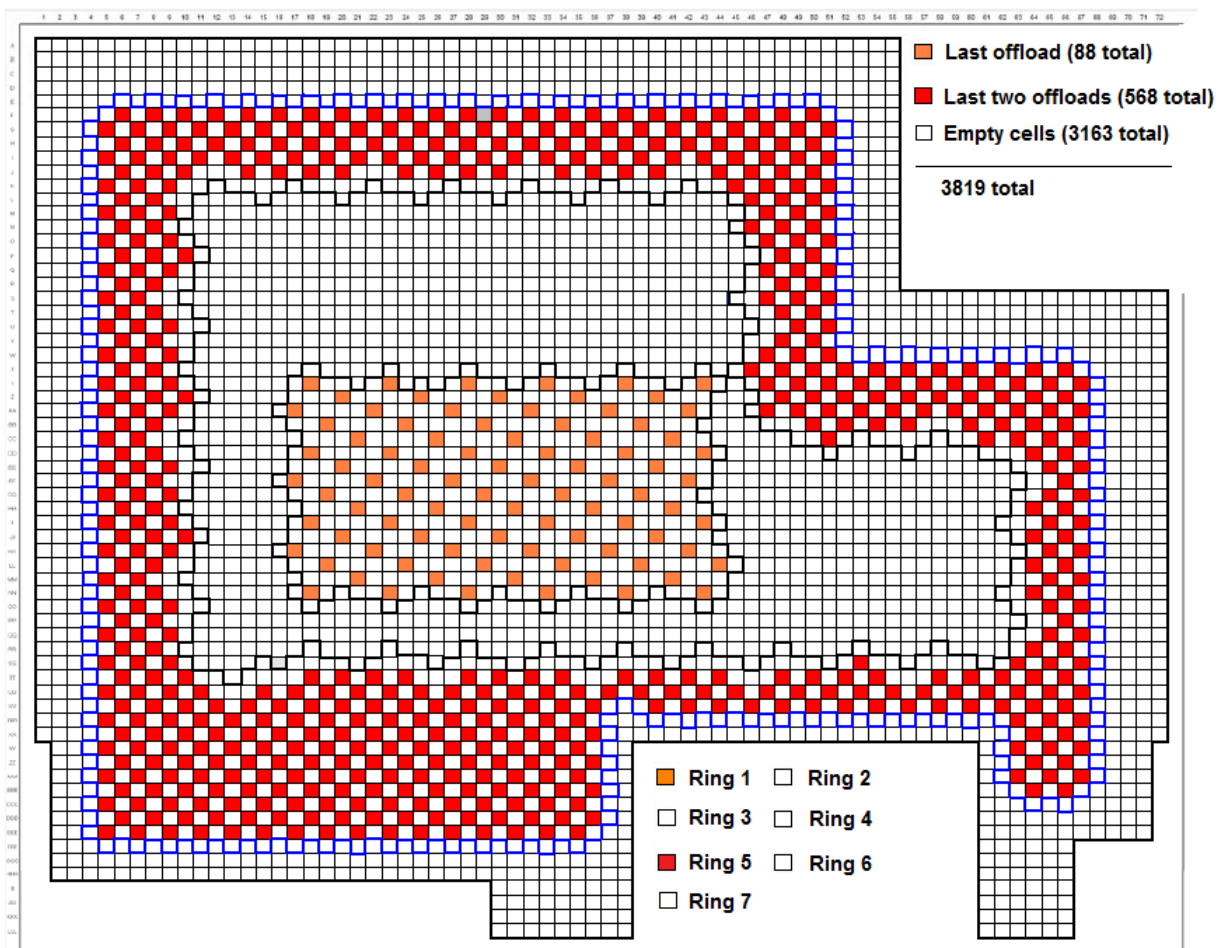


Figure 47 Layout of assemblies for OCP1 low-density model

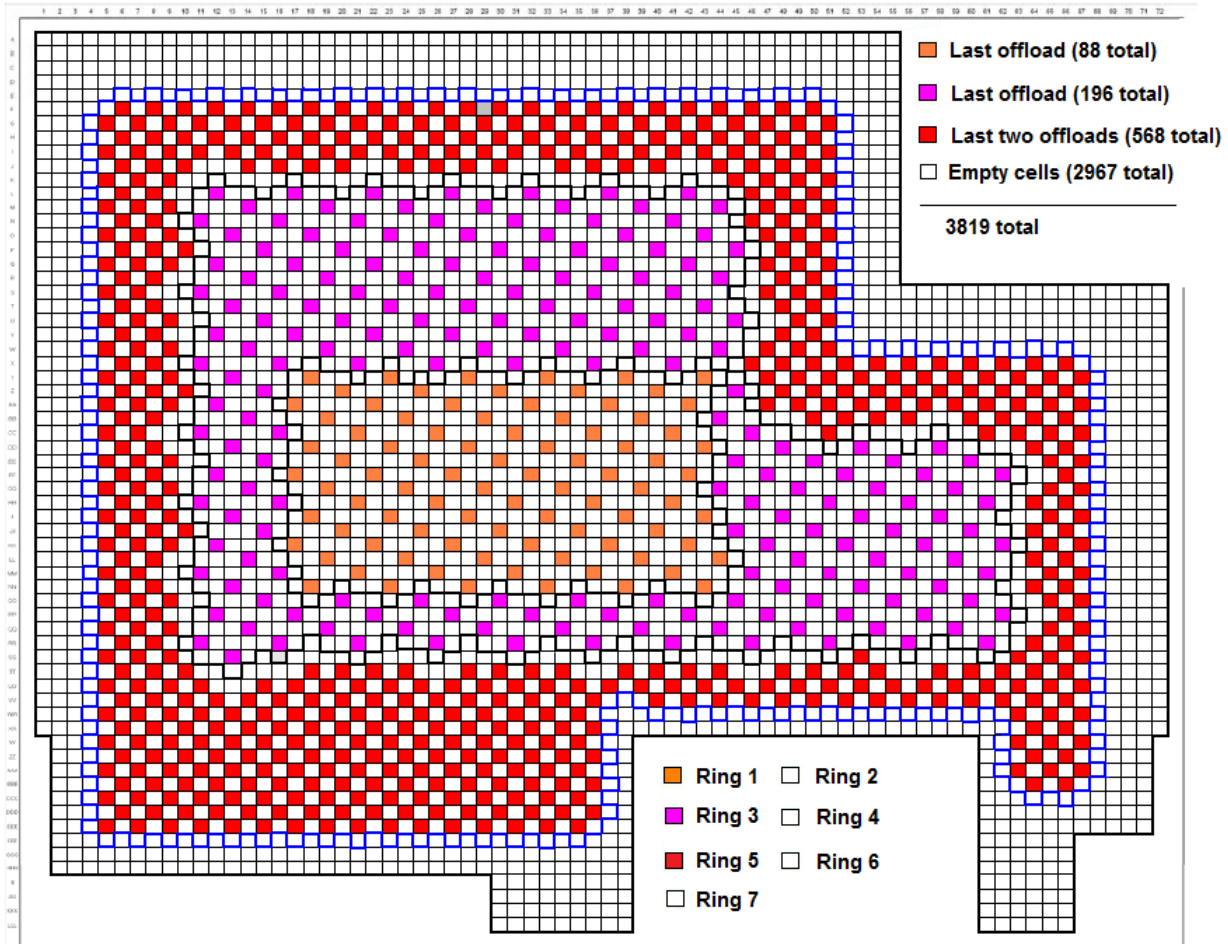


Figure 48 Layout of assemblies for OCP2 low-density model

#### 6.2.4 Low-Density Loading Postoutage

The postoutage low-density layout for OCP3, OCP4, and OCP5 is identical to OCP2 (see Figure 48), and the pool decay heat is provided in Table 26.



**Table 26 Distribution of Decay Heat in the Reactor and SFP for Low Density Loading**

	Reactor (kW)	Spent Fuel Pool (kW)							
		Days	Ring 1 (88)	Ring 3 (0)	Ring 5 (568)	Ring 2 (0)	Ring 4 (0)	Ring 6 (0)	Total (656)
OCP1	10,216	3.6	1,927	0	599	0	0	0	2,526
	9,915	3.9	1,867	0	587	0	0	0	2,454
	9,006	5.0	1,690	0	551	0	0	0	2,241
	7,406	8.0	1,403	0	492	0	0	0	1,895
	6,710	10.0	1,282	0	468	0	0	0	1,750
		Days	Ring 1 (88)	Ring 3 (196)	Ring 5 (568)	Ring 2 (0)	Ring 4 (0)	Ring 6 (0)	Total (852)
OCP2	4,395	13.1	1,144	1,533	466	0	0	0	3,143
	4,117	15.0	1,077	1,444	464	0	0	0	2,985
	3,530	20.0	957	1,294	448	0	0	0	2,699
		Days	Ring 1 (88)	Ring 3 (196)	Ring 5 (568)	Ring 2 (0)	Ring 4 (0)	Ring 6 (0)	Total (852)
OCP3		37	720	973	455	0	0	0	2,149
OCP4		107	422	602	427	0	0	0	1,451
OCP5		383	191	315	339	0	0	0	845

### 6.3 MELCOR Analysis Results

#### 6.3.1 Sequences That Do Not Lead to a Release

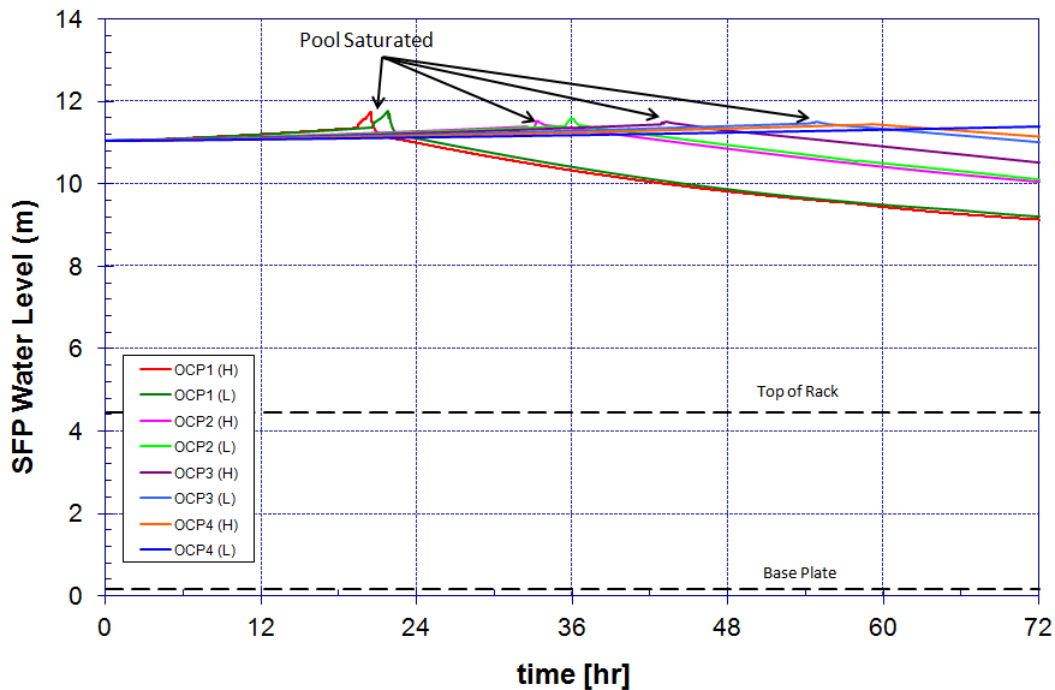
In general, the following four classes of scenarios do not result in a release from the fuel:

1. boiloff scenarios with no SFP leaks
2. mitigated scenarios for small leaks
3. unmitigated scenarios in late phases (OCP4, OCP5)
4. mitigated moderate leak scenarios in OCP2, OCP3, OCP4, and OCP5

#### Boiloff

For the boiloff scenarios, a simplified model was used to estimate the pool heatup and water level drop. Figure 43 shows this model in which all of the assemblies are combined in two rings representing the fuel and empty cells. Only the thermal-hydraulic models in MELCOR are active, and the power for both the reactor well pool and SFP are provided as external sources to the water pool. The results are considered conservative since the heat capacities of the assemblies are not taken into account. The time-dependent power is taken from Table 25 for high-density cases or Table 26 for low-density cases. The top of the pool is connected to the reactor building (see Figure 42) in the same manner as in the detailed model. This simplified model is used as a screening tool to determine whether more detailed analysis is needed. Figure 49 shows the water level as a function of time for both high- and low-density cases for

OCP1, OCP2, OCP3, and OCP4.<sup>25</sup> Figure 49 also identifies the time required to reach pool saturation. For cases in the same OCP, the high-density cases become saturated sooner since there is less water volume and more decay heat. In the late OCPs following refueling, the difference in the timing directly correlates to the decay heat power. While there are differences in postsaturation water level for OCP3 and OCP4, the water level for OCP1 and OCP2 is similar as a result of mixing assumed between the reactor well water and the SFP water (see Figure 43). For the OCP4 low-density and OCP5 cases, the SFP never becomes saturated in 72 hours. The slight water level increase during the sensible heating period results from the change in pool density as the water heats up. The analysis shows that there is 4.6 m (15 ft) of water above the top of racks in OCP1 at 72 hours.



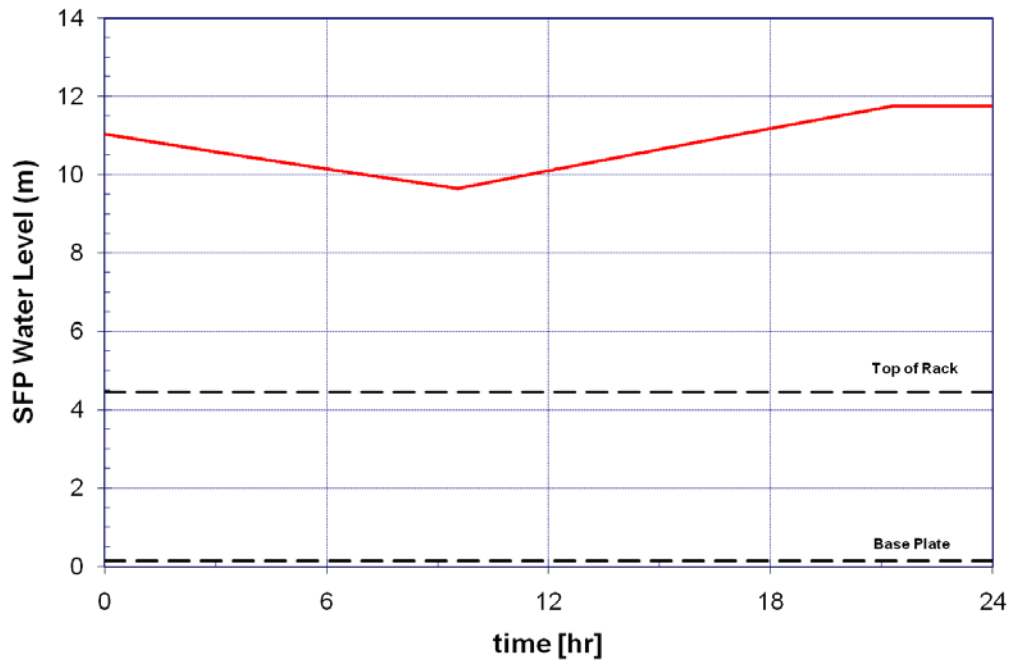
**Figure 49 Water level for boiloff scenarios**

Mitigated Scenarios (Small Leaks)

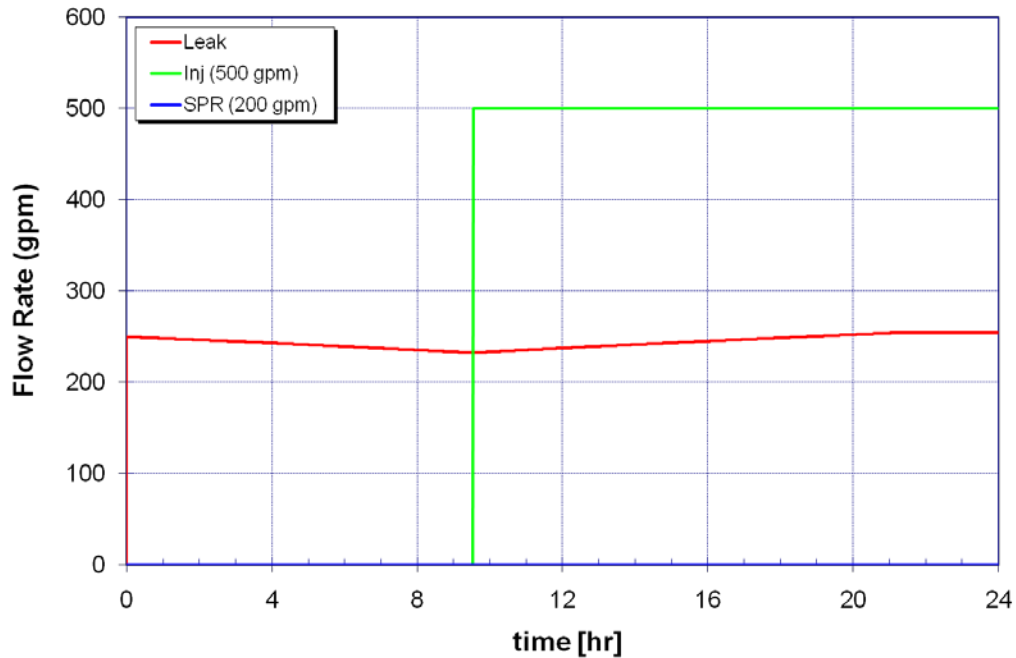
The small leak is modeled in MELCOR with a 4.4 cm (1.75-in.) diameter hole at the bottom of the pool based on the structural analysis and damage to the pool (effective size of cracks in the liner and the concrete). Figure 50 and Figure 51, respectively, show the water level and the injection and leak mass flow rates for the low-density OCP1 case. Once the water level reaches 10 m at about 7 hours, the leak is detected and, together with the deployment logic, the water injection begins at about 9.5 hours. In this case, mitigation is direct makeup to the pool

<sup>25</sup> The initial water level is assumed to be 11 m. The initial water temperature is 82 degrees F (28 degrees C). Both these initial conditions are applied to all accident scenarios in this report. Based on a teleconference with the licensee held on April 24, 2012, this is the postoutage water temperature under steady-state conditions where the heat exchangers are working (prior to postulated accident). During an outage (OCP1 and OCP2), the water temperature could vary between approximately 80 degrees F and 100 degrees F. The higher temperature affects the sensible heating of the pool and is not expected to change the overall conclusion of boiloff scenarios given the significant margin observed.

(injection) since the water level at the time of deployment is more than 1 m above the top of the racks. For this small leak, the initial water flow rate is about 250 gpm (0.016 cubic meters per second ( $m^3/s$ )), which is much lower than the makeup capacity, and the water level is quickly restored. This calculation is only run for 24 hours to show the effectiveness of mitigation. Therefore, it is concluded that for all slow leak scenarios, the fuel never becomes uncovered since the makeup capacity is twice the leak rate. The leak rate is only a function of the water level (hydrostatic head) and is independent of the SFP configuration as long as the water level remains above the top of the racks.



**Figure 50 Water level for mitigated low-density OCP1 (small leak) scenario**



**Figure 51 Flow rates for mitigated low-density OCP1 (small leak) scenario**

#### Unsuccessful Deployment of Mitigation for OCP4 and OCP5 Scenarios

For OCP4, the decay heat is between 37 percent to 48 percent lower than for OCP3. None of the scenarios in OCP4 or OCP5 leads to a release from the fuel.<sup>26</sup> Figure 52 through Figure 55 illustrate the thermal-hydraulic response of the high-density pool to a small leak and a moderate leak. It takes less than 6 hours to clear the rack baseplate and initiate airflow for the moderate leak, while for the small leak case, the rack baseplate does not clear until about 39 hours. In both cases, there is a heatup of the fuel as the water level is reduced below approximately half the height of the fuel. For the small leak case, it takes longer and the heatup is slower since there is some steam cooling of the fuel.

The heatup rates for the low-density cases are somewhat similar to the high-density cases (see Figure 56 or Figure 57). The maximum clad temperature and the initial heatup rate in Ring 1 is actually higher for the low-density cases because of reduced heat transfer from Ring 1 to Ring 2.<sup>27</sup> Even though the total decay heat in the pool for low-density case is only 77 percent of the high-density case, the decay heat in Ring 1 is identical in both cases.

<sup>26</sup> The start of the release of radionuclides from the fuel is modeled based on a temperature of 900 degrees C (1,173 K). At this temperature, the cladding is assumed to fail and the gap inventory from the fuel is released. Further release from the fuel is based on the CORSOR-Booth model and is a function of fuel temperature (Gauntt, 2010).

<sup>27</sup> The reduced mass in Ring 2 (only racks) initially limits heat transfer from Ring 1 until a sustained natural circulation is established.

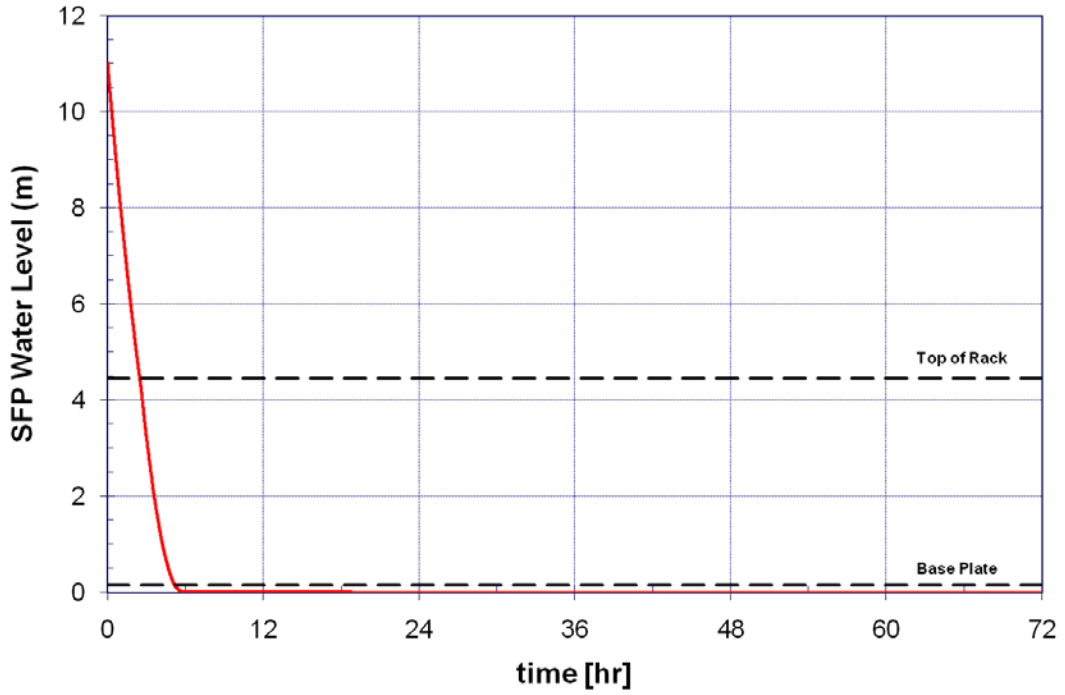


Figure 52 Water level for unmitigated high-density moderate leak (OCP4)

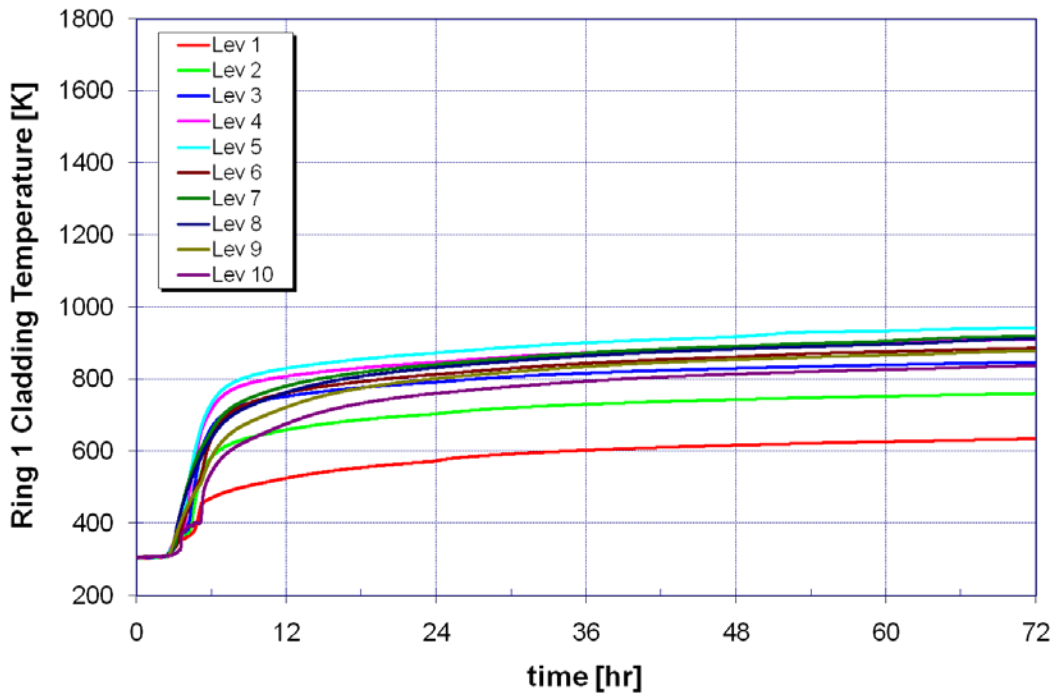


Figure 53 Ring 1 temperature for unmitigated high-density moderate leak (OCP4)

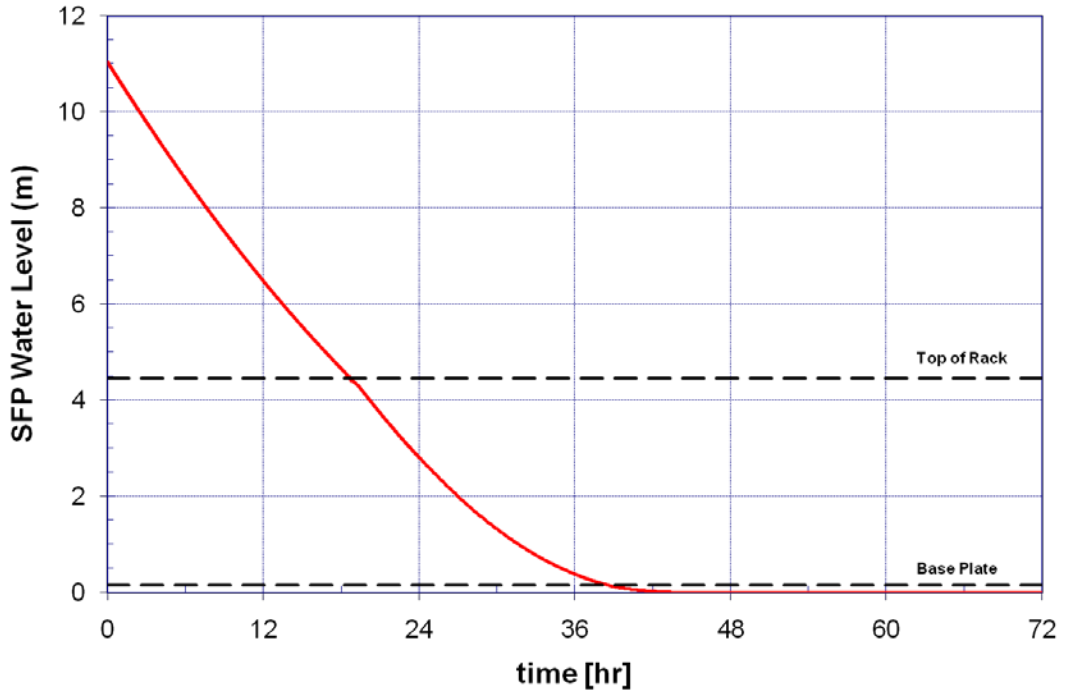


Figure 54 Water level for unmitigated high-density small leak (OCP4)

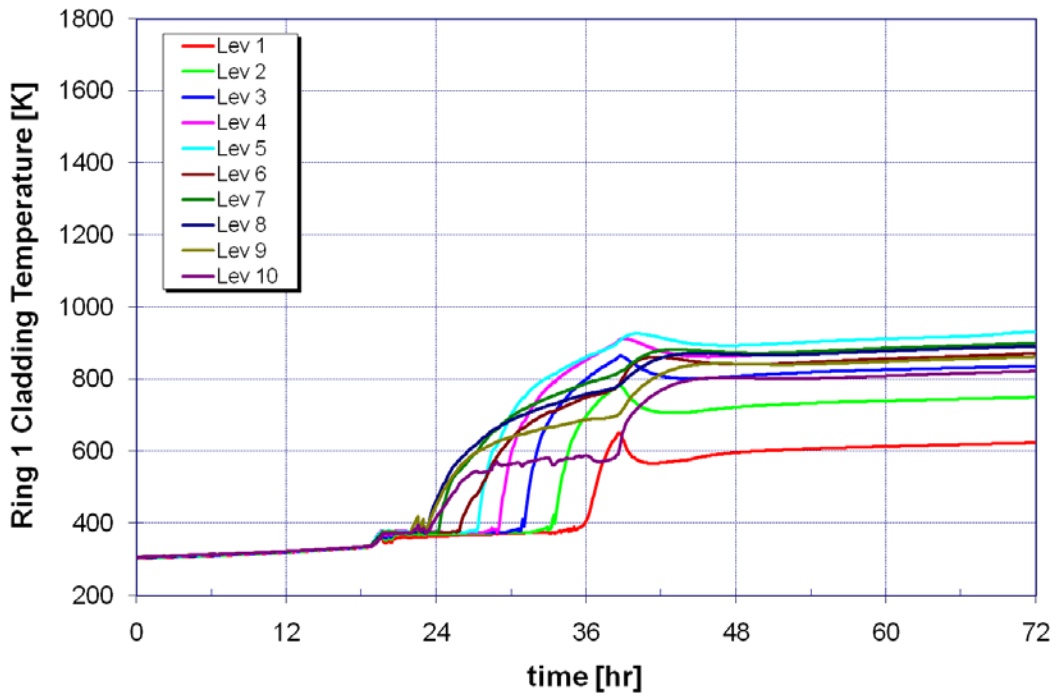


Figure 55 Ring 1 temperature for unmitigated high-density small leak (OCP4)

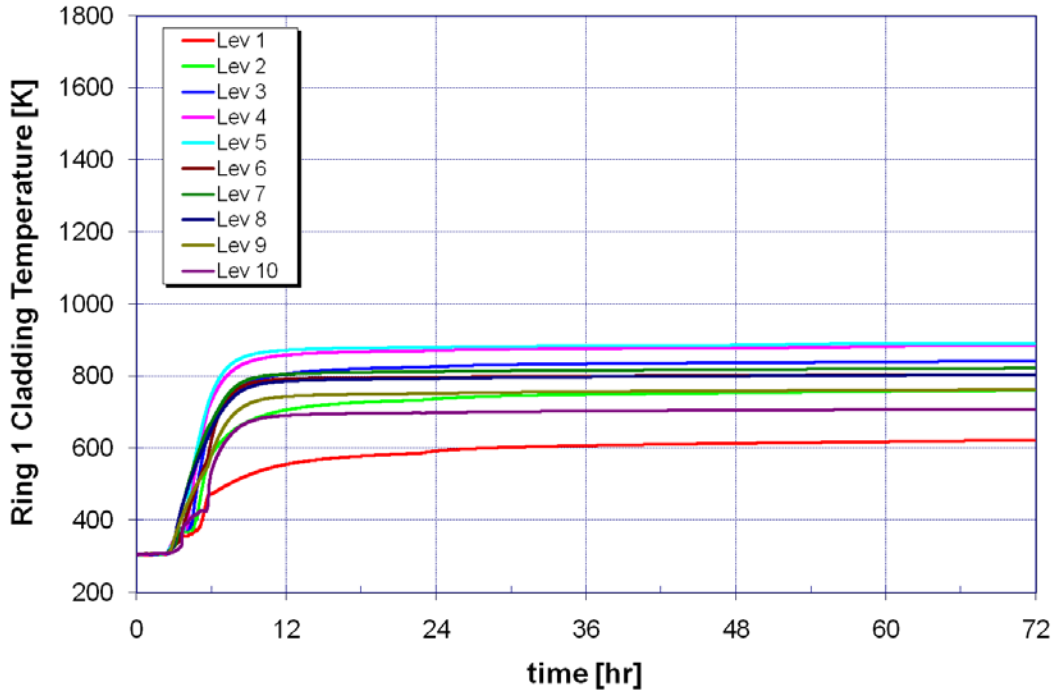


Figure 56 Ring 1 temperature for unmitigated low-density moderate leak (OCP4)

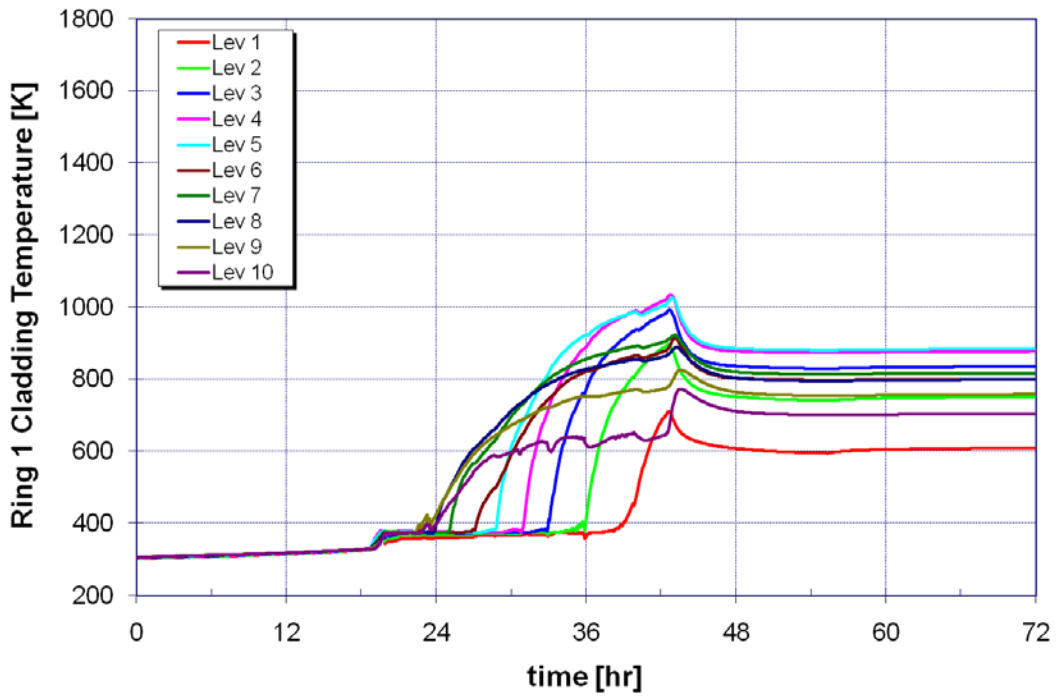


Figure 57 Ring 1 temperature for unmitigated low-density small leak (OCP4)

## Mitigated Moderate Leak Scenarios in OCP2, OCP3, OCP4, and OCP5

Mitigation for moderate leak cases involves actuation of the sprays for the postoutage scenarios (OCP3, OCP4, and OCP5) and direct injection in OCP1 and OCP2. The moderate leak is modeled in MELCOR with a 11.4-cm- (4.5-in.-) diameter hole at the bottom of the pool based on the structural analysis and damage to the pool (effective size of cracks in the liner and the concrete). Section 6.1.3 of this report discussed the MELCOR modeling of the sprays and presented two modeling options (i.e., simple flow regime model on or off). Only high-density OCP3 results<sup>28</sup> are presented since the unmitigated scenarios in later phases do not lead to release, and the moderate leak size is large enough to avoid the baseplate blockage resulting from quasi-steady water level at the bottom of the pool in response to the 200-gpm (0.013-m<sup>3</sup>/s) spray water. The results of the OCP2 calculation showed no release from the fuel resulting from various heat transfer mechanisms (see also discussion for OCP1 in Section 6.3.2 of this report).

Figure 58 shows the water level for the moderate leak, high-density OCP3 scenario. Because of the spray activation at 3 hours (see Figure 59), the bottom of the racks clears for natural circulation airflow more than 1 hour later compared to an unmitigated case (see Figure 52). Finally, the spray flow rate and the leak rate are equilibrated by about 8 hours as required by the hydrostatic head at the bottom of the pool. The actual spray water reaching the bottom of the pool is somewhat less than 200 gpm (0.013 m<sup>3</sup>/s) in Figure 59 because of heat transfer from spray droplets to the atmosphere and fuel rods.<sup>29</sup> Figure 60 shows the response of the clad in Ring 1 for the case in which the simple flow regime model is active. As expected, the top cells experience more cooling as there is more water coverage. The temperatures reach a quasi-steady state by about 10 hours<sup>30</sup> and the maximum clad temperature is about 850 K. Figure 61 shows the clad temperatures for the case in which the simple flow regime model is disabled. In this mode, the main cooling mechanism is by convection from the fuel rods to the atmosphere, and none of the axial segments experience quenching. The maximum clad temperature is about 840 K, which is comparable to the previous case. Thus, even though the details of heat transfer and fuel heatup differ, the maximum clad temperatures are almost the same and well below the gap release criterion. This is partially because of the importance of the heat removal by natural circulation of air through the racks. If there was no natural circulation of air through the racks, the cooling of the fuel by the spray flow (i.e., modeled with the simple flow regime map) would be the only effective cooling mechanism, and therefore would be very important to the coolability of the fuel.

To further test the impact of the modeling assumptions, two additional calculations were performed by assuming an additional 3-hour delay in the actuation of the spray as shown in Figure 62.<sup>31</sup> Both Figure 63 and Figure 64 show that (for OCP3), following the initial heatup of the fuel and reaching a maximum clad temperature (just below 900 K) at about 6 hours, the spray flow rate is sufficient to cool the fuel and avoid release.

---

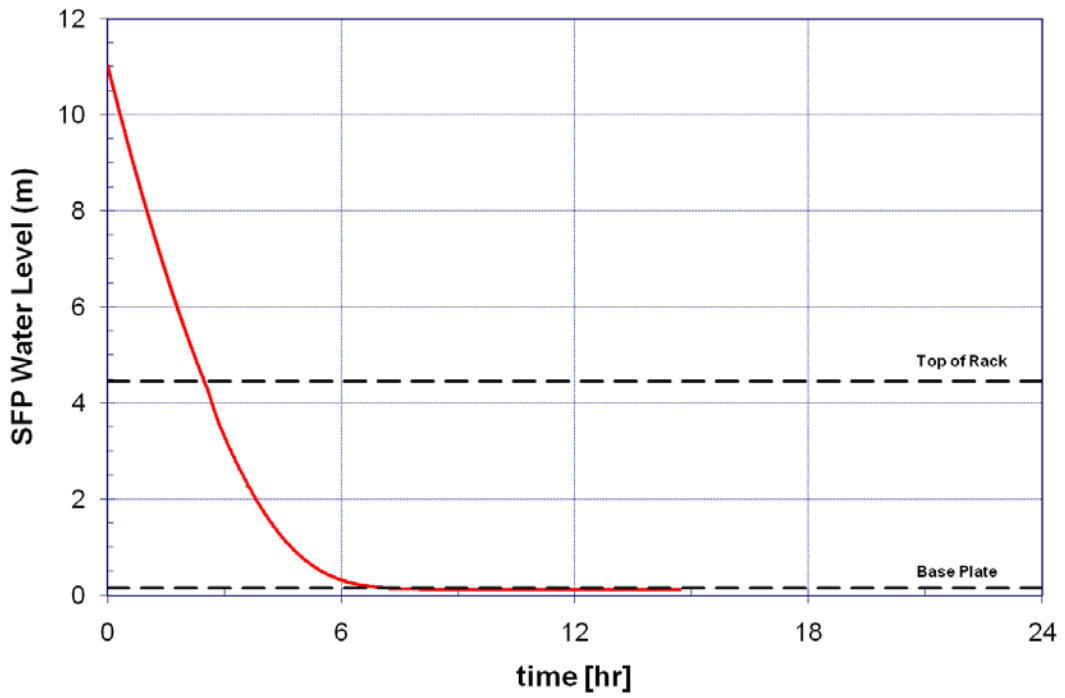
<sup>28</sup> The low-density case is similar to the high-density case, and there is no release.

<sup>29</sup> It would take about 15 gpm of water to remove the entire decay heat in the pool. However, some of the decay heat is being removed by natural circulation through the assemblies and leaking out of the reactor building.

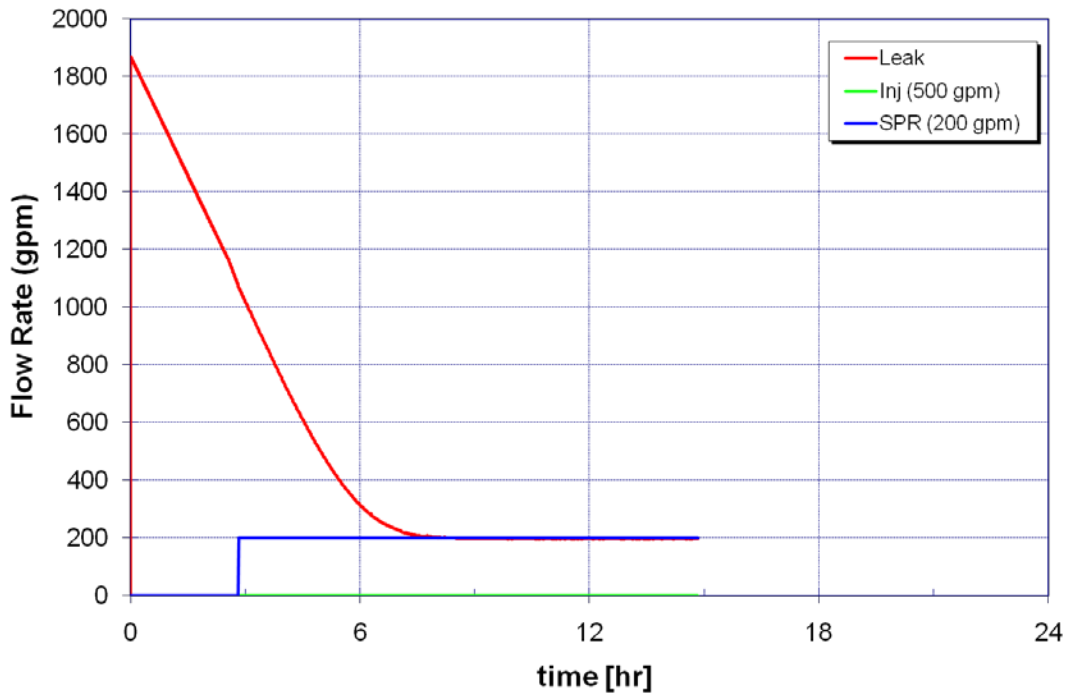
<sup>30</sup> The calculation fails shortly after 10 hours from numerical problems.

<sup>31</sup> These cases were actually run based on an earlier logic for spray actuation that assumed a 3-hour additional delay at the end of deployment.





**Figure 58 Water level for mitigated high-density moderate leak (OCP3)**



**Figure 59 Water flow rates for mitigated high-density moderate leak (OCP3)**

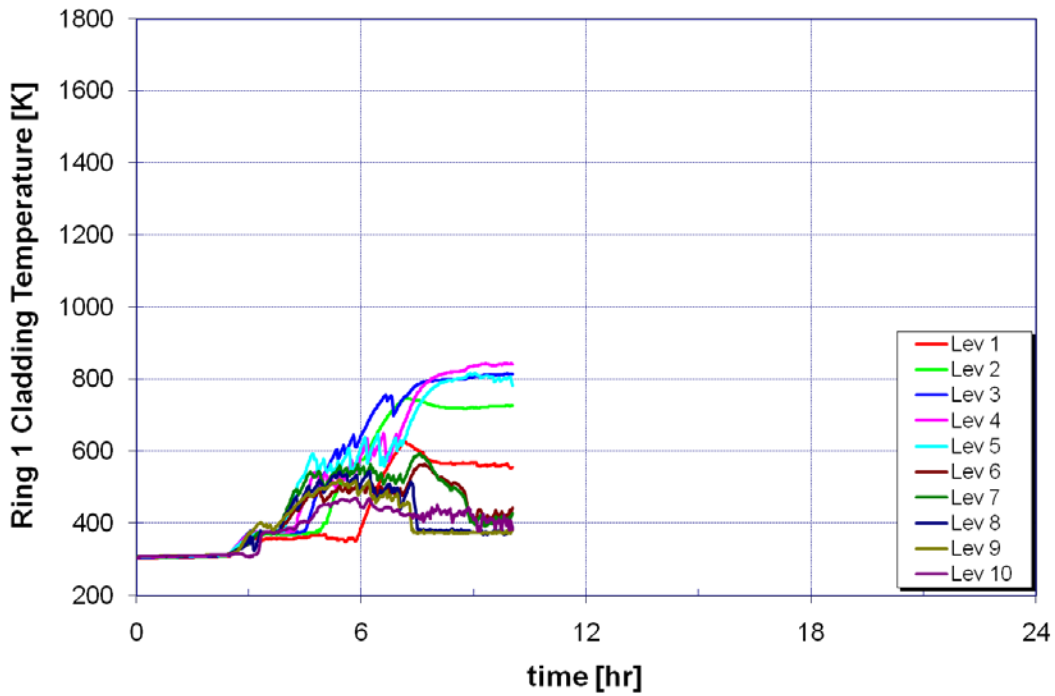


Figure 60 Ring 1 clad temperatures for mitigated (simple flow regime active) high-density moderate leak (OCP3)

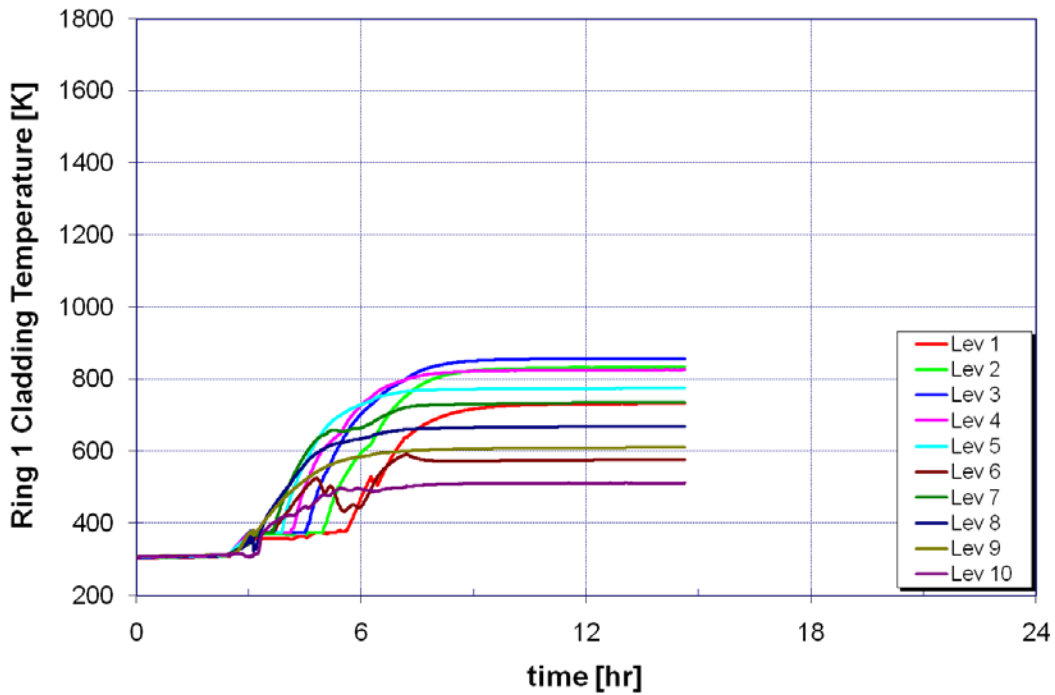


Figure 61 Ring 1 clad temperatures for mitigated (simple flow regime inactive) high-density moderate leak (OCP3)

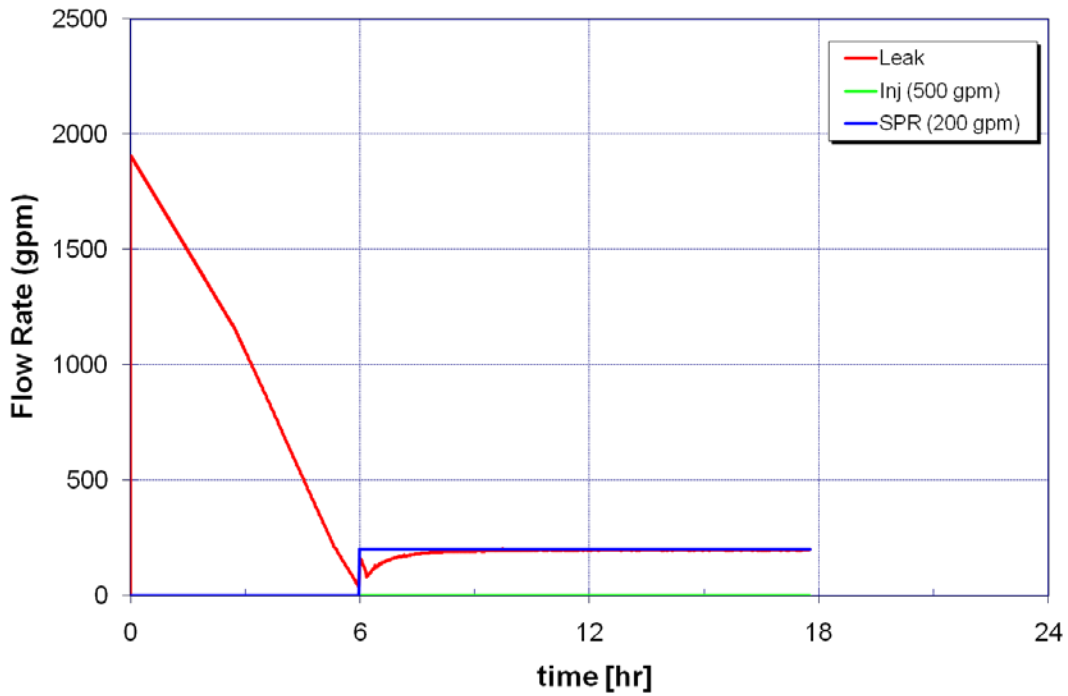


Figure 62 Flow rates for mitigated high-density moderate leak (OCP3) with late actuation of sprays

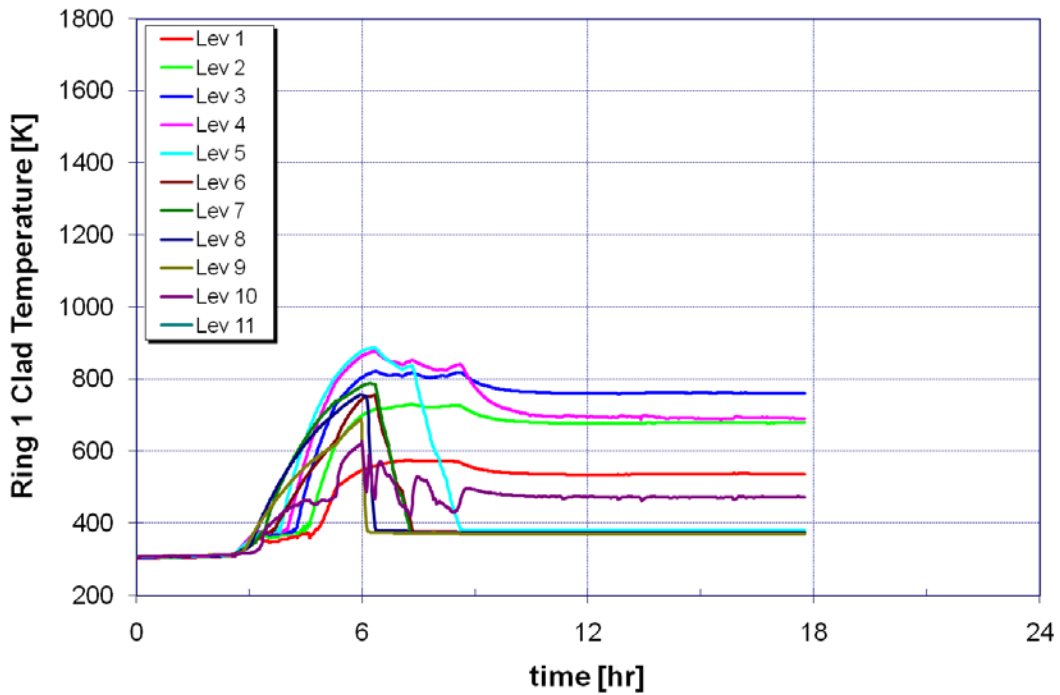
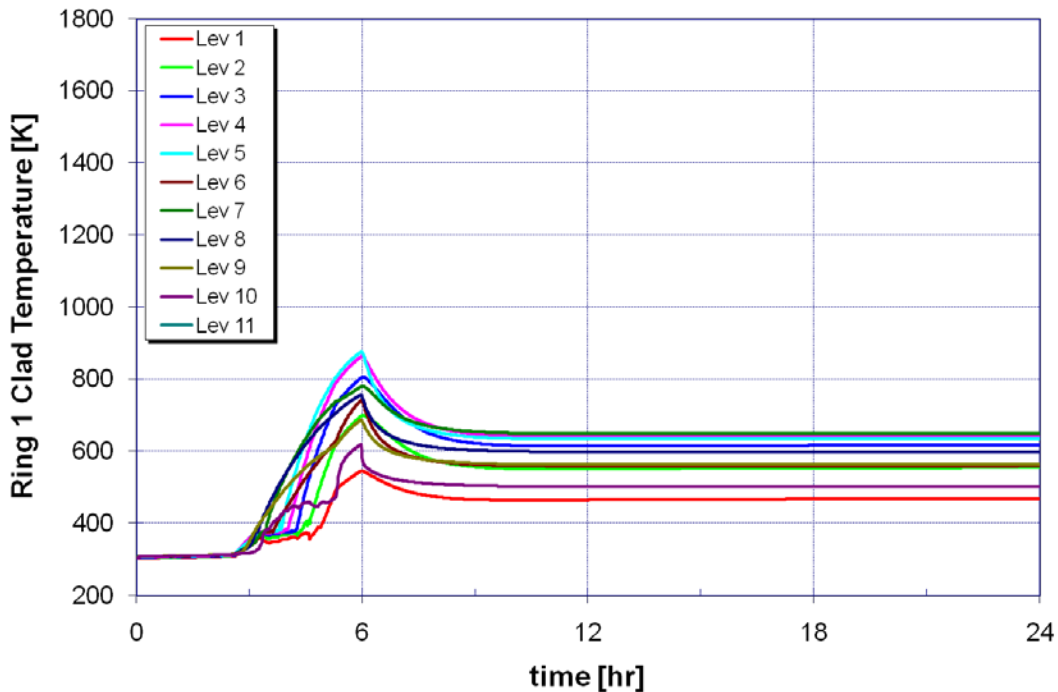


Figure 63 Ring 1 clad temperatures for mitigated (simple flow regime active) high-density moderate leak (OCP3) with late actuation of sprays



**Figure 64 Ring 1 clad temperatures for mitigated (simple flow regime inactive) high-density moderate leak (OCP3) with late actuation of sprays**

### 6.3.2 Sequences That Do Lead to a Release

All the sequences in OCP1, OCP2, and OCP3 lead to release without successful deployment of mitigation. This section will only discuss representative scenarios to illustrate the accident progression phenomenology. One of the phenomena that has a significant impact on the overall release is the failure of the reactor building as a result of failure of the blowout panels or the roof. Failure of the reactor building introduces additional air that results in further oxidation of the hot fuel leading to enhanced release and fuel failure. The refueling room with the SFP at the top of the reactor building is modeled as a single volume (Figure 42), and hydrogen released from the SFP is assumed to mix with the entire volume. It is assumed that the hydrogen will combust at a 10-percent concentration if there is adequate oxygen (oxygen concentration is greater than or equal to 5 percent) and no steam inerting (steam concentration is less than or equal to 55 percent). The analysis considered the sensitivity of the ignition assumptions and potential for reactor building refueling bay failure on a case-by-case basis (see Section 9.1 of this report).

#### Unsuccessful Deployment of Mitigation for Moderate Leak (OCP1) Scenario

The water level for the high-density scenario (Figure 65) shows that it takes about 8.5 hours to clear the rack baseplate and establish natural circulation in the pool. The timing is longer compared to postoutage scenarios (see Figure 52) because of the additional water in the reactor well connected to the SFP. The reactor power (Figure 66) is assumed to go to zero as the water level reaches the SFP gate and the pool is disconnected from the reactor well.

As the water level decreases, the clad temperatures (Figure 67) start to increase initially as a result of decay heat and then by clad oxidation as air is circulated through the assemblies. The

heatup of the cladding in Ring 1 results in a zirconium fire that starts near the top of the full rod region (see Figure 41) and propagates downward. The heatup in Ring 1 (fuel, cladding, canister, and racks) propagates to Ring 2 assemblies (Figure 68) and leads to the failure of the racks in Rings 1 and 2. The failure of racks at about 12 hours results in formation of a debris bed in the bypass and relocation to the baseplate, but the channel boxes are still intact at this time. Between 13.6 and 14.2 hours, the channel boxes in Rings 1 and 2 fail, which allows additional cooling of the debris through flow diversion from the bypass region. As a result, the oxidation power is reduced and the heat transfer from the hot inner assemblies is propagated outward and starts to gradually heat up the SFP wall liner.<sup>32</sup> Natural circulation and radial heat transfer throughout the SFP keeps the temperatures relatively low following the initial heat up in Rings 1 and 2. However, the fuel continues to slowly heat until a second zirconium fire initiates at the top of the fuel in Ring 4 at about 42 hours in the upper levels which then propagates downward. The second heatup is more intense and involves the other rings as indicated by both the oxidation power (Figure 66) and the clad temperatures in the outer rings (Figure 68).

OCP1 had a relatively rapid draindown in which an air natural circulation flow developed through the racks before significant oxidation of the fuel. As a result of a relatively short duration of the steam oxidation phase, there was relatively little hydrogen generation.<sup>33</sup> The peak concentration in the refueling floor was only 5 percent, which is well below the minimum threshold for combustion and below a quantity that would lead to a significant pressurization of the reactor building. Consequently, there was no potential for a burn inside the refueling bay, which remained intact.

The fission product releases began at about 12 hours. Because the reactor building remained intact, all releases to the environment are limited by the nominal leakage (see Figure 42). The reactor building DF is shown in Figure 71.<sup>34</sup> Aerosols also begin to deposit inside the building and the DF for cesium and iodine aerosols remains between 3 to 4 for much of the accident. The DF is defined as the ratio of fractional release from the fuel to the fractional release to the environment. As discussed before, MELCOR keeps track of the fuel releases from individual rings. The fuel releases are divided by the overall DF to arrive at the environmental release for each ring. MELCOR mechanistically models all deposition mechanisms; however, because of the mixing within the reactor building, only an overall DF can be defined for all rings.

Figure 72 depicts the cesium environmental release fraction for individual rings. The release starts at about 9 hours from Ring 1 followed by the release from Ring 2 at 12 hours. The release profiles are consistent with the heatup in Figure 68. The later releases result from the second heatup and involve all of the outer rings (Ring 3 is empty for OCP1). The total release fraction is the input to the MACCS2 code for consequence analysis and is defined by Equation

---

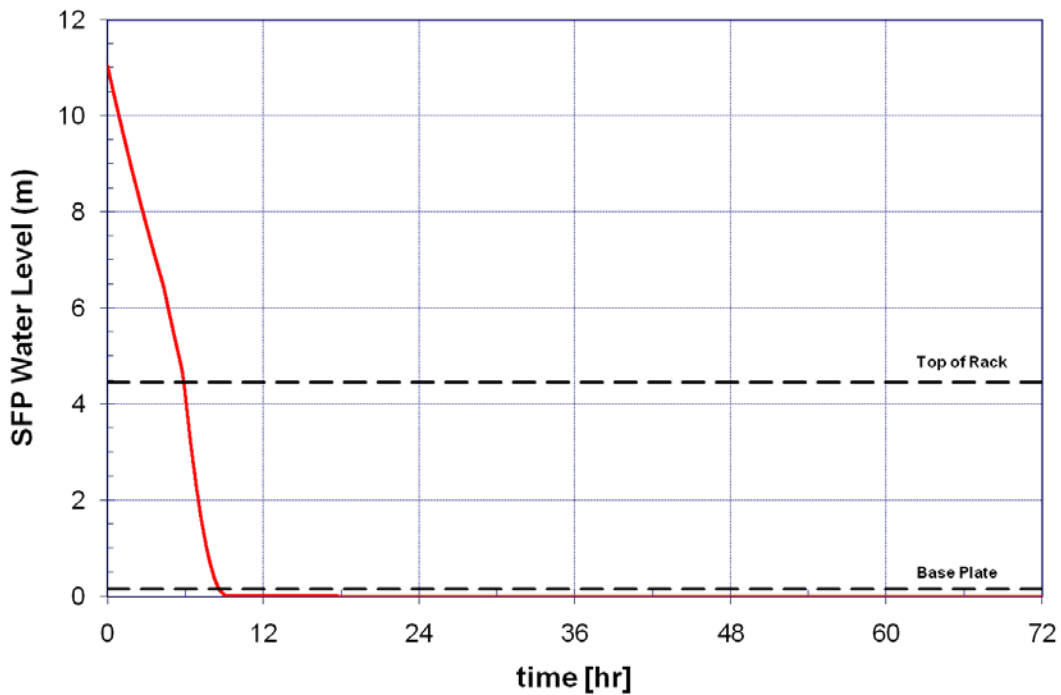
<sup>32</sup> The initial heatup of the liner is caused by heat transfer from the water. There is an initial cooldown as cooler air circulates before the heatup from the fuel caused the temperature to increase.

<sup>33</sup> Hydrogen generation only occurs by oxidation of the SFP Zircaloy and steel with steam. Hydrogen is disassociated from the steam and released into the building, which can lead to combustion. If oxygen is present, then only air oxidation occurs and there is no hydrogen generation. In a larger leak, the water level drops below the bottom of the racks and allows natural circulation of air, which will preclude steam oxidation.

<sup>34</sup> The integral DF is the ratio of the fission products released from the fuel to the amount that reaches the environment. Upon the start of fission product releases, the quantity is infinite until the release to the environment begins. Consequently, the initial peak is an artifact of the definition, whereas the long-term value is best characteristic of the reactor building performance.

11.<sup>35</sup> The DF is a dynamic quantity as the outer rings start to release (see the fluctuations in Figure 71); therefore, care is taken to allow the earlier releases from inner rings preserve their release history so that the total release fraction does not decrease at any time as the release progresses.

Figure 73 illustrates the results of the low-density case. Comparing the heatup with the high-density case (see Figure 67), the Ring 1 low-density case clearly heats up more rapidly initially since there are a lot of empty cells surrounding it (with the exception of the rack component) and heat is not very efficiently transferred radially, which results in slower heatup of Ring 5, as shown in Figure 74. Even though the racks fail in this low-density case, the canisters remain intact and the zirconium fire moves down initially and then upwards, as shown in Figure 73. The cesium environmental release fraction for Ring 1 shown in Figure 75 is comparable to the high-density case (Figure 72), but since no release occurs from the older assemblies, the total release fraction for the low-density case is lower.



**Figure 65 Water level for unmitigated high-density moderate leak (OCP1)**

<sup>35</sup> This activity-weighted release is a function of the inventories in each ring. Therefore, there is more contribution from the outer rings that have higher inventories even though the release from these rings is smaller compared to Ring 1.

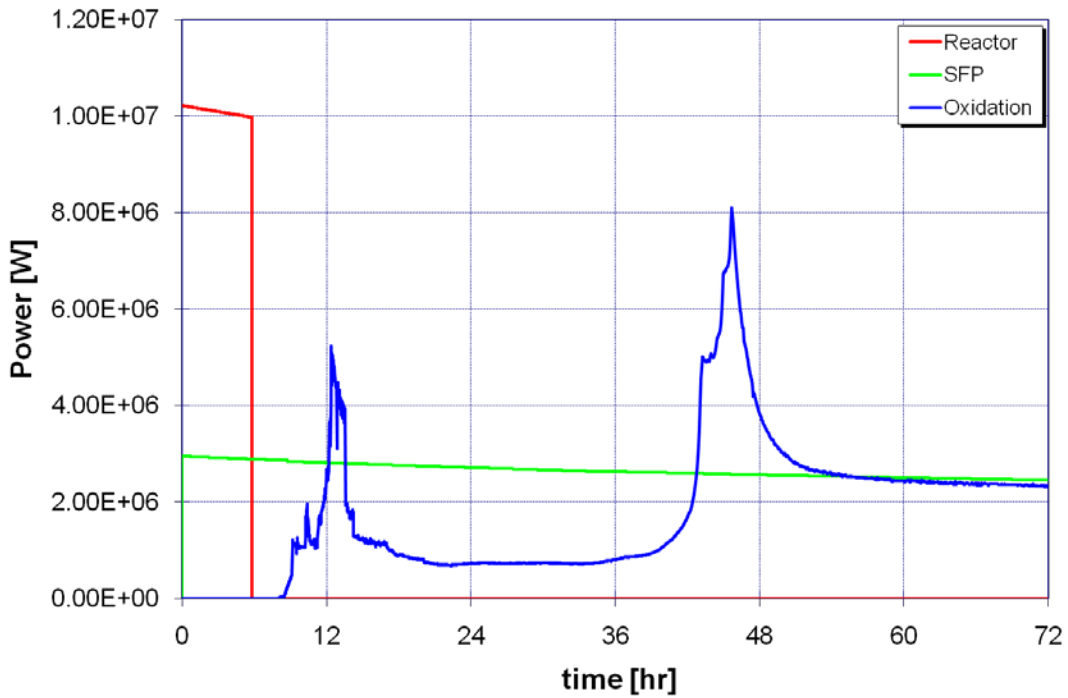


Figure 66 SFP power for unmitigated high-density moderate leak (OCP1)

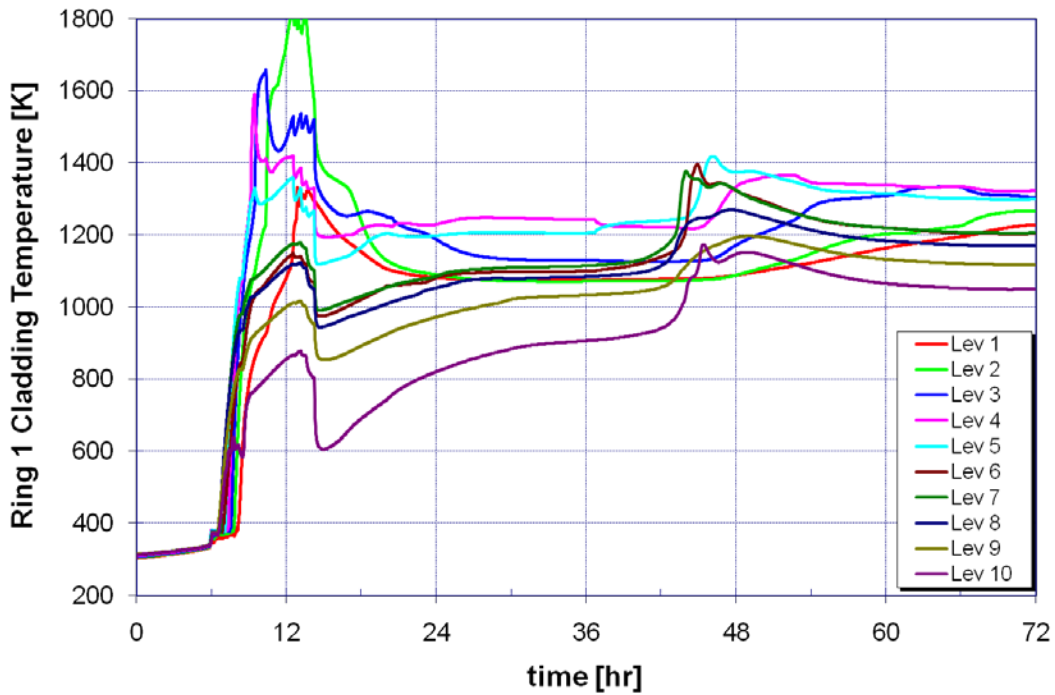


Figure 67 Ring 1 clad temperature for unmitigated high-density moderate leak (OCP1)

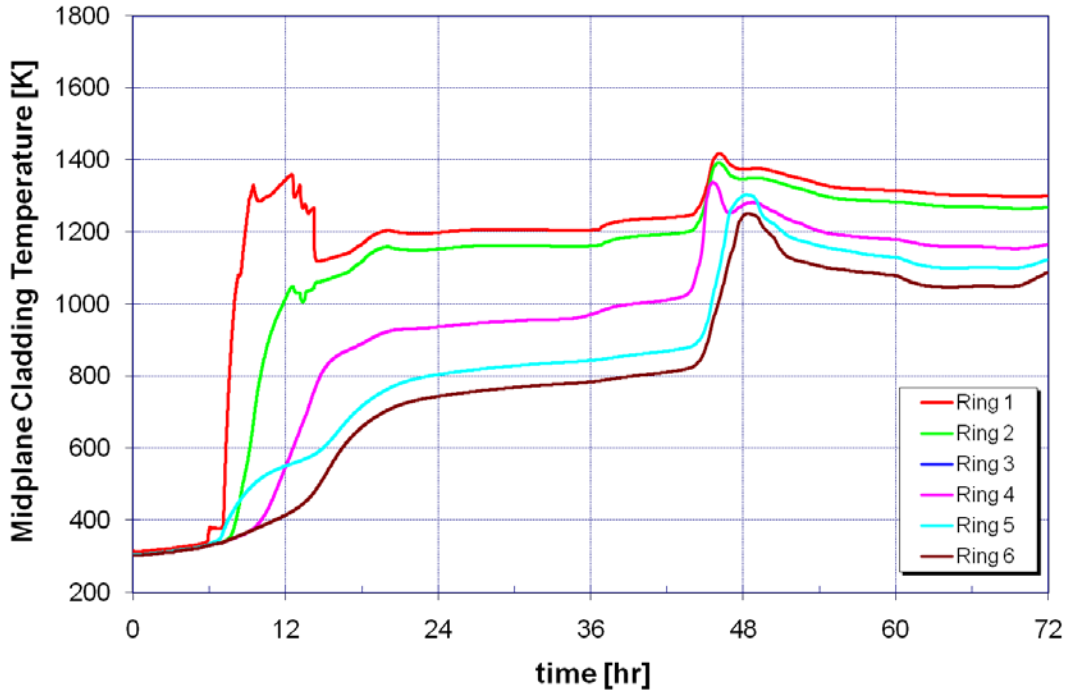


Figure 68 Midplane clad temperature for unmitigated high-density moderate leak (OCP1)

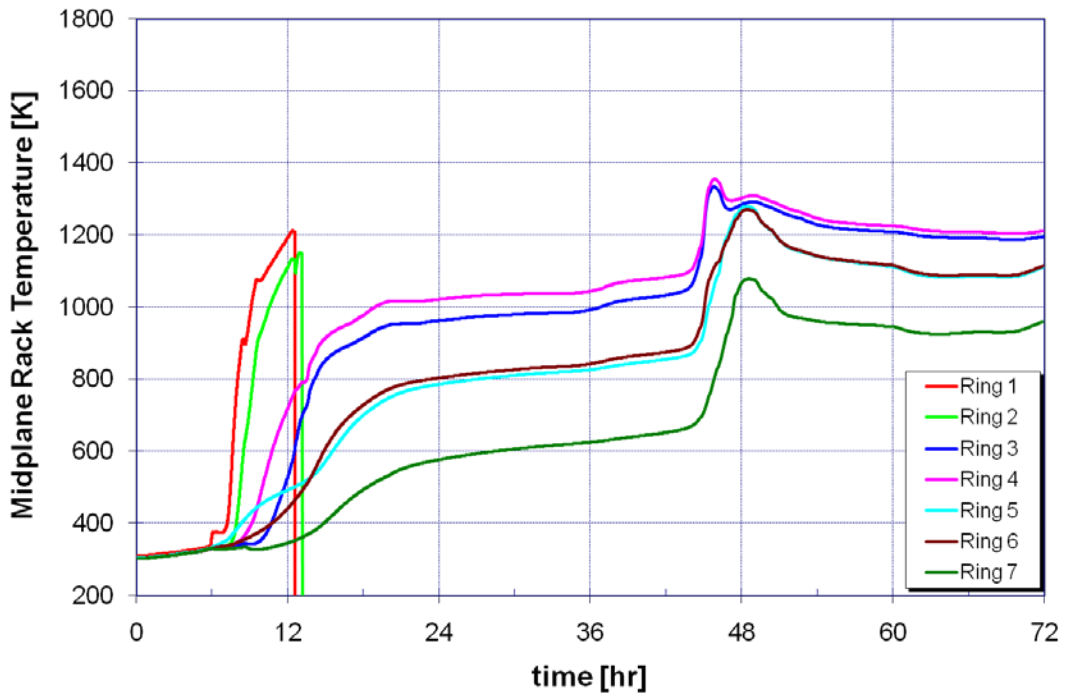


Figure 69 Midplane rack temperature for unmitigated high-density moderate leak (OCP1)



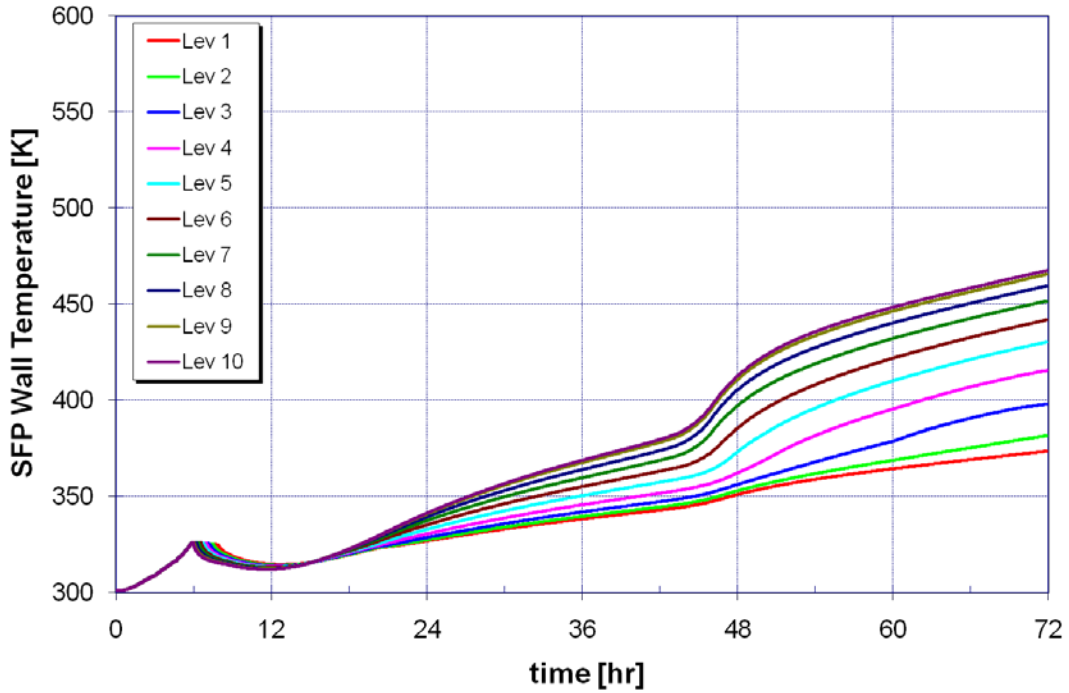


Figure 70 SFP wall liner temperature for unmitigated high-density moderate leak (OCP1)

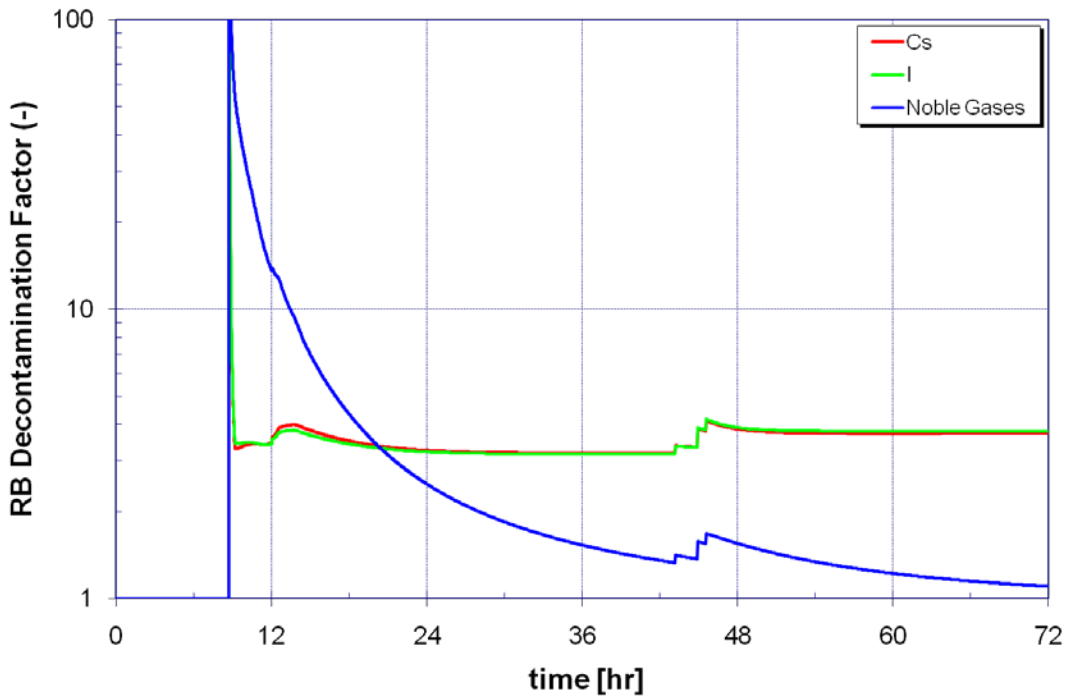


Figure 71 Reactor building DF for unmitigated high-density moderate leak (OCP1)

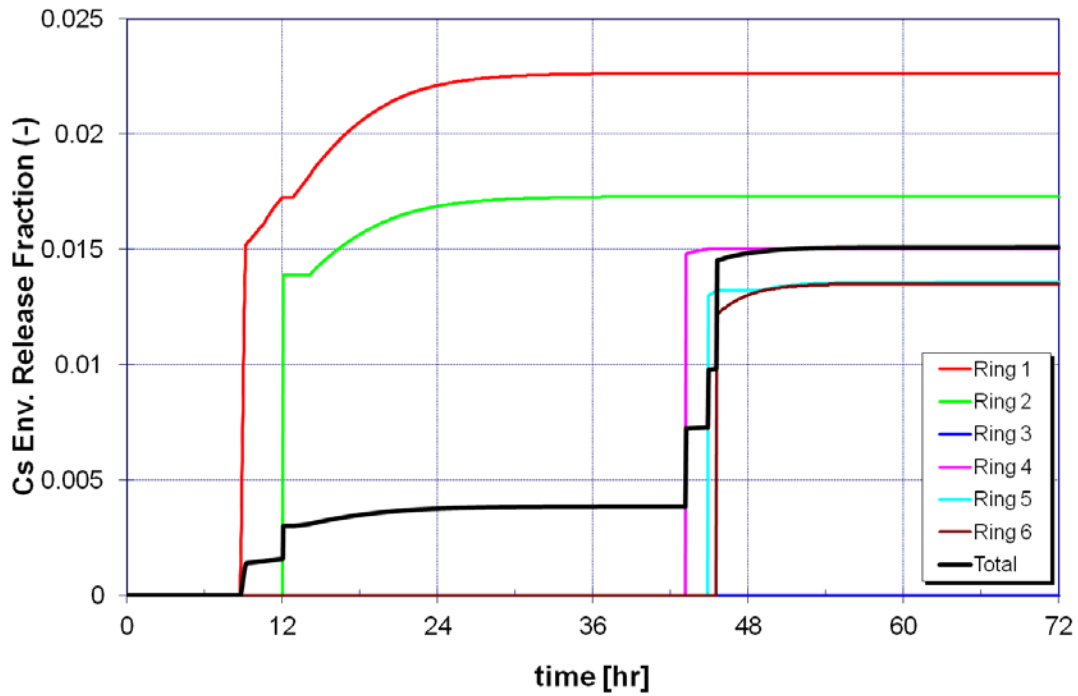


Figure 72 Cesium environmental release fraction for unmitigated high-density moderate leak (OCP1)

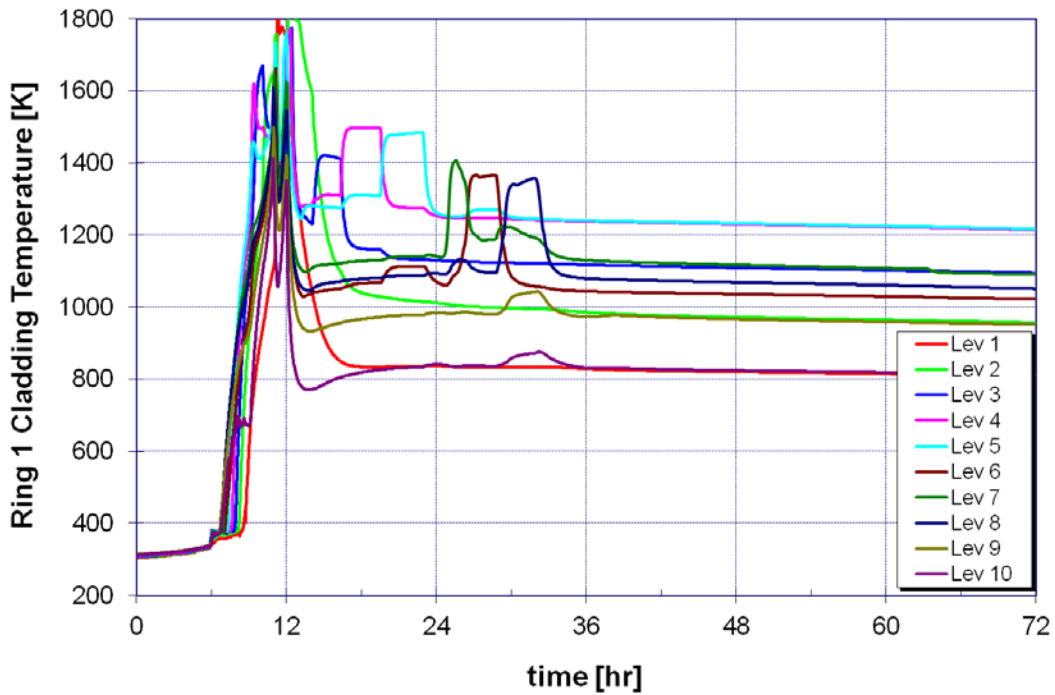


Figure 73 Ring 1 clad temperature for unmitigated low-density moderate leak (OCP1)

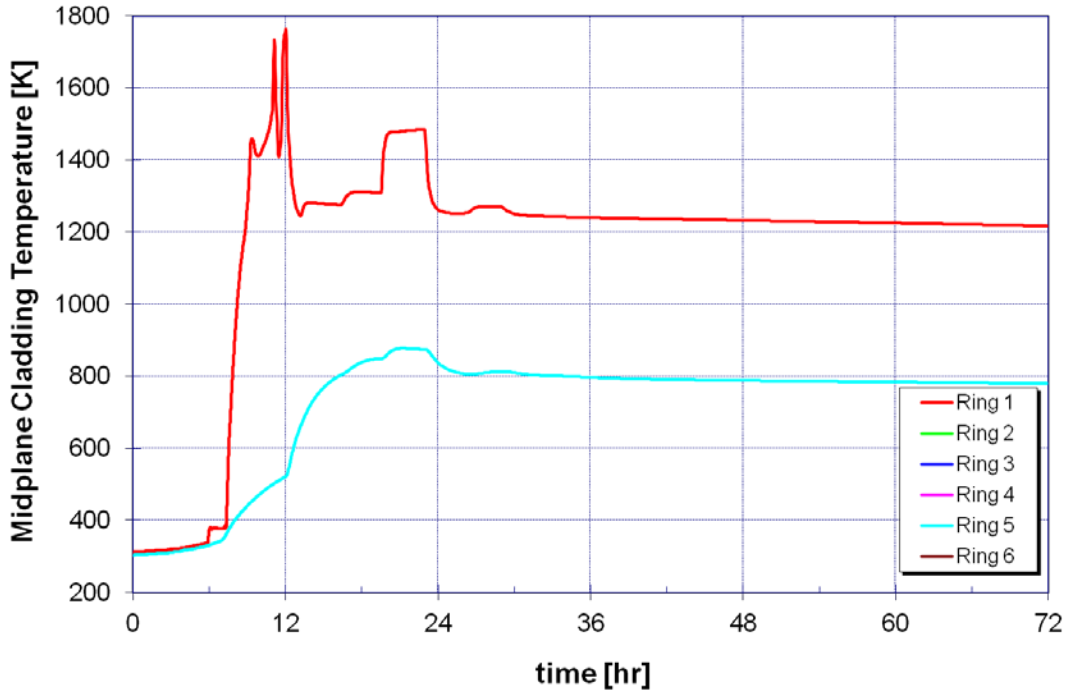


Figure 74 Midplane clad temperature for unmitigated low-density moderate leak (OCP1)

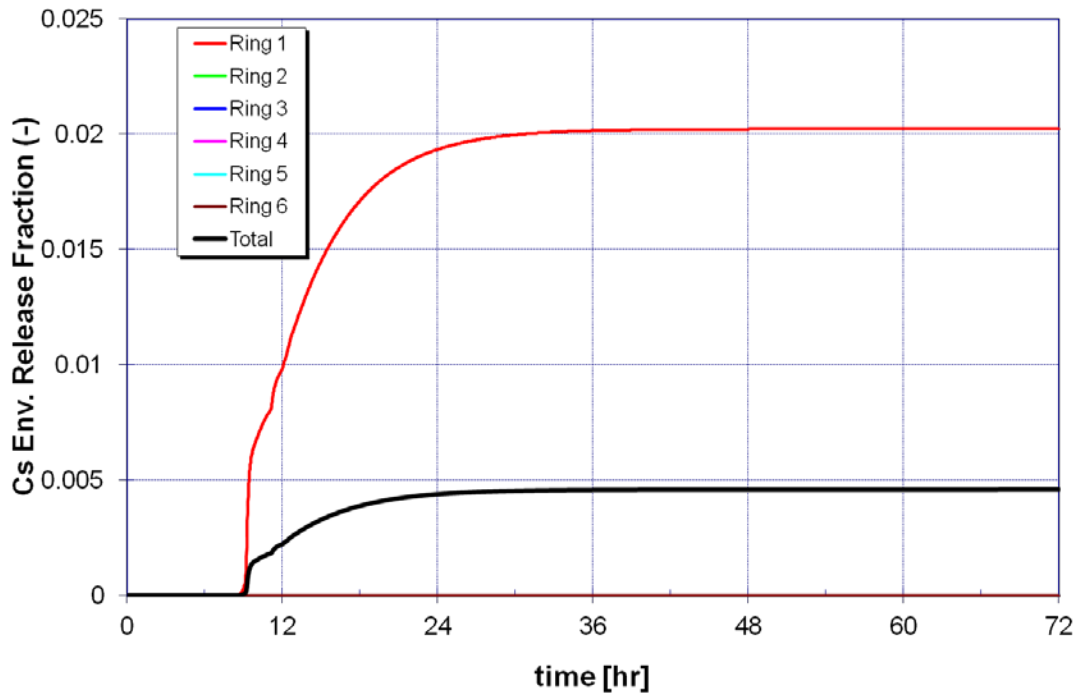


Figure 75 Cesium environmental release fraction for unmitigated low-density moderate leak (OCP1)

## Mitigated Moderate Leak (OCP1) Scenario

Figure 76 illustrates the response of the pool to the mitigated scenario. The connectivity between the reactor and the SFP, as well as the additional volume of water, results in a relatively slow draindown. Thus, at the end of the mitigation deployment, the water level in the pool is more than 0.9 m above the top of the rack.<sup>36</sup> Therefore, instead of spray, mitigation is by direct injection into the pool. After about 12 hours, the water level remains relatively constant and the leak rate is balanced by the injection into the pool. The lower portions of the fuel remain cool and covered with water. Although heatup of the fuel occurs (see Figure 77), there is no indication of a zirconium fire and propagation through the pool. The peak fuel temperature reached 1200 K at 16 hours and remained near that value through 72 hours. A combination of radial heat transfer within the assembly; radial heat transfer from the recently discharged, high-temperature fuel to adjacent fuel assemblies; and steam cooling from boiling in the bottom of the assemblies between cells keep the fuel temperature near 1200 K. Only Ring 1 had cladding failure and subsequent releases of the gap inventory, as shown in Figure 78. All other fuel was below the threshold for cladding failure and fission product releases.

Figure 79 shows the clad temperature in Ring 1 for the low-density case. The heatup rate for the low-density case is more extreme than the high-density case, as was observed for the mitigated cases. Unlike the high-density case, the low-density case did not have low decay heat fuel assemblies adjacent to the recently discharged assemblies. Since an air natural circulation pattern through the racks was not established, the empty cells isolated the high decay heat assemblies and contributed to the higher heatup. The fuel in Ring 1 went through an oxidation transient, which led to peak fuel temperatures of 1800 K. However, once the steam in the assembly was consumed, the fuel temperatures dropped to 1200 K. The subsequent behavior was driven mainly by the decay heat, which was very similar to the high-density case. Higher fuel temperatures during the initial oxidation transient led to slightly more release in the low-density case.

---

<sup>36</sup> The level was close to 0.9 m above the top of the fuel of the fuel at the timing of the deployment of the sprays (i.e., 9.5 hours). If the spray system was used, cooling would be provided to the uncovered portion of the fuel. The accident could have benefitted from natural circulation of air through the racks once the water level dropped below the rack baseplate and spray cooling from the top.

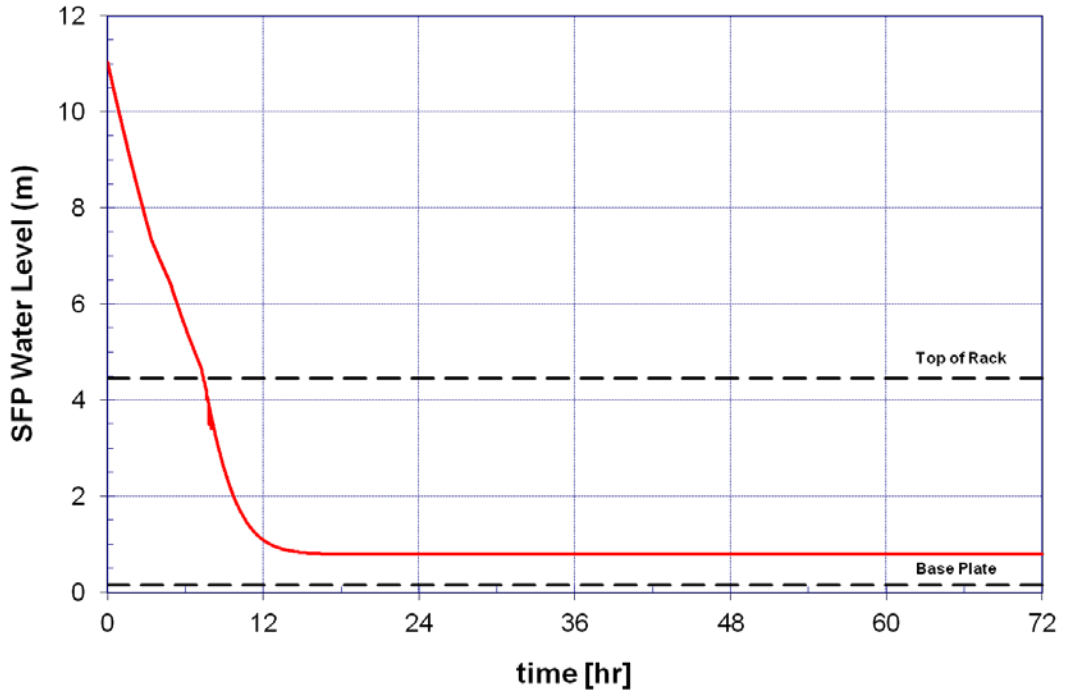


Figure 76 Water level for mitigated high-density moderate leak (OCP1)

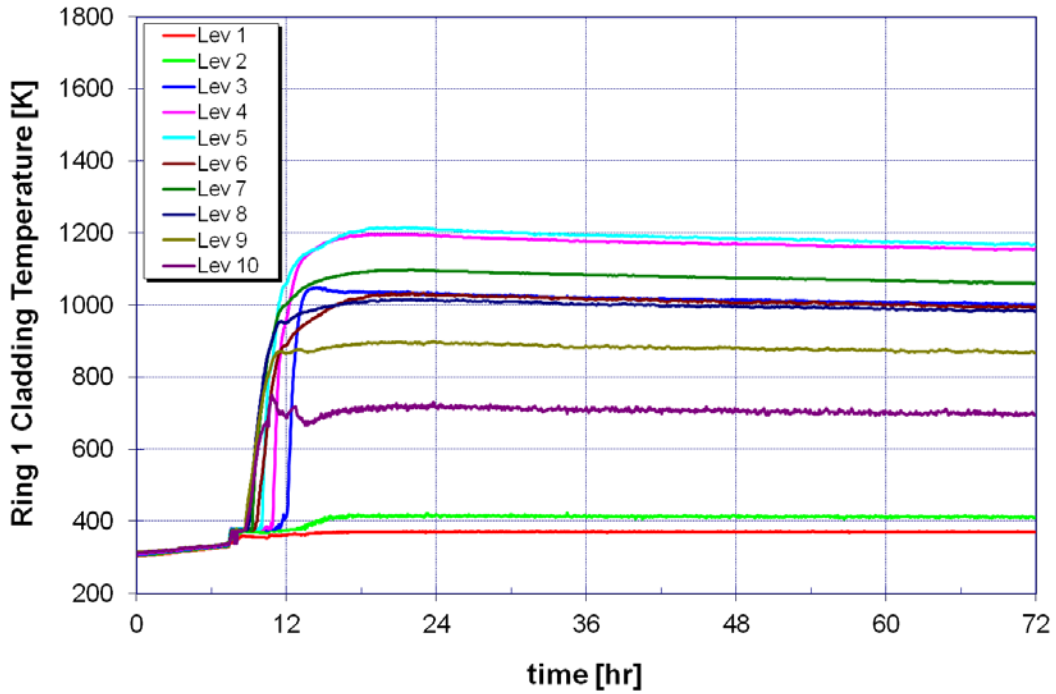


Figure 77 Ring 1 clad temperature for mitigated high density moderate leak (OCP1)

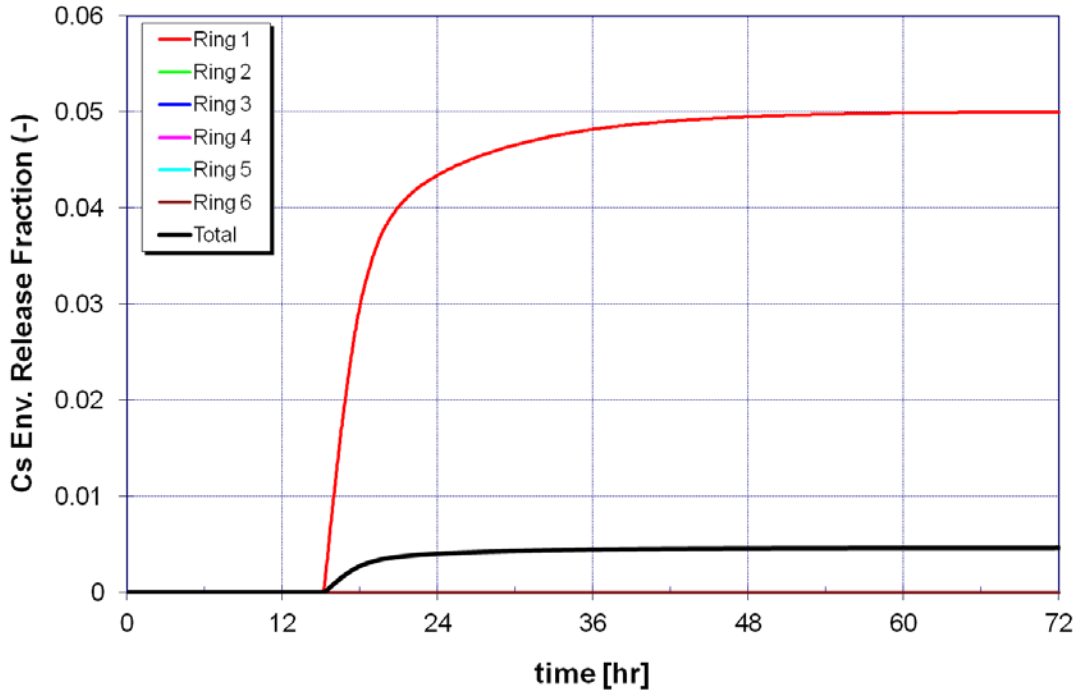


Figure 78 Cesium environmental release fraction for mitigated high density moderate leak (OCP1)

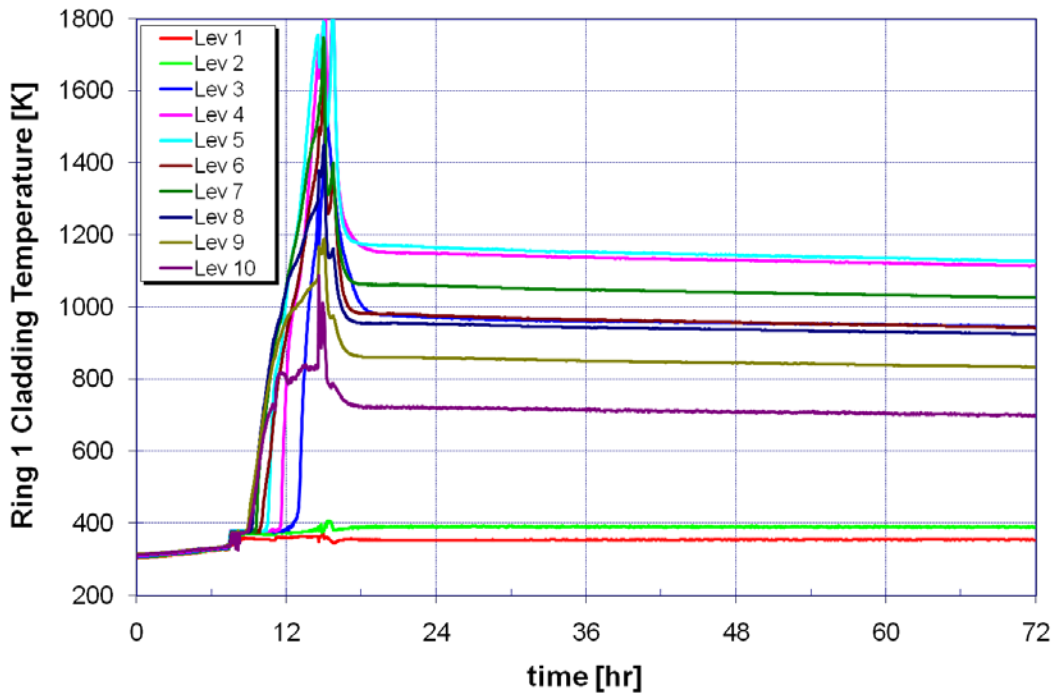
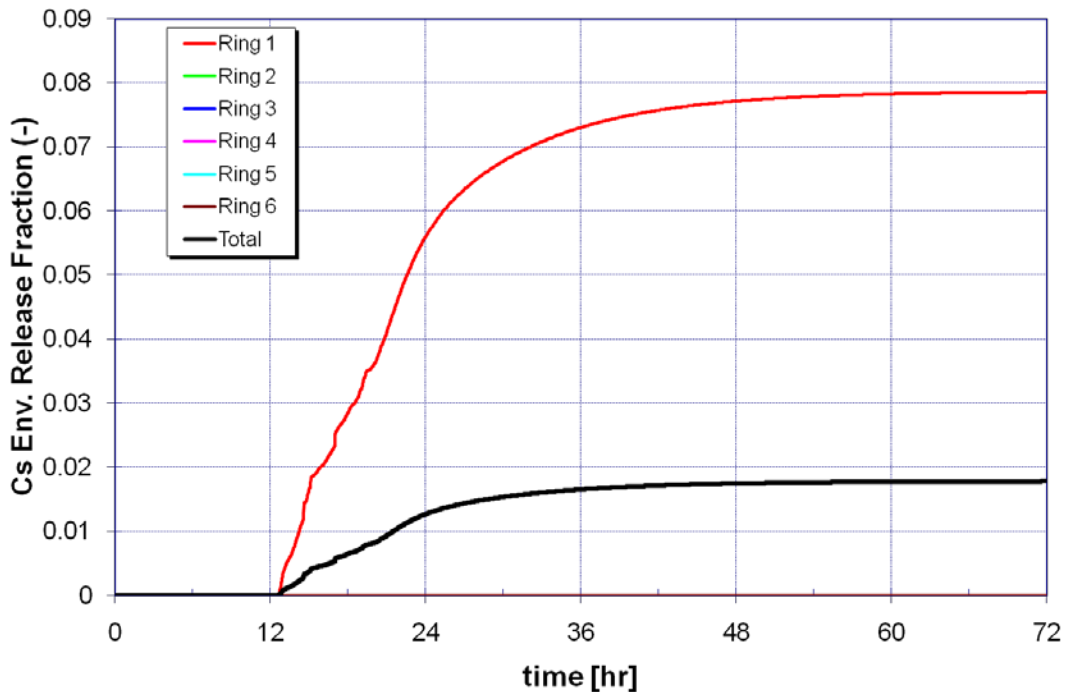


Figure 79 Ring 1 clad temperature for mitigated low density moderate leak (OCP1)



**Figure 80 Cesium environmental release fraction for mitigated low density moderate leak (OCP1)**

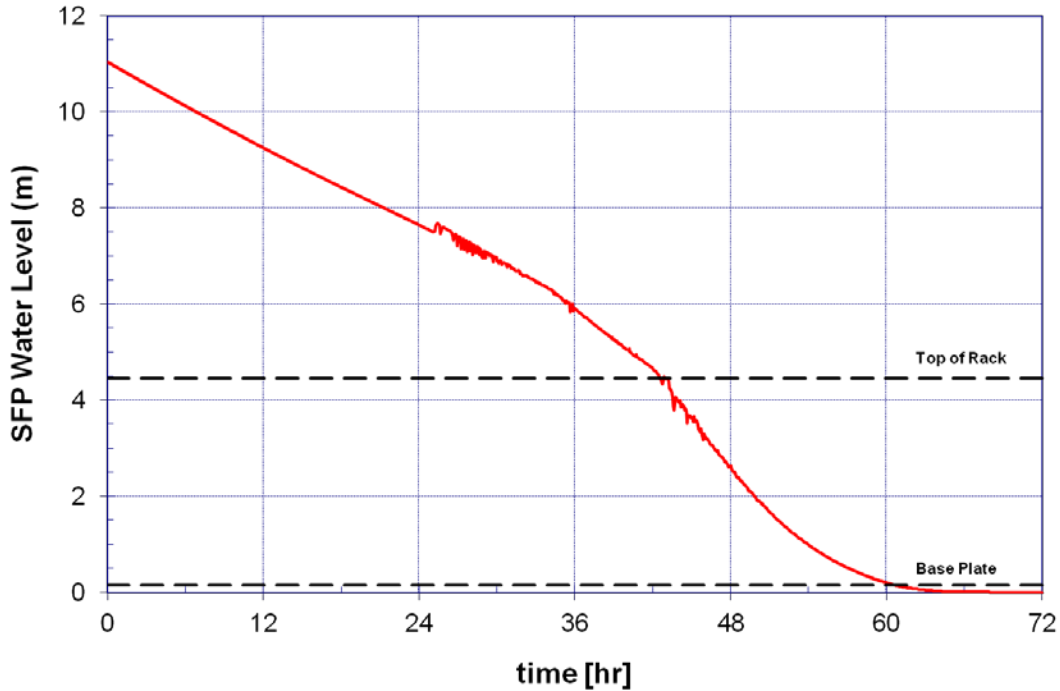
Unsuccessful Deployment of Mitigation for Small Leak (OCP2) Scenario

This scenario involves a hydrogen combustion that caused a late rapid air oxidation. Figure 81 shows the slow draindown of the pool exposing the top of the racks at 42.6 hours compared to 18.7 hours for postoutage scenarios (see Figure 54). Figure 82 illustrates the decay power and the oxidation power. The air oxidation power reaches an order of magnitude higher than the decay heat during the oxidation transient after 60 hours. The fuel heatup begins after the water level reaches about the fuel midplane (see Ring 1 response in Figure 83). The high-temperature fuel in Ring 1 heats the surrounding low decay heat fuel in Ring 2, as shown in Figure 84.

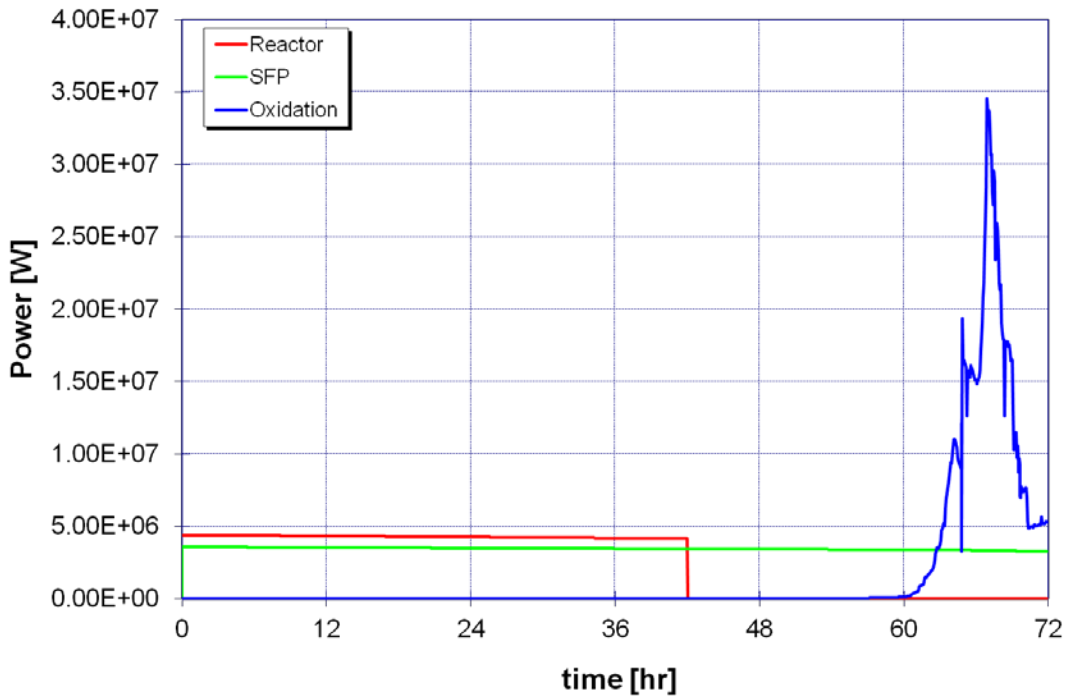
The evolution of reactor building steam and air shows that, by the time the water level reached the SFP gate and the SFP is disconnected from the reactor, the building is filled with steam which continues to decrease as it is condensed on structures. The hydrogen concentration builds up until it reaches 10 percent at 65 hours and combusts. At the time of combustion, all the necessary conditions are satisfied; the hydrogen concentration is 10 percent, the oxygen is 10 percent, and the steam is less than the 55-percent threshold for inerting. The hydrogen combustion is sufficient to fail the blowout panels and the roof allowing fresh air to enter the refueling room. The fresh air circulates into the SFP, which leads to a rapid fuel heatup and failure in Ring 1 and then in Ring 2. The reactor building decontamination factor approaches unity (Figure 86) resulting in about a 17-percent cesium release to the environment (Figure 87).

The response for the low-density case was similar to, but less severe than the high-density case. The spacing of the fuel with empty rack cells reduced the propensity for propagation of the heat from the highest decay heat assemblies to the other assemblies in the SFP. Figure 88 shows the response of the highest decay heat assemblies in Ring 1. The peak fuel

temperatures were less than 1,400 K. As shown in Figure 89, the fuel in Ring 3 had a similar response, but the fuel in Ring 5 was substantially lower. Fewer fuel assemblies and lower peak temperatures resulted in less oxidation and less hydrogen generation. The peak hydrogen concentration was well below the threshold for combustion. The overall cesium release is an order of magnitude lower (1.7 percent) than in the high-density case.



**Figure 81 Water level for unmitigated high-density small leak (OCP2)**



**Figure 82 SFP power for unmitigated high-density small leak (OCP2)**



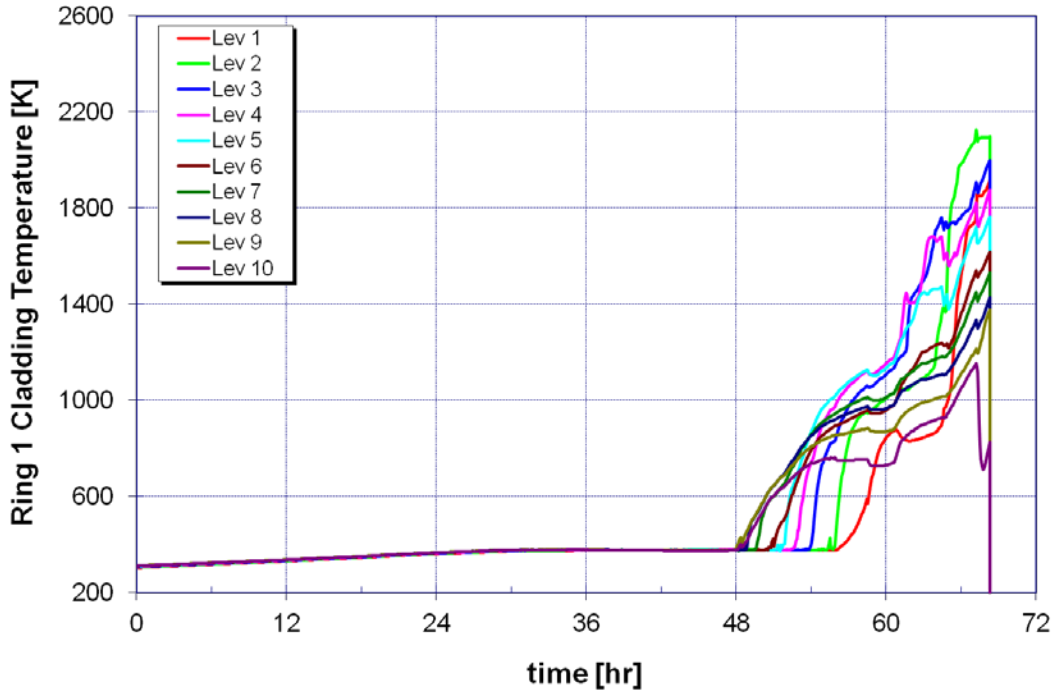


Figure 83 Ring 1 clad temperature for unmitigated high-density small leak (OCP2)

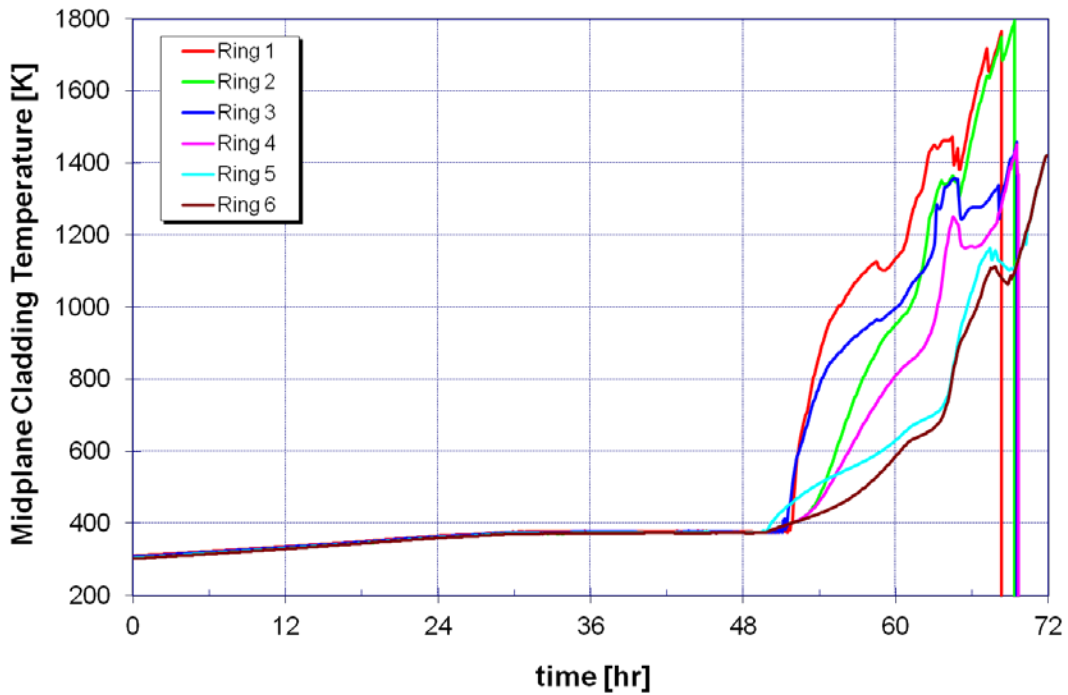


Figure 84 Midplane clad temperature for unmitigated high-density small leak (OCP2)

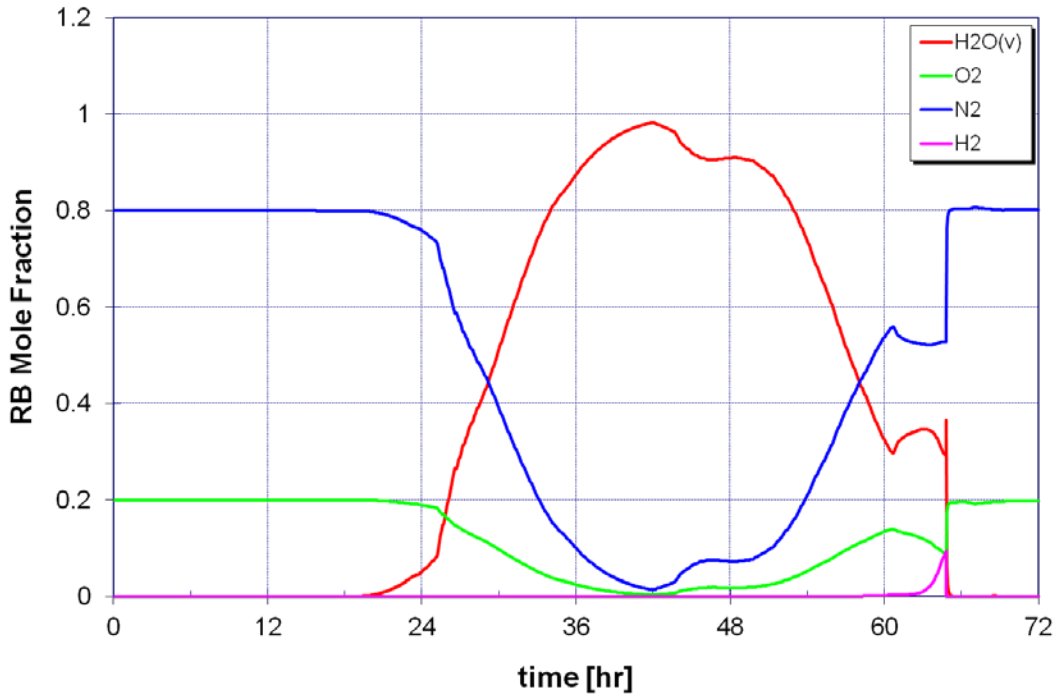


Figure 85 Reactor building mole fraction for unmitigated high-density small leak (OCP2)

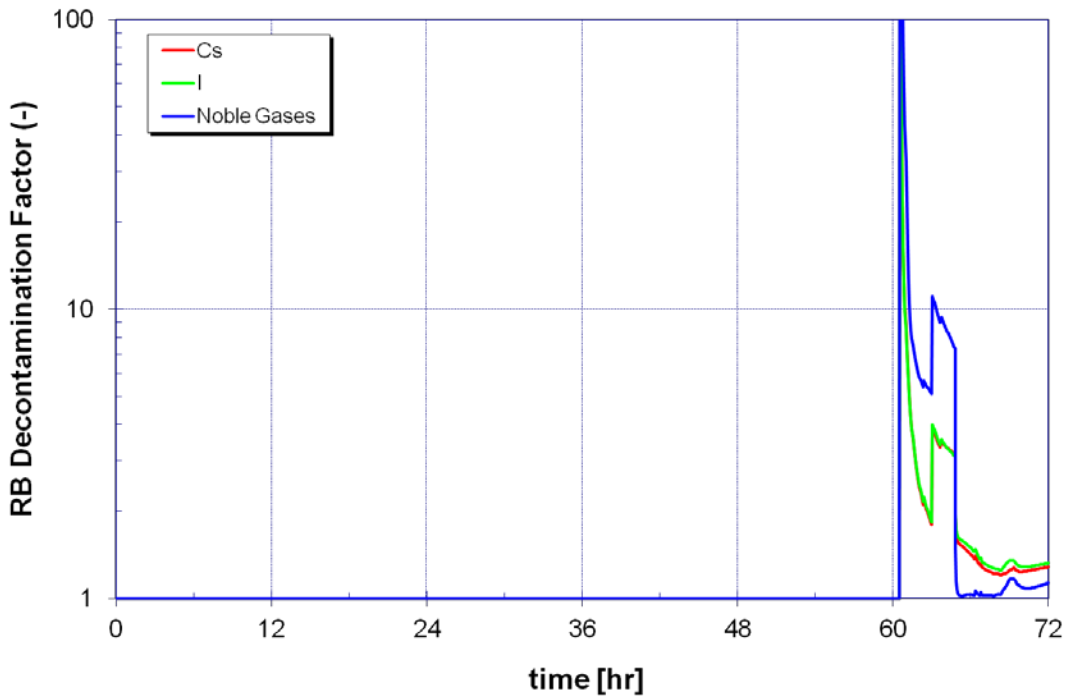
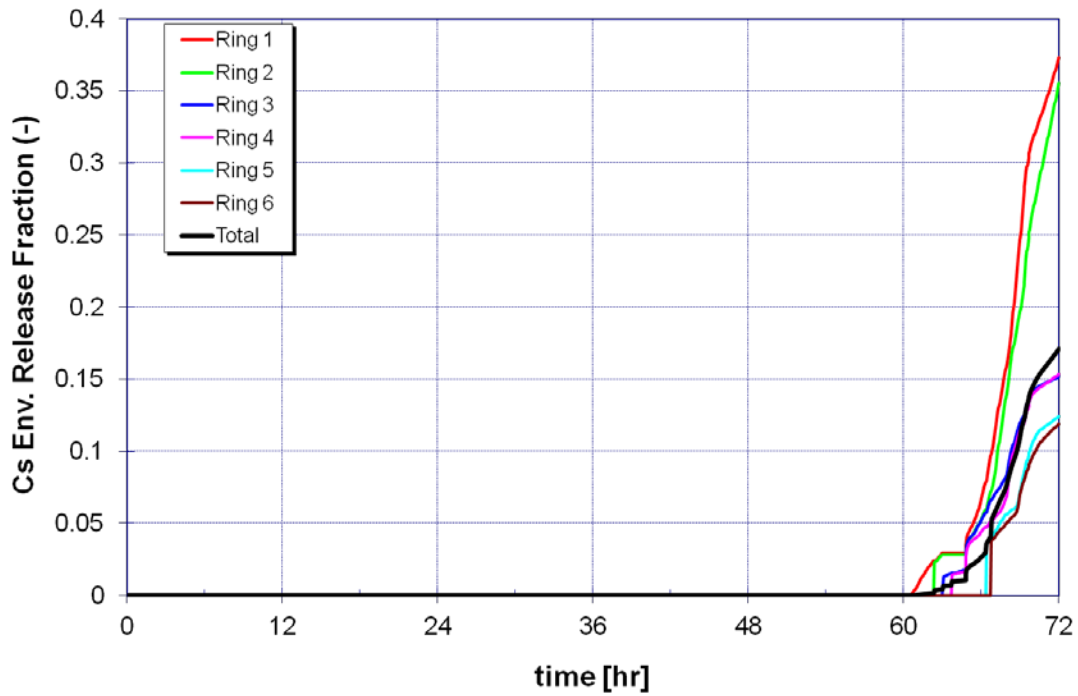
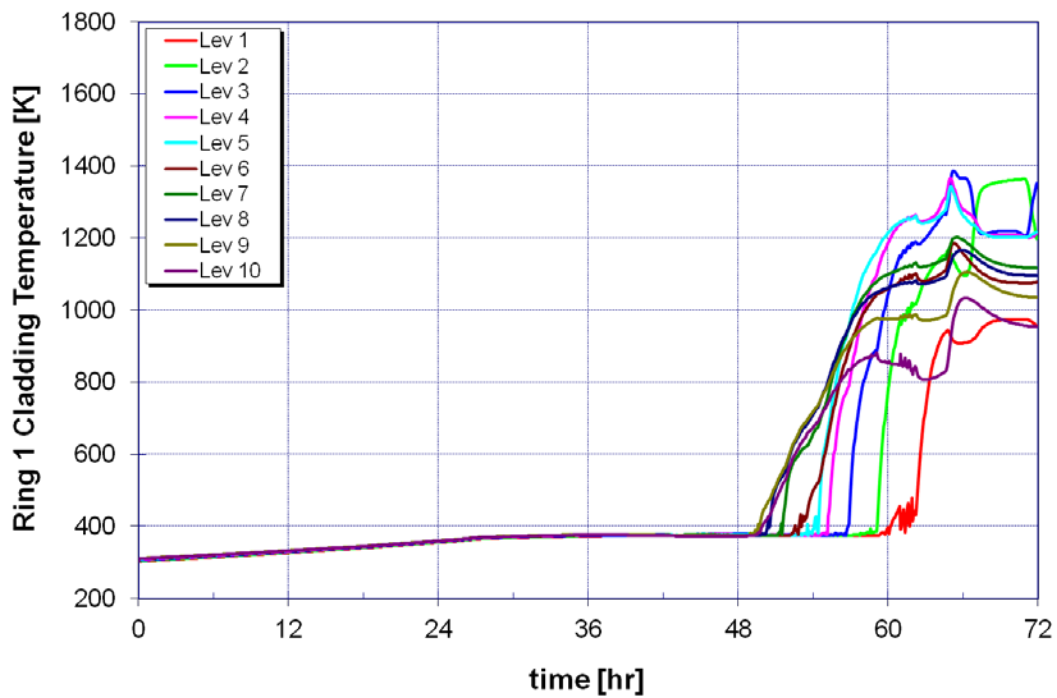


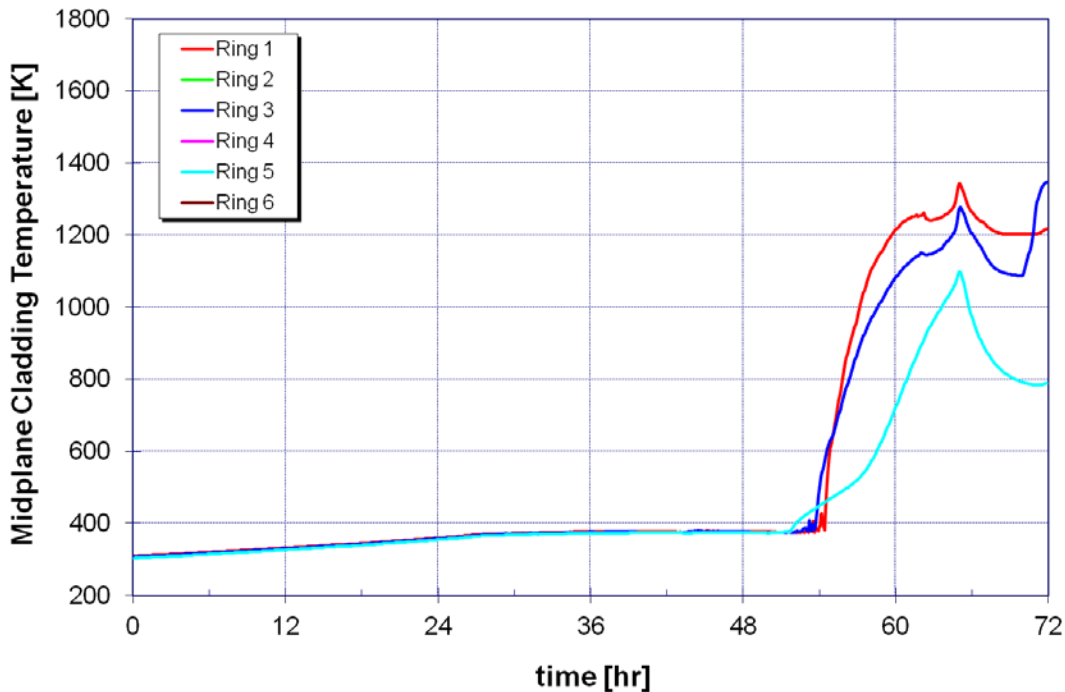
Figure 86 Reactor building DF for unmitigated high-density small leak (OCP2)



**Figure 87 Cesium environmental release fraction for unmitigated high-density small leak (OCP2)**



**Figure 88 Ring 1 clad temperature for unmitigated low-density small leak (OCP2)**



**Figure 89 Midplane clad temperature for unmitigated low-density small leak (OCP2)**

Unsuccessful Deployment of Mitigation for Moderate Leak (OCP3) Scenario

Figure 90 (compare to Figure 67 for OCP1) depicts the response of the fuel temperature in Ring 1. The heatup starts sooner because there is less water to drain and the approach to a zirconium fire is more gradual because of lower decay heat (i.e., by a factor of 2.5—see Table 25) and the natural circulation of air through the assemblies. However, once the zirconium fire is started, the maximum temperatures are comparable in both cases. As shown in Figure 90, the zirconium fire starts at Level 5 but then moves slowly to Level 4, Level 3, and Level 2. After the peak temperature at Level 4, the peak temperature in the zirconium fire front decreases with each successive level. Radial heat transfer from the fuel racks to the SFP wall (Figure 91), the buildup of the oxide layer on the fuel, and the depletion of the oxygen in the reactor building (Figure 92) cause the clad temperature to decrease. After 24 hours, the fuel temperatures in Ring 1 are relatively stable. There was no hydrogen combustion in this calculation. When the hydrogen concentration peaks at 8 percent, the oxygen concentration is only 3 percent (well below an amount sufficient for combustion as shown in Figure 92).

Figure 93 shows the temperature profiles for the low-density case.. The low-density temperatures are about 400 K lower than the high-density case, with the total cesium release being about 0.1 percent compared to 0.7 percent in the high-density case. Similar to the previous OCP2 case, the low amount of fuel and the empty rack cells reduced the magnitude of hydrogen and the cesium release. A sensitivity analysis was performed to examine the effect of higher vapor pressure for the air-oxidizing ruthenium releases. Figure 94 (the default ruthenium release model) and Figure 95 (the enhanced ruthenium release model used in the present

study) show that the ruthenium release differs by an order of magnitude.<sup>37</sup> All the calculations with moderate leaks were based on the enhanced ruthenium release model.

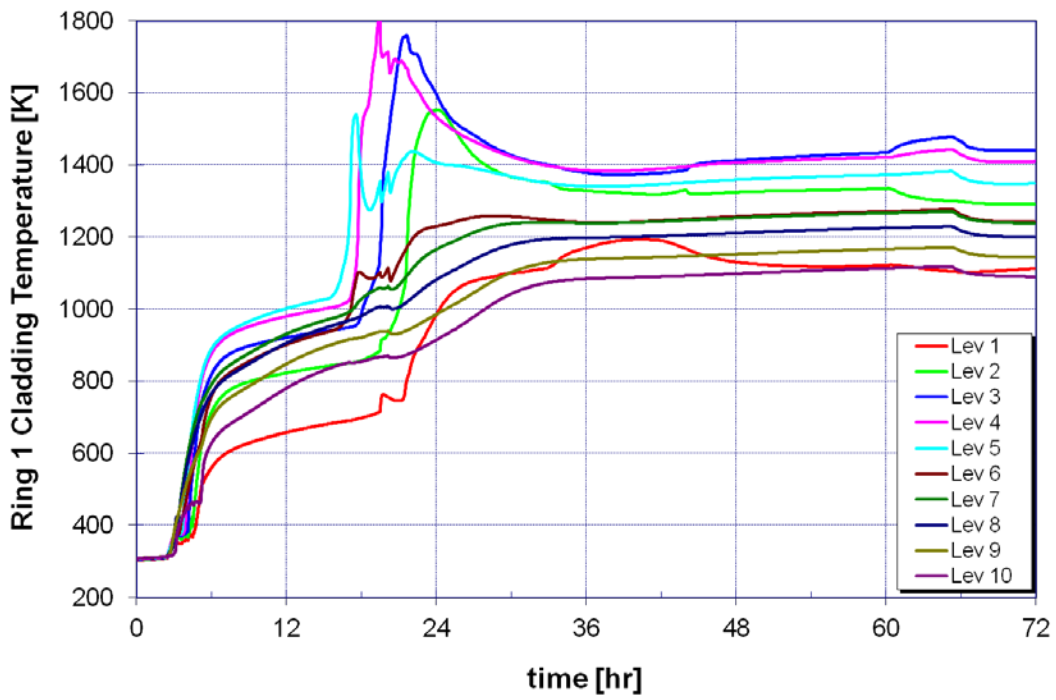


Figure 90 Ring 1 clad temperature for unmitigated high-density moderate leak (OCP3)

<sup>37</sup> However, ruthenium release differences could be higher for scenarios in OCP1 and OCP2.

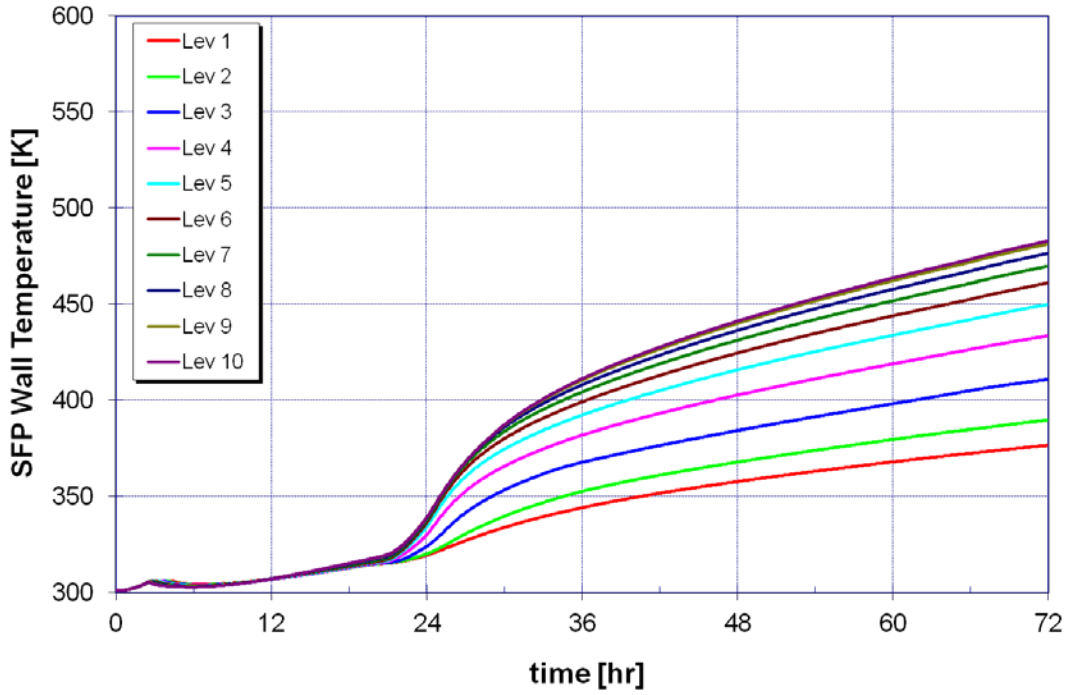


Figure 91 SFP wall liner temperature for unmitigated high-density moderate leak (OCP3)

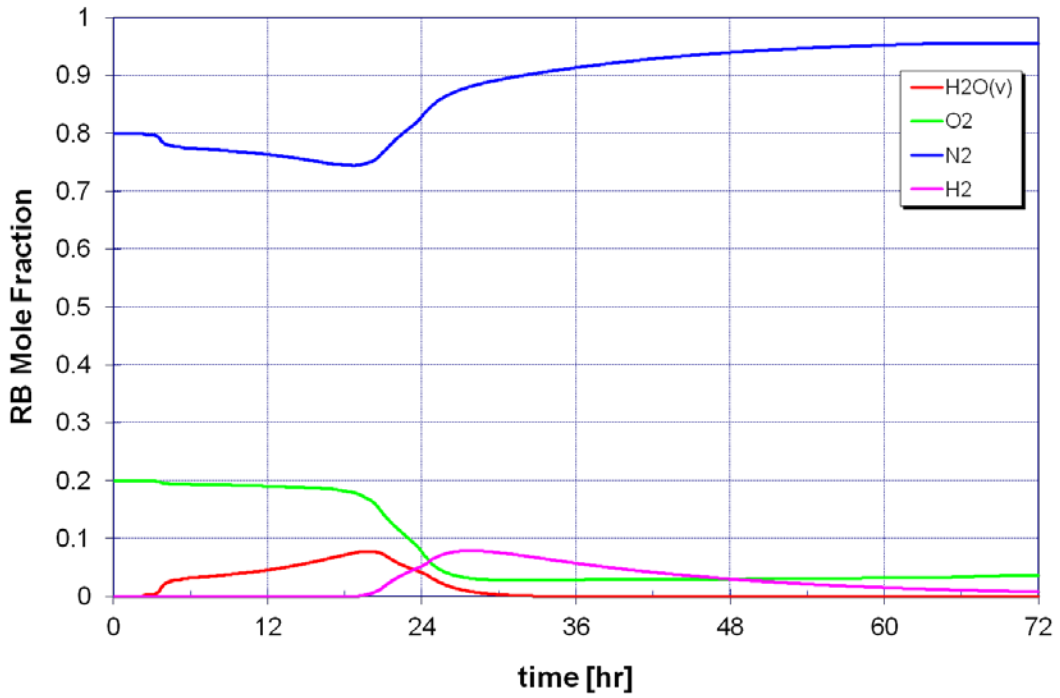


Figure 92 Reactor building mole fractions for unmitigated high-density moderate leak (OCP3)

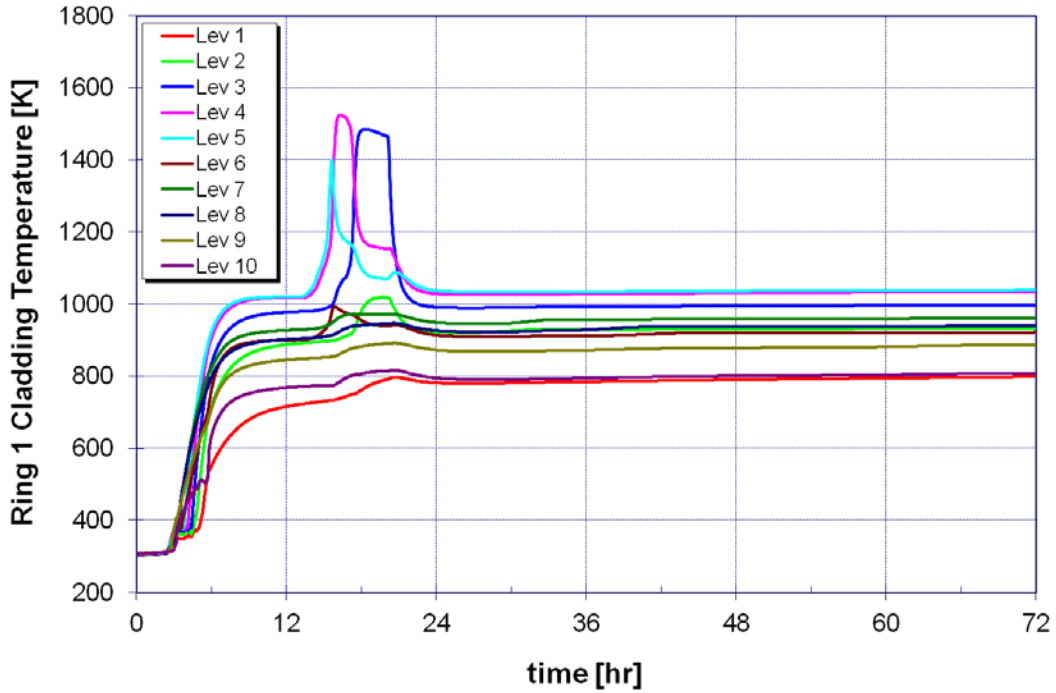


Figure 93 Ring 1 clad temperature for unmitigated low-density moderate leak (OCP3)

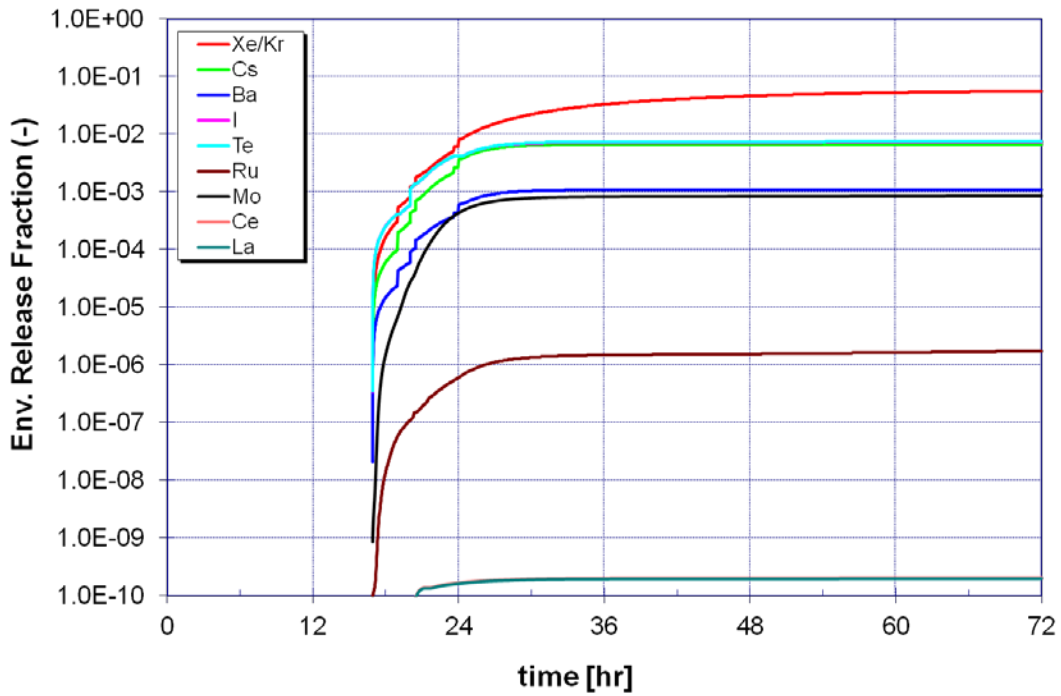
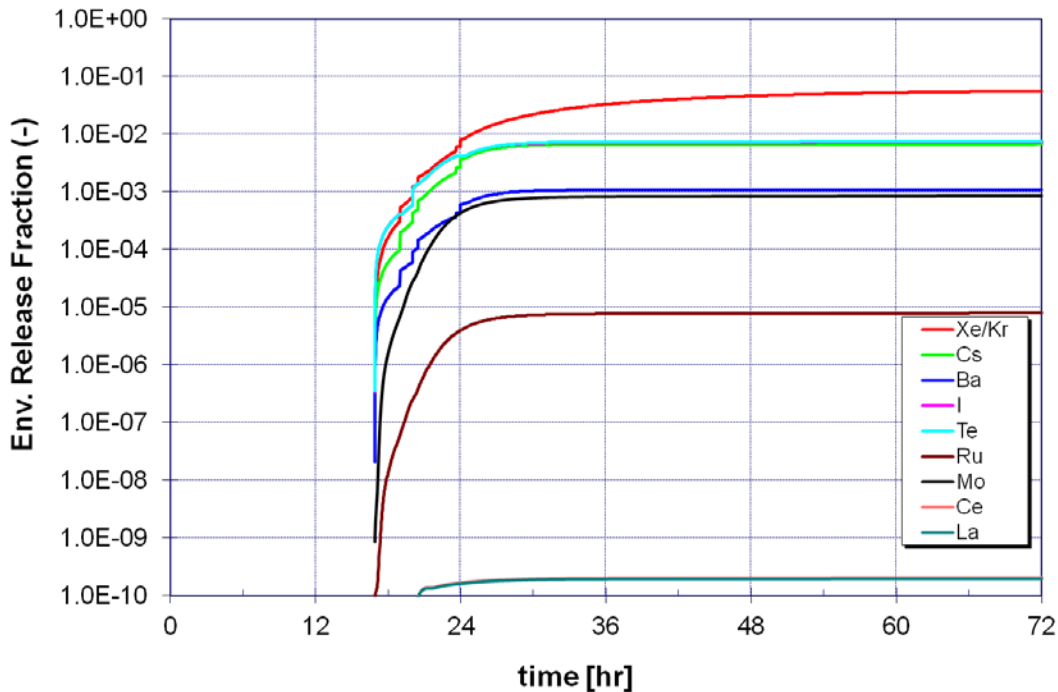


Figure 94 MELCOR default ruthenium release for unmitigated high-density moderate leak (OCP3)



**Figure 95 MELCOR enhanced ruthenium release under air oxidizing conditions for unmitigated high density moderate leak (OCP3)**

### 6.3.3 Source Terms for Offsite Consequence Analysis

Table 27 summarizes the release characteristics and key events for the high-density scenarios, and Table 28 summarizes these factors for the low-density scenarios. Previous sections of this report provided a more detailed discussion of key phenomena for selected sequences. The releases are binned for offsite consequence analysis, which Section 7 describes.

For the high-density loading, all of the mitigated scenarios (except OCP1) have no release, either because the makeup exceeds the leak rate, as in the small leak cases, or the mitigation is successful in limiting the fuel heatup and avoiding gap release. All the scenarios that do not involve a hydrogen deflagration have relatively low releases since the depletion of the oxygen limits clad oxidation and fuel heatup. A building failure results in air ingress into the assemblies and late-phase rapid oxidation.

None of the scenarios in the low-density cases had hydrogen combustion, and the releases were relatively small. In the absence of hydrogen deflagration, the release fractions for both high-density and low-density cases are generally comparable. One exception is the low-density OCP1 cases which had higher release fractions than the high-density cases in some instances. This difference resulted from more rapid heatup of the fuel in Ring 1 because of less efficient heat transfer to the outer assemblies. As shown above, the inventories in the low-density configuration are lower and, for the same release fractions, the released activity would be lower. Overall, for the moderate leaks, the low-density cases lead to earlier gap release because of a larger inventory of water (assemblies removed) resulting in longer times for clearing the baseplate. The gap release first occurs in Ring 1 (hot assemblies), which has the same decay heat in both high-density and low-density configurations.



#### 6.3.4 Accumulation of Water Elsewhere in the Reactor Building

There are approximately 50 floor drains on the refueling floor, both at floor level and in the lower, recessed areas of the floor. The two stair towers are fully enclosed and will not be subjected to condensation. The doors to the stair towers are secondary containment doors, and so they have air seals (weather stripping, but not watertight seals). The open crane hatch in the refueling floor has a surrounding 6-in. (0.15-m) curb, so condensation on the floor will run to the floor drains and not the hatch. However, condensation forming directly over the hatch, which is 17 ft 0 in. (5.2 m) by 21 ft 9 in. (6.6 m), will fall to Elevation 135 ft (41.2 m). There is a 4-in. (0.1-m) floor drain directly under the hatchway at Elevation 135 ft (41.2 m), with no equipment in the footprint of the hatch.

If the stainless steel liner plate and 6-ft- (1.83-m-) thick reinforced concrete slab of the SFP leak through, the water will fall onto Elevation 165 ft (50.3 m) of the reactor building. Directly beneath the SFP on Elevation 165 ft (50.3 m) are the three fuel pool cooling pumps, the three fuel pool cooling heat exchangers, and the three fuel pool service water booster pumps. There are several floor drains in this area. Equipment adjacent to this area that could be affected by a large volume of water includes the fuel pool equipment panel and the reactor level and pressure instrument racks. If the floor drains on Elevation 165 ft (50.3 m) cannot keep up with the flow, then the alternate flow paths would be the crane hatch or the door to each of the two stair towers, having the same configuration as described for the refueling floor above. A significant flow rate could also affect the emergency auxiliary load centers on Elevation 165 ft (50.3 m). Water flowing over the curb of the crane hatch would reach Elevation 135 ft (41.2 m), where it would either enter the floor drains, flow through the grating to the torus room floor, or exit the building under the doors of the equipment access lock. Water reaching the stair towers would travel to the bottom of the stair tower. Water in the W stair tower would reach the residual heat removal pump room which has its own floor drains (procedurally controlled, normally closed) and sump pump. Water in the east stair tower would reach the core spray pump room or elevator shaft bottom which have floor drains (procedurally controlled, normally closed) that run to the reactor building main sump.

The reactor building MELCOR model is simplified (see Figure 42). Therefore, all water leakages corresponding to the SFP damage and draindown and overflow from water accumulation from condensation are directed to the environment. The model does not track the flow of the water and accumulation in other parts of the reactor building.

**Table 27 Summary of Release Characteristics for High-Density Scenarios**

High Density Case #	Scenario Characteristics					Release Characteristics			
	SFP Leakage?	50.54(hh)(2) Equipment?	Fuel Uncovery (hr)	Gap Release (hr)	Hydrogen Deflagration (hr)	Cs release at 72 hours	Cs-137 (MCi) Released	I release at 72 hours	I-131 (MCi) Released
OCP1	None	Yes							
	None	No							
	Small	Yes							
	Small	No	39.7	54.2	No	0.6%	0.33	3.5%	0.27
	Moderate	Yes	7.4	15.1	No	0.5%	0.26	5.0%	0.39
	Moderate	No	5.9	8.7	No	1.5%	0.80	2.1%	0.16
OCP2	None	Yes							
	None	No							
	Small	Yes							
	Small	No	42.6	60.5	64.8	17.1%	7.90	17.1%	1.91
	Moderate	Yes							
	Moderate	No	5.9	11.6	No	1.6%	0.73	2.0%	0.22
OCP3	None	Yes							
	None	No							
	Small	Yes							
	Small	No	18.7	40.6	47.3	42.0%	24.20	51.2%	0.73
	Moderate	Yes							
	Moderate	No	2.5	16.9	No	0.7%	0.39	0.7%	0.01

**Table 28 Summary of Release Characteristics for Low-Density Scenarios**

Low Density Case #	Scenario Characteristics					Release Characteristics			
	SFP Leakage?	50.54(hh)(2) Equipment?	Fuel Uncovery (hr)	Gap Release (hr)	Hydrogen Deflagration (hr)	Cs release at 72 hours	Cs-137 (MCi) Released	I release at 72 hours	I-131 (MCi) Released
OCP1	None	Yes							
	None	No							
	Small	Yes							
	Small	No	40.3	54.7	No	3.1%	0.33	4.6%	0.36
	Moderate	Yes	7.4	12.6	No	1.8%	0.19	7.0%	0.55
	Moderate	No	5.9	8.7	No	0.5%	0.05	1.7%	0.13
OCP2	None	Yes							
	None	No							
	Small	Yes							
	Small	No	43.1	59.2	No	1.7%	0.28	3.3%	0.37
	Moderate	Yes							
	Moderate	No	5.9	10.5	No	0.4%	0.07	0.7%	0.08
OCP3	None	Yes							
	None	No							
	Small	Yes							
	Small	No	18.8	41.6	No	0.6%	0.10	1.2%	0.02
	Moderate	Yes							
	Moderate	No	2.5	15.2	No	0.1%	0.02	0.2%	0.00

## 7. OFFSITE CONSEQUENCE ANALYSIS

In the unlikely event of a severe accident that might damage the SFP (as detailed in the previous sections), a release of radioactive material from the nuclear power plant site into the atmosphere could occur. Such a release of radioactive material is expected to disperse from the site through the atmosphere and to the surrounding population, by expanding and moving downwind. After modeling the onsite accident progression and potential mitigation measures, the MELCOR Accident Consequence Code System, version 2 (MACCS2) code is used to model offsite release and consequences of radioactive material. MACCS2 (SNL, 1997) has been developed by SNL for the NRC over the past two decades. It has the ability to evaluate the impacts of atmospheric releases of radioactive aerosols and vapors on human health and on the environment. The MACCS2 code can use site-specific weather conditions, population data, and evacuation plans to calculate and model the radiation exposure of the population through all of the relevant dose pathways—cloudshine, inhalation, groundshine, and ingestion. Along with MACCS2, SNL has also developed WinMACCS for the NRC. WinMACCS is a user friendly graphical interface to MACCS2 that facilitates selection of input parameters and sampling of uncertain input parameters and performs post processing of results.

MACCS2 rev. 3.7.0 was used for the offsite consequence analysis in this study. In addition, many of the input values for offsite release and consequence modeling are based on approaches developed in the “State-of-the-Art Reactor Consequence Analyses” research project (NUREG-1935). These approaches are documented in greater detail in NUREG/CR-7009, “MACCS2 Best Practices as Applied in the State-of-the-Art Reactor Consequence Analyses Project”, (expected to be published in 2013), The modeling for NUREG-1935 was, in turn, based on previous studies such as NUREG-1150, an expert elicitation of the NRC/Commission of the European Communities (CEC) to update certain transport and dose parameters in NUREG/CR-7161 (NRC, 2013), and an update of the dose coefficients and dose-response modeling to be consistent with the latest Federal guidance report (FGR) at the time (FGR-13, “Cancer Risk Coefficients for Environmental Exposures to Radionuclides,” issued in 2002 (EPA, 2002)). Differences between the approaches used in NUREG-1935 and the approaches used in this study are documented below.

### 7.1 Offsite Consequence Modeling

#### 7.1.1 Radiological Source Term

A source term definition for MACCS2 was created for each accident consequence calculation. The activity levels of different radionuclides from the fuel in the pool were supplied by ORIGEN calculations. The physical state of the plume, including information on the chemical group release rates, aerosol size distributions, density, and mass flow rate was supplied by MELCOR. The MELCOR analyses provided a release rate for each chemical group. Because the amount of release may differ for different sections of the pool, a new methodology was developed for this study to account for the distribution of radionuclides in the pool as well as radionuclide-specific release magnitudes. For instance, recently discharged fuel, which has more short-lived radionuclides, is more likely to release before and to greater magnitudes than older fuel. This process is described in more detail in Section 6.1.5.

Because explicit modeling with MACCS2 of all release sequences generated by MELCOR analyses is computationally expensive, the MELCOR sequences were binned by their Cs-137 and I-131 release activities (see Table 29). The first criterion used to bin the sequences was

Cs-137 release, because Cs-137 is the most significant contributor to long-term consequences. I-131 was also chosen as a criterion to bin the sequences, because I-131 is a good indicator for short-lived radionuclides that may be released from recently discharged spent nuclear fuel. The tally into each of these bins can be seen in Table 30.

**Table 29 Release Category Types**

Release Category Binning		Cesium-137 Release Activity (MCi)		
		0 to 0.5	0.5 to 5	5+
Iodine-131 Release Activity (MCi)	0 to 0.25	RC11	RC21	RC31
	0.25 to 0.55	RC12	RC22	RC32
	0.55+	RC13	RC23	RC33

**Table 30 Release Category Tally**

Release Category	RC11	RC12	RC13	RC21	RC22	RC23	RC31	RC32	RC33	Total
Sequence Tally	5	5	0	2	0	0	0	0	2	14

One sequence was chosen from each bin (not including bins with no contributing accident sequences) to represent the entire release category, and the offsite consequences of these sequences were analyzed. The study considered a number of different factors to determine which sequence should represent each bin, including the release frequency, the relative Cs-137 and I-131 release for the bin, the start time of release, the SFP loading configuration, and the availability of the source term data (some accident progression calculations were still ongoing at the time the selection was made). In addition, because of the significant differences in release category 33 relative to the other bins, both of these sequences were analyzed, as identified in Table 31. Then, based on their conditional probabilities, all the main MELCOR sequences and their associated consequences were applied to the scenarios reported in the results, which are high-density and low-density loading both with and without successfully deployed 10 CFR 50.54(hh)(2) equipment. Sequences with no release were not included, as they do not have offsite consequences. Section 6.3 contains more information regarding which sequences do and do not have a release. For all sequences, successful deployment of 10 CFR 50.54(hh)(2) equipment prevents release of radioactive material, except for a moderate size leak during OCP1 (as defined in Section 5.2), which is when newly discharged fuel is first loaded from the reactor. Without successful deployment of 10 CFR 50.54(hh)(2) equipment, the predicted scenario-specific release frequency is  $10^{-7}$  per year.

**Table 31 Listing of Scenario-specific Release Sequences**

High Density (1x4) Fuel Loading											
Unsuccessful mitigation				Deployed 50.54(hh)(2)							
Sequence		Release Frequency (/yr)	Release Category	Sequence		Release Frequency (/yr)	Release Category				
OCP1	small leak	6E-09 <sup>(2)</sup>	RC12*	OCP1	mod leak	6E-09	RC12				
	mod leak	6E-09	RC21								
OCP2	small leak	2E-08	RC33*	No Release							
	mod leak	2E-08	RC21*								
OCP3	small leak	4E-08	RC33*								
	mod leak	4E-08	RC11								
Total		1E-07						Total		6E-09	
Low Density Fuel Loading											
Unsuccessful mitigation				Deployed 50.54(hh)(2)							
Sequence		Release Frequency (/yr)	Release Category	Sequence		Release Frequency (/yr)	Release Category				
OCP1	small leak	6E-09	RC12	OCP1	mod leak	6E-09	RC12				
	mod leak	6E-09	RC11								
OCP2	small leak	2E-08	RC12	No Release							
	mod leak	2E-08	RC11								
OCP3	small leak	4E-08	RC11*								
	mod leak	4E-08	RC11								
Total		1E-07						Total		6E-09	

<sup>1</sup> Release frequency = initiating event frequency \* ac power fragility \* OCP probability \* liner fragility for the specified leak size (see Section 5.6.3 for conditional probabilities)

<sup>2</sup> Example calculation:  $1.7 \times 10^{-5} / \text{yr} \cdot 0.84 \cdot 0.0086 \cdot 0.05 = 6 \times 10^{-9} / \text{yr}$

\* Sequences marked with an (\*) were used in MACCS2 analysis

### 7.1.2 Atmospheric Modeling and Meteorology

The atmospheric transport and dispersion model in MACCS2 is a straight-line Gaussian plume segment dispersion model. For this study, the atmospheric release of radionuclides is discretized into (at longest) 1-hour plume segments. This accounts for variations in the release rate, as well as for changes in wind direction. More plume segments increase the resolution of the dispersion modeling to the point the resolution corresponds to the time resolution of the weather data, because each segment can travel in a compass direction representative of the actual weather data at the time the plume segment is released.

A set of aerosol deposition velocities, combined with the aerosol size distribution from MELCOR, determines the rates aerosols are deposited from the plume to the ground. Generally, the larger aerosols deposit more quickly and so are depleted more rapidly from the plume. The peak in the aerosol size distribution is usually a few microns in diameter, which corresponds to a deposition velocity of about 4 or 5 millimeters per second. Dry deposition velocities have been updated to account for a more typical surface roughness of 60 cm for the reference plant site. (A surface roughness of 10 cm was used for NUREG-1935 and a 60-cm surface roughness was considered in a sensitivity calculation.) The relative aerosol deposition

velocities, as well as much of the non-site-specific data for acute health effects, are developed from NUREG/CR-7161 (NRC, 2013).

Because the exact weather conditions that would apply in the case of a potential accident in the future cannot be known in advance, MACCS2 accounts for weather variability by analyzing a statistically significant set of weather trials. Thus, the modeled results are ensemble averages of weather that represent of the full spectrum of meteorological conditions. The weather-sampling strategy for this study uses a nonuniform weather-binning approach. Weather binning is an approach used in MACCS2 to categorize similar sets of weather data based on windspeed, stability class, and the intensity and timing of precipitation. This sampling strategy was chosen to represent the statistical variations of the weather. Further discussion on this approach can be found in NUREG/CR-7009.

Meteorological data used for this project consisted of one year of hourly meteorological data (8,760 data points for each meteorological parameter). The data are from onsite meteorological tower observations are the same as those used in NUREG-1935. The site selected for the reference plant provided two years of weather data, including directly measured hourly precipitation data. Stability class data were derived from temperature measurements at two elevations on the site meteorological towers. The specific year of meteorological data chosen for the reference plant was 2006, which was based on data recovery (greater than 99 percent being desirable) as documented in NUREG/CR-7009. Different trends (e.g., wind rose pattern and hours of precipitation) between the years were estimated to have a relatively minor (less than 25 percent) effect on the final NUREG-1935 results. More specific details of the weather data can be found in NUREG/CR-7009.

### **7.1.3 Exposure, Dosimetry, and Health Effects Modeling**

MACCS2 considers groundshine, cloudshine, inhalation, and ingestion exposure pathways. The principal exposure pathway to members of the public occupying land contaminated by atmospheric deposition of radioactive materials is expected to be exposure of the whole body to external gamma radiation. Although it is normally expected to be of lesser importance, the inhalation pathway contributes additional doses to internal organs (EPA, 1992), especially during the emergency phase of the accident. The MACCS2 outputs for health effects and population dose include doses from exposure via the ingestion pathway. However, the MACCS2 code does not represent these consequences in the individual LCF risk results<sup>38</sup>. Food ingestion parameters were chosen to be consistent with Sample Problem A, as documented in NUREG/CR-6613, Vol. 1 (Chanin and Young, 1998). Sample Problem A is based on NUREG-1150, with the exception that newer options not included in the older MACCS model were used to demonstrate new capabilities in MACCS2 (e.g., that the food ingestion model is updated to use the newer COMIDA2 rather than the original MACCS food-chain model). NUREG-1935 did not include exposure to contaminated food because staff judged it not to be a significant contributor to individual risk.

NUREG/CR-7009 reviews the shielding factors applied to evacuation, normal activity, and sheltering for each dose pathway (e.g. groundshine) used in NUREG-1150 (NRC, 1990) and NUREG/CR 6953, Volume 1, "Review of NUREG-0654, Supplement 3, 'Criteria for Protective Action Recommendations for Severe Accidents'—Focus Group and Telephone Survey," issued

---

<sup>38</sup> Including the ingestion pathway is predicted to increase health effect risks in this study by about 5% with an LNT dose response model, depending on the scenario.

October 2008 (NRC, 2008c). This study uses the same shielding factors as updated in NUREG/CR-7009.

The site file containing population and economic data was created for 16 compass sectors and then interpolated onto a 64 compass-sector grid for better spatial resolution for the consequence analysis. Site population data have been projected to the target year 2011 using the latest version of the computer code SECPOP2000 (SNL, 2003). SECPOP2000 uses 2000 census data and applies a multiplier to account for population growth and an economic multiplier to account for the value of the dollar to create site data for MACCS2. A multiplier value of 1.1051 from the U.S. Census Bureau was used to account for the average population growth in the United States from 2000 to 2011. Consistent with the approach used in NUREG-1935, the economic values from the database in SECPOP2000 (which uses an economic database based on the year 2002) were scaled to account for price escalation between the years 2002 and 2011. A scaling factor of 1.250 was derived based on the Consumer Price Index (CPI).

Consistent with NUREG-1935, the dose and risk coefficients and relative biological effectiveness values used in this study are based on FGR-13 (EPA, 2002). The dose coefficients allow organ-specific doses to be calculated from exposure to radiation. The risk factors in FGR-13 are based on the risk coefficients for the U.S. population detailed in the BEIR V report (NAS, 1990). As implemented in MACCS2, these factors include seven organ-specific cancers plus residual cancers not accounted for directly. The inhalation factors in FGR-13 were processed to account for a distribution of particle sizes. An activity median aerodynamic diameter of 1 micron was assumed with a log-normal form for the distribution and with a geometric standard deviation of about 2.5. Parameters that relate to acute health effects in this study, as well as much of the nonsite-specific data used for consequence analysis were taken from NUREG/CR-7161 (NRC 2013). All of the input parameters extracted from the expert elicitation are median values.

The FGR-13 coefficients, as implemented in MACCS2, include a dose and dose rate effectiveness factor (DDREF), which has been incorporated in the dose-response modeling for the long-term phase of the offsite consequences and to the dose-response modeling for the early-phase (i.e. the first week) for doses less than 20 rem. This factor accounts for the fact that protracted, low doses are estimated to be less effective in causing cancer than more acute doses. The DDREFs for all cancer types, except for breast, were 2.0; the DDREF for the breast was 1.0, as in NUREG/CR-7009.

To provide perspective on uncertain low-dose health effects, the results also include dose truncations that limit the quantified health effects to those arising from higher doses. Dose truncation values used here include 620 mrem/year (representative background radiation including average annual medical exposures), and 5 rem/year with a 10-rem lifetime cap (based on the Health Physics Society's position that there is a dose below which, because of uncertainties, a quantified risk should not be assigned). This approach is consistent with the approach used in NUREG-1935.

#### **7.1.4 Emergency Response Modeling**

The MACCS2 models were set up to calculate exposures in two distinct phases: the emergency phase and the long-term phase. The emergency-phase models calculate the dose and associated health effects to the public, as well as the effects of emergency preparedness



actions that protect the public. The emergency phase is defined as the seven day period following the start of the release.

The staff modeled offsite response organization (ORO) decision making based upon the accident sequences, timing, radiological release, and knowledge of response activities and the availability of emergency response technical support. Since actions beyond the emergency planning zone (EPZ)<sup>39</sup> would be ad hoc, there is no procedural guidance or exercise performance documentation upon which to base assumptions. However, state and local OROs have shown long standing capability and understanding of response to hypothetical radiological accidents. The accidents modeled in the SFPS are slow to develop relative to the accident scenarios used in evaluated exercises. Additionally, there would be national level assistance to help civil authorities with protective action decision making. While alternative timing could be assumed the staff used a best estimate approach to modeling ORO decision making for protective actions beyond the EPZ.

For each of the accident sequences, staff determined that a General Emergency would be declared promptly (within 15 minutes), based on the emergency action levels for the operating reactor. The timing of significant radiological release varied among the accident sequences and was an important factor in the response modeling. A release from a SFP with a moderate leak begins earlier than a damage state with a small leak, but these still do not begin until evacuation is well underway or completed within the EPZ.

A number of different protective actions can be modeled in MACCS2. The residents are modeled as groups (known as cohorts) and have different types of protective actions and associated response timings. The actions that can be taken include:

Shelter-in-place (SIP): For certain areas where dose may be reduced below the PAG through sheltering, SIP is modeled as an expected protective action consistent with the emergency plans. In other areas, sheltering can occur prior to evacuation.

General Public Evacuation: Residents evacuate the affected area when the official order to evacuate is received.

Early Evacuation: Residents evacuate after the earthquake, but before the official order to evacuate is received.

Shadow Evacuation: Residents evacuate from areas that are not under an official evacuation order. A shadow evacuation typically begins when a large scale evacuation is ordered (NRC, 2005b). In a national telephone survey of residents of EPZs, about 20 percent of people that had been asked to evacuate had also evacuated for situations in which they were asked not to evacuate (NRC, 2008c). In the SFP project, the initiating event is an earthquake that would be felt by residents of the EPZ. The event would be followed with media information related to an accident at the nuclear power plant, widespread loss of power and damage to some buildings. It was assumed that these factors would increase the shadow evacuation to 30 percent of the public in the environs of the plant.

---

<sup>39</sup> EPZ in this study refers to the plume exposure pathway EPZ with a radius of about 10 miles from the reactor site. This should not be confused with the ingestion exposure pathway EPZ with a radius of about 50 miles from the reactor site.

Hotspot and Normal Relocation: Models are included in the MACCS2 code to reflect emergency relocation of people from areas that were not included in the evacuation order where the dose exceeds emergency-phase PAGs. Within the MACCS2 calculation, individuals who would be relocated because their projected total committed dose is projected to exceed the protective action criteria are assumed to not receive any additional dose following relocation for the duration of the emergency phase. This relocation dose criterion is applied at a specified time after plume arrival within the affected area and is applied to the entire population within the analysis area, including the nonevacuating cohort (0.5% of the population) within the EPZ. The hotspot and normal dose and time values were developed for each evacuation model. They were established with the assumption that relocation begins after the evacuation is substantially complete which depends on the timing of the first plume for each sequence. For the larger release sequences which affect areas beyond 30 miles, the normal relocation time was assumed to be 12 hours after the hotspot relocation time. This assumption provides time for offsite response organizations to address the higher priority hotspot areas first.

The detailed emergency plans developed for the EPZ provide a substantial basis for expansion of response efforts if necessary (NRC, 1980a). This study identified many potential accident sequences and performed preliminary consequence modeling to establish baseline dose projections as a function of distance. This information was used to develop the appropriate emergency response parameters for the release being modeled. The distance to which the PAG may be exceeded assisted in determining the extent of offsite protective actions and the type of protective actions (sheltering or evacuation) that would be implemented. In the event of model predictions of elevated doses at distances beyond the plume exposure pathway EPZ, a review of the State emergency response plans was performed to determine the types of protective actions that would be implemented in these areas. The results of the dose projections were binned based on the EPA's PAGs (EPA, 1992) to support an efficient use of detailed consequence modeling to determine the potential effects of such accidents. For this analysis, the PAG was considered to be exceeded if the four day projected dose is expected to exceed one rem for a member of the public. Using the dose projections, the three evacuation models presented in the table below were developed for analysis. Detailed information on the implementation of these evacuation models is provided in APPENDIX A: .

**Table 32 Summary of Evacuation Models**

Evacuation Model	4-Day Dose Projection	EPZ	Area beyond EPZ
1	Small: Does not exceed PAG beyond EPZ.	General public evacuation, including early evacuation of 30% of the public.	Shadow evacuation of 30% of the public from immediately beyond the evacuation area. Hotspot relocation is 5 rem at 4 hours after plume arrival. Normal relocation is 1 rem at 8 hours after plume arrival.
2	Large (48 hour): Exceeds PAG beyond EPZ.	General public evacuation, including early evacuation of 30% of the public.	Shadow evacuation of 30% of the public from immediately beyond the evacuation area. Delayed evacuation to a distance of 30 miles. Shelter in place (SIP) for the 30 to 40-mile area. Shadow evacuation of 20% of the public from the SIP area. Hotspot relocation is 5 rem at 4 hours after plume arrival. Normal relocation is 1 rem at 16 hours after plume arrival. (Rapid implementation of relocation is based on having 48 hours to prepare before release begins)
3	Large (24 hour): Exceeds PAG beyond EPZ.	General public evacuation, including early evacuation of 30% of the public.	Shadow evacuation of 30% of the public from immediately beyond the evacuation area. Delayed evacuation to a distance of 30 miles. Shelter in place of 30 to 40-mile area. Shadow evacuation of 20% of the public from this Shelter-in-place (SIP) area. Hotspot relocation is 5 rem at 26 hours after plume arrival. Normal relocation 1 rem at 38 hours after plume arrival.

The population was divided into multiple cohorts to better represent the response of the public. A cohort is a population group that mobilizes or moves differently from other population groups. The site specific evacuation time estimate provides information on population characteristics, mobilization of the public, special facilities, transportation infrastructure and other information used to estimate the time to evacuate the EPZ. The evacuation time estimate was used to inform the development mobilization times and travel speeds for the public. To model evacuation in MACCS2, each cohort was loaded onto the roadway network at a specified time, and a set of speed values were applied per cohort for the early, middle and late periods of the evacuation. However, evacuations occur as a distribution in which the percent of public evacuating the area increases over time until all members of the public have evacuated. The rate of evacuating the public is typically represented as a curve that is relatively steep at the beginning and tends to flatten as the last members of the public exit the area. The point at which the curve tends to flatten occurs when approximately 90 percent of the population has evacuated. The last 10 percent of the population is called the evacuation tail (Wolshon, 2010) and was modeled as a separate cohort.

An assessment of travel distance and time was initially used to develop the speed of the general public cohorts. A distance of 13 miles was assumed as a maximum travel distance to provide for the fact that roadways are not necessarily oriented directly outward from the plant. Consistent with the location of the reference plant, the analysis includes the State of Pennsylvania position that, if an evacuation is ordered, it will include the entire EPZ. This position differs from other states, where evacuation of downwind areas would be implemented rather than the full EPZ. For this project, a full evacuation was modeled assuming that the offsite response organizations from neighboring states would adopt the same protective action decisions.

The following general assumptions were applied in this analysis:

- The EPZ is modeled as the area within 10 miles of the site, as an approximation.
- Protective actions would be implemented within the EPZ were an accident to occur.
- Protective actions would be expanded beyond the EPZ as necessary.
- Dose projections would be developed and available to support protective action decisions.
- Residents would expect they cannot return and would take more belongings with them, than what was considered in the past, e.g. NUREG/CR-7009, thereby increasing mobilization times.
- Residents would generally be aware of an impending emergency through media broadcasts.
- For the delayed release sequences in which a releases do not start for more than 24 hours, schools beyond the EPZ would be closed rather than evacuated.
- Evacuees are transported to safe distances.
- There is no loss of power beyond 20 miles. Communications, traffic signals, and emergency alert system messaging are not impacted in this area.

The chosen time period for the emergency phase begins with the initiating event and continues for one week following the initial release. This assumption gives time for the plume to pass and deposit radioactive material onto the ground so that all the calculated acute exposures are captured. The one-week period for the emergency phase is different than the four-day period used for emergency-phase dose projections, which were used to inform the evacuation models. The four-day period was chosen to be consistent with the EPA PAGs (EPA, 1992).

The roadway network within the EPZ was reviewed against the site-specific evacuation plan to determine the likely evacuation direction in each grid element. Travel directions were input at the grid level to approximate travel along evacuation routes and primary roadways. For evacuations beyond 20 miles, travel directions were chosen to be radially outward to simplify modeling of evacuation in these areas. Speed adjustment factors were applied at the grid element level to speed up vehicles in the rural uncongested areas and to slow vehicles in more urban settings in which the modeling indicates that speeds are lower than the average values used in the analyses.

The MACCS2 potassium iodide (KI) model used in this analysis assumes that KI would be distributed only within the EPZ. Half the residents within the EPZ are assumed to have access to their KI and to take it within the specified timeframe.

Adverse weather is typically defined as rain, ice, or snow that affects the response of the public during an emergency. Adverse weather was addressed in the movement of cohorts within the analysis using an evacuation-speed multiplier to reduce travel speed when precipitation is occurring (indicated from the meteorological data file). The evacuation speed multiplier factor was set to be 0.7, which effectively slows down the evacuating public to 70 percent of the fair-weather travel speed when precipitation exists.

The analyses of the effect of the seismic event on emergency response developed for NUREG-1935 were applied in this analysis, as the reference plant in this study was one of the plants studied in NUREG-1935. The evaluations of the potential failure of roadway infrastructure conducted for NUREG-1935 identified 12 bridges and roadway segments that could fail under

the postulated conditions. The EPZ evacuation routes identified in the emergency plan indicate that evacuees west of the river would typically evacuate in a westerly or southerly direction, and evacuees east of the river would evacuate in a northerly or easterly direction. Thus, the loss of bridges and roads would have a minimal effect on the evacuation time. The other bridges and roadways that fail in the earthquake serve sparsely populated areas where alternative roads are available. Alternate routes out of the EPZ have more than sufficient capacity to support the evacuating population.

The seismic event is assumed to cause the loss of all onsite and offsite power within the EPZ, which can affect the response timing and actions of the public. Sirens would be sounded following the GE declaration, and because the reference plant will have a fully backed up siren system in 2013, it is assumed sirens sound for this analysis. The residents within the EPZ would have felt the earthquake, which effectively serves as the initial warning; however, the loss of power would affect the number of residents receiving instructions via emergency alert system messaging. It is expected that the residents use multiple methods of communication, such as cell phones, telephones, websites (where power is available), and direct interface to communicate the emergency message.

A review of the roadway network within the EPZ indicates that there are only a few traffic signals and that most intersections are controlled with stop signs. The loss of power would cause traffic signals to default to a four-way stop mode, which is less efficient than normal signalization. It is expected that emergency response personnel would respond to these intersections and direct traffic as indicated in the site evacuation time estimate. Therefore, the loss of signalization should have a limited impact on the evacuation. It is assumed that at distances beyond 20 miles, there is no loss of power and traffic signals, and emergency alert system messaging is not impacted.

### **7.1.5 Long-Term Protective Action Modeling**

The long-term phase is the period following the seven-day emergency phase and is modeled for 50 years. The 50 year duration of the long-term phase has been chosen to provide a reasonable time period for calculating consequences from exposure for the average person. Exposure is mainly from external radiation from trace contaminants that remain after the land is decontaminated, or in lightly contaminated areas where no decontamination was required. However, internal exposures may also occur during this period, including inhalation of resuspended radionuclides and ingestion of food and water with trace contaminants. Depending on the relevant PAGs and the level of radiation, food and water below a certain limit could be considered adequately safe for ingestion, and lightly contaminated areas could be considered habitable.

A long-term cleanup policy for recovery after a severe accident does not currently exist. The actual decisions regarding how land would be recovered and populations relocated after an accident would be decided by a number of local, state, and federal jurisdictions and would most likely be based on a long-term cleanup strategy, which is currently being developed by the NRC, EPA, and other Federal agencies. Furthermore, a cleanup standard may not have an explicit dose level for cleanup. Instead, the cleanup strategy may give local jurisdictions the ability to develop localized cleanup goals after an accident, to allow for a number of factors that include sociopolitical, technical, and economic considerations. Three protective actions were modeled to occur for contaminated land during the long-term phase: interdiction, decontamination, and condemnation. As used in the MACCS2 model, interdiction and condemnation refer to the relocation of people from contaminated areas according to the habitability criterion. Interdiction

is defined in the MACCS2 model as temporary relocation during which the contamination levels are reduced by decontamination, natural weathering, and radioactive decay. Condemnation is defined in the MACCS2 model as a permanent relocation when contamination levels cannot be adequately reduced by decontamination, natural weathering, and radioactive decay.

Decontamination is modeled in a manner consistent with both NUREG-1150 and NUREG-1935. Two levels of decontamination (a decontamination factor of 3 and 15) are each assumed to take one year, but the cost of the higher decontamination factor (15) is assumed to be greater, reflecting the greater effort needed to achieve the higher level of decontamination. This study uses the values in NUREG/CR-7009 for the cost of decontamination. During the decontamination period, the land is temporarily interdicted (e.g. the population is temporarily relocated), and may be interdicted for an additional period to allow for radioactive decay and natural weathering to reduce contamination levels if needed to restore habitability. If land cannot be restored to habitability in 30 years, the MACCS2 model defines the land as condemned and residents are modeled to not return during the long-term phase. The MACCS2 models assume that decontamination will only take place if it is projected to make land habitable and if the value of the land is greater than the cost to decontaminate. If the level of contamination is too high, or if the cost of decontamination is projected to be higher than the land value, the individuals on that land are assumed to be permanently relocated. Because both the land values and the level of decontamination affect decisions on whether contaminated areas can be restored to habitability, they affect predicted long-term doses, health effects, and economic costs.

Site-specific values are used to determine long-term habitability, whereas farmability is defined to be consistent with NUREG-1150. For habitability, most states adhere to EPA guidelines that allow a dose of 2 rem in the first year and 500 mrem each year thereafter. However, consistent with the location of the reference plant, the analysis includes the State of Pennsylvania position using a habitability criterion of 500 mrem per year beginning in the first year, which is the value that is used for this study. For consistency and practicality reasons, the same standard for estimating habitability is applied to all affected areas in this study. The values used to define farmability were taken from NUREG-1150. During the year of the accident, the allowable committed dose equivalent from consumption of dairy products to an organ or tissue is 2.5 rem (7.5 rem for the thyroid), as well as an additional dose of 2.5 rem (7.5 rem for the thyroid) for all other foods. In subsequent years, the maximum allowable dose to the organ or tissue from all foods, including dairy products, is 500 mrem (1.5 rem for the thyroid). Agricultural lands projected to be contaminated to such an extent that agricultural products would exceed these levels are defined to be unfarmable, and the crops growing on these lands at the time of the accident are assumed to be disposed. No farming is allowed until the farmability criterion is satisfied.

## **7.2 Offsite Consequence Results**

Several consequence metrics have been selected to characterize the impacts resulting from a severe spent fuel pool accident. Individual risk of early and latent cancer fatality, as well as societal risk of latent cancer fatalities, are measures of the radiological health impact of the accident and consistent with NRC's safety goals (NRC, 1986). In this study, collective dose is used as a surrogate for the societal impact of latent cancer fatalities. In addition, certain metrics that would influence the values considered by the NRC in regulatory analysis and documented in NUREG/BR-0058, such as measures of offsite property damages, the number of displaced individuals (either temporarily or permanently), and the extent over which such actions may be needed, are also presented. These metrics provide a benchmark for understanding the nature

and extent of a severe spent fuel pool accident. These measures are subject to considerable uncertainty, as the details of how long-term protective actions would be carried out would have a significant effect on the actual values reported herein.

All results presented in this section are conditional upon a pool leak following a specified severe (0.71g peak ground acceleration) seismic event on the SFP at the reference plant. In the event of a pool leak following a severe seismic event, a number of potential outcomes could occur, depending upon when in the operating cycle the event occurred, the severity of the leak, and whether effective mitigation (in the form of either makeup water or pool sprays) was able to be successfully deployed prior to the beginning of the release. Staff has evaluated the likelihood of these different conditions. The relative likelihood of a seismic event during a particular operating cycle phase is simply proportional to the duration of the phase. The relative likelihood of significantly different leak rates is discussed in Section 4. Because these probabilities can be quantified with a reasonable degree of certainty, the offsite consequence results are weighted by the relative likelihood of these factors to yield an average over the different operating cycle phases and leak rates.

In contrast, the likelihood of successful deployment of 10 CFR 50.45(hh)(2) mitigation has not been quantified. NRC staff judgment is that the likelihood of successful mitigation can in many cases be high, but that it is affected by a number of factors that are difficult to quantify (see Section 5.3). Related to this, a human reliability assessment (HRA) is provided in Section 8. Although the HRA does not provide a quantitative value required to determine the overall likelihood of mitigation, it does provide significant insights into the likelihood of mitigation during this seismic event for certain damage states. To quantify the overall likelihood of successful mitigation, a PRA type analysis would be required. For this reason, the results of the study are presented as a range of mitigation effects related to successfully deployed mitigation and mitigation that is unsuccessful for 3 days.

This analysis examines the relative effects of a low-density and a high-density fuel loading configuration. Therefore, results are reported for two configurations, those being a high-density loading case with a 1x4 loading pattern and for a low-density loading case with a mixture of 1x4 and checkerboard loading patterns, as portrayed in Figure 44 through Figure 48.

In this chapter, the results for each selected metric are discussed for each loading configuration (high-density and low-density). In addition, the factors that affect the results and how those results vary with dose truncation assumptions and with distance are discussed. To the extent possible, the relationship between the results presented here and the results obtained in previous studies is discussed.

**Table 33 Overall Consequence Results**

SFP Fuel Loading	High Density (1x4)		Low Density	
Seismic Hazard Frequency <sup>1</sup> (/yr) (PGA of 0.5 to 1.0g)	1.7E-05		1.7E-05	
50.54(hh)(2) Mitigation Credited	Yes	No	Yes	No
Conditional <sup>2</sup> Probability of Release	0.036%	0.69%	0.036%	0.69%
Hydrogen Combustion Event	"Not Predicted"	"Possible"	"Not Predicted"	"Not Predicted"
Conditional <sup>3</sup> Consequences (Release Frequency-Averaged <sup>4</sup> )				
Cumulative Cs-137 Release at 72 hours (MCi)	0.26	8.8 <sup>(8)</sup>	0.19 <sup>(7)</sup>	0.11
	Measures Related to Health and Safety of Individuals			
Individual Early Fatality Risk	0	0	0	0
Individual Latent Cancer Fatality Risk <sup>5</sup> Within 10 Miles	3.4E-04	4.4E-04	3.4E-04	2.0E-04
	Measures Related to Cost Benefit Analysis			
Collective Dose (Person-Sv)	47k	350k	47k	27k
Land Interdiction <sup>6</sup> (mi <sup>2</sup> )	230	9,400	230	170
Long-term Displaced Individuals <sup>6</sup>	120k	4,100k	120k	81k
Consequences per year (Release Frequency-Weighted <sup>4</sup> )				
Release Frequency (/yr)	6.1E-09	1.2E-07	6.1E-09	1.2E-07
	Measures Related to Health and Safety of Individuals			
Individual Early Fatality Risk (/yr)	0	0	0	0
Individual Latent Cancer Fatality Risk <sup>5</sup> Within 10 Miles (/yr)	2.1E-12	5.2E-11	2.1E-12	2.4E-11
	Measures Related to Cost Benefit Analysis			
Collective Dose (Person-Sv/yr)	2.9E-04	4.1E-02	2.9E-04	3.2E-03
Land Interdiction <sup>6</sup> (mi <sup>2</sup> /yr)	1.4E-06	1.1E-03	1.4E-06	2.0E-05
Long-term Displaced Individuals <sup>6</sup> (Persons/yr)	7.1E-04	4.9E-01	7.1E-04	9.5E-03

<sup>1</sup> Seismic hazard model from USGS (Peterson et al., 2008)

<sup>2</sup> Given specified seismic-event occurs

<sup>3</sup> Given atmospheric release occurs

<sup>4</sup> Results from a release are averaged over potential variations in leak size, time since reactor shutdown, population distribution, and weather conditions (as applicable); additionally, "release frequency-weighted" results are multiplied by the release frequency.

<sup>5</sup> LNT and population-weighted (i.e., total amount of latent cancer fatalities predicted in a specified area, divided by the population that resides within that area.)

<sup>6</sup> 1st year post-accident; calculation uses a dose limit of 500 mrem per year, according to Pennsylvania Code, Title 25 § 219.51

<sup>7</sup> Mitigation can moderately increase release size (see Section 6.3); the effect is small compared to the reduction in release frequency.

<sup>8</sup> Largest releases here are associated with small leaks (although sensitivity results show large releases are possible from moderate leaks). Assuming no complications from other SFPs/reactors or shortage of available equipment/staff, Section 8 shows that there is a good chance to mitigate the small leak event.



### 7.2.1 Individual Early Fatality Risk

For all scenarios, no offsite early fatalities attributable to acute radiation exposure are predicted to occur. Due to radioactive decay, spent fuel pools tend to have significantly less shorter-lived radionuclides (e.g. I-131) than reactors. Despite this, in at least one case that was analyzed, doses close to the site did reach levels that can induce early fatalities. Therefore, the potential (although remote) for early fatalities exists. However, emergency response as treated in this study effectively prevents any early fatality risk from acute radiation exposure, at least in part because the modeled accident progression results in releases that are long compared to the implementation of emergency response in the areas of most concern.

The projections of no early fatalities in this study is lower than that reported in some previous studies of risks from spent fuel pool accidents, such as NUREG/CR-6451 and NUREG-1738, and consistent with the earlier studies documented in NUREG-1353. Tables 4.1 and 4.2 of NUREG/CR-6451 project anywhere from approximately one to one hundred early fatalities within a 500 mile radius in the event of an accident involving the full spent fuel pool, with the higher values associated with high release fractions. NUREG-1738 (Table 3.7-1 and Table 3.7-2) reported similar values, ranging from no fatalities for low Ruthenium source terms with early evacuation to up to 192 early fatalities for an accident shortly (30 days) after shutdown with high Ruthenium source terms and late evacuation. NUREG-1353 does not provide quantitative estimates of early fatality risk but states that "...there are no "early" fatalities and the risk of early injury is negligible". On balance, the scenarios analyzed here are consistent with the lower end of the reported range from previous studies, in that no early fatalities are projected to occur.

### 7.2.2 Individual Latent Cancer Fatality Risk

Despite the large releases in certain circumstances, the risk of latent cancer fatality to the average individual within 10 miles of the plant is low. When averaged over the likelihood of different event timings and leak sizes, the conditional risks within 10 miles are in the 1E-04 to 1E-03 range for cases both with and without successful 50.54(hh)(2) mitigation and for high-density and low-density cases, when using an LNT dose response model. This range does not appreciably increase even if the releases for different leak sizes or operating cycle phases are shown separately.

Individual latent cancer fatality risk is low because:

- The predicted release frequency of this event is very small
- Protective actions, especially those for long-term chronic doses, are estimated to avert significant amounts of public exposure.

Because of the nature of the event, this risk is predominantly from long-term chronic exposures. With effective long-term protective measures (e.g. temporary and permanent land interdiction), essentially no individuals receive any long-term risks greater than those associated with the dose limits for protective actions. Therefore, independent of the release magnitude of the event, these dose limits form an upper limit to individual long-term risk. In addition, emergency response is assumed to be very effective in evacuating and relocating the public. For instance, individuals within the 0-10 mile distance (representative of the plume exposure pathway EPZ) essentially only receive LCF risk if they return to low risk, habitable areas. The conditional individual LCF risks within ten miles are comparable to or lower than the projections from earlier studies of spent fuel pool accident risk. For example, NUREG-1738 reports conditional

individual latent cancer fatality risks ranging from  $8E-4$  to  $8E-2$  for a range of initiating events where large seismic events contributed the most to the overall estimate of risk. These conditional risks were driven largely by the previous estimates of ruthenium volatility and by the effectiveness of evacuation.

When the release frequency is considered, the latent cancer fatality risks from the events analyzed in this study are very small, in the  $1E-12$  to  $2E-11$  per year range, when using an LNT dose response model. For perspective, the Commission's safety goal policy related to the cancer fatality quantitative health objective (QHO) represents a  $2E-6$  per year objective for an average individual within 10 miles of the nuclear plant site (NRC, 1983). While the results of this study are scenario-specific and related to a single spent fuel pool, staff concludes that since these risks are several orders of magnitude smaller than the QHO, it is unlikely that the results here would contribute significantly to a risk that would challenge the Commission's safety goal policy (NRC, 1986).

Because the health effects that would be induced by low dose radiation are uncertain, staff performed a sensitivity analysis to understand how the risks would change if computed health risks were limited to those arising from higher doses. The upper truncation level used in this sensitivity analysis corresponds to a treatment consistent with the HPS position statement (5 rem annually and 10 rem lifetime). The second truncation level corresponds to the average annual dose to the public from medical and background radiation exposures in the United States (620 mrem annually).

Using truncation levels that do not quantify the effects of doses below the dose levels chosen here significantly reduces the estimated individual LCF risk. This is because individual LCF risk using an LNT dose response model mainly comes from doses less than those specified in protective action guidelines. Table 34 (which shows risk to residents living within ten miles, not including risk from ingestion or risk to decontamination workers) shows the use of the dose truncations that are analyzed here lowers the estimated individual LCF risk within 10 miles by several orders of magnitude. Because the dose truncations are greater than the dose limits for land interdiction, it is difficult for doses from the long-term phase to contribute to the quantified LCF risk. Therefore, emergency-phase exposures play a more significant role in the doses that exceed the truncation levels. However, the amount of early phase exposures that exceed the dose truncations is very small within 10 miles because emergency response is effective in protecting the evacuees.

A number of factors can affect quantified individual LCF risks, particularly the very small values from dose truncation results. These include potential variations of the real application of protective actions, different protective action levels, or consideration of ingestion doses. Nevertheless, the overall conclusions that with an LNT calculation, individual LCF risk is mainly from long-term chronic exposures, and that dose truncations significantly lower the estimated individual LCF risk, remain valid.

**Table 34 Dose-Response Model Results (LNT) and Dose Truncation Comparison**

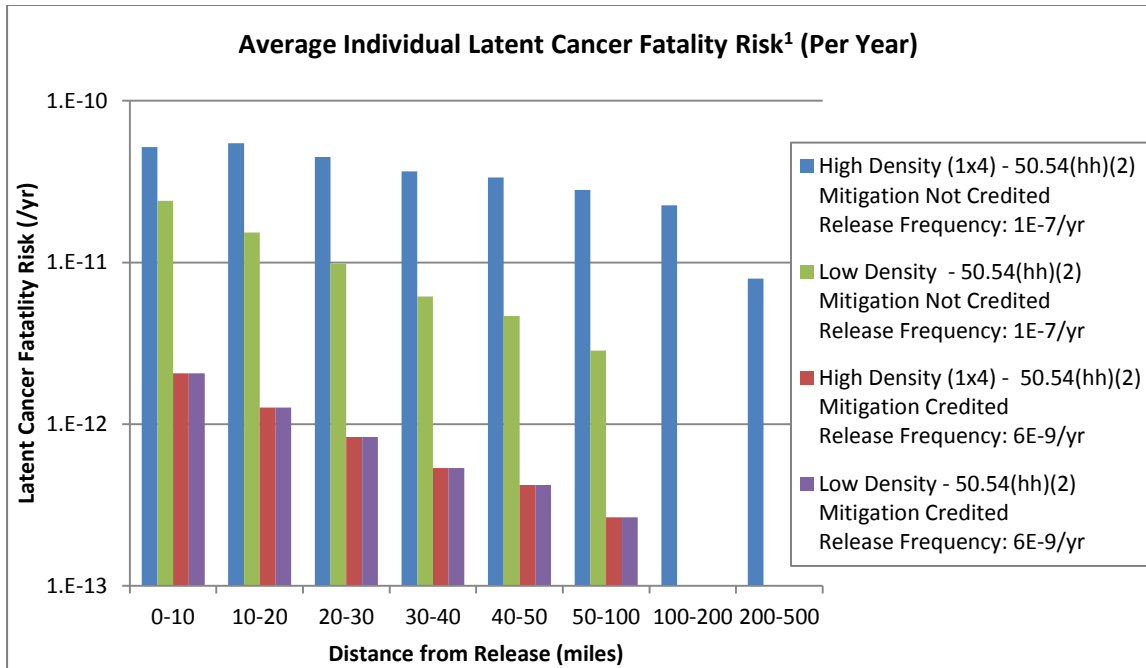
Dose-Response	High Density (1x4)		Low Density	
50.54(hh)(2) Mitigation Credited	Yes	No	Yes	No
Conditional <sup>1</sup> Individual Latent Cancer Fatality Risk Within 10 Miles (Release Frequency-Averaged <sup>2</sup> )				
Linear, No Threshold	3.4E-04	4.4E-04	3.4E-04 <sup>(3)</sup>	2.0E-04
620 mrem/yr truncation	6.1E-08	1.2E-07	6.1E-08 <sup>(3)</sup>	3.4E-08
5rem/yr or 10rem lifetime truncation	1.8E-08	1.4E-07	1.8E-08 <sup>(3)</sup>	5.6E-09
Individual Latent Cancer Fatality Risk Within 10 Miles (/yr) (Release Frequency-Weighted <sup>2</sup> )				
Linear, No Threshold	2.1E-12	5.2E-11	2.1E-12	2.4E-11
620 mrem/yr truncation	3.8E-16	1.4E-14	3.8E-16	4.0E-15
5 rem/yr or 10 rem lifetime truncation	1.1E-16	1.6E-14	1.1E-16	6.6E-16

<sup>1</sup> Conditional on a release occurring

<sup>2</sup> Results from a release are averaged over potential variations in leak size, time since reactor shutdown, population distribution, and weather conditions; additionally, "release frequency-weighted" results are multiplied by the release frequency.

<sup>3</sup> Mitigation can moderately increase release size (see Section 6.3); the effect is small compared to the reduction in release frequency.

While individual latent cancer fatality risk is very low, it decreases slowly with distance, particularly for large releases such as may occur from an accident in a high-density pool with unsuccessful mitigation for 3 days. This is because offsite release models predict significant spread of contamination to far distances, mainly because of the slow deposition of aerosols from the plume. Increasing the magnitude of the release extends the range over which a plume can travel before the radioactive inventory of the plume is significantly depleted by deposition. Furthermore, because protective actions such as land interdiction are modeled to occur wherever the model predicts that the dose limits are exceeded, most distances are held to comparably low levels of individual LCF risk regardless of the magnitude of the deposition, as was seen in the results for individual LCF risks in Table 33. This can be seen in Figure 96, which like the table, is also weighted by the release frequency.



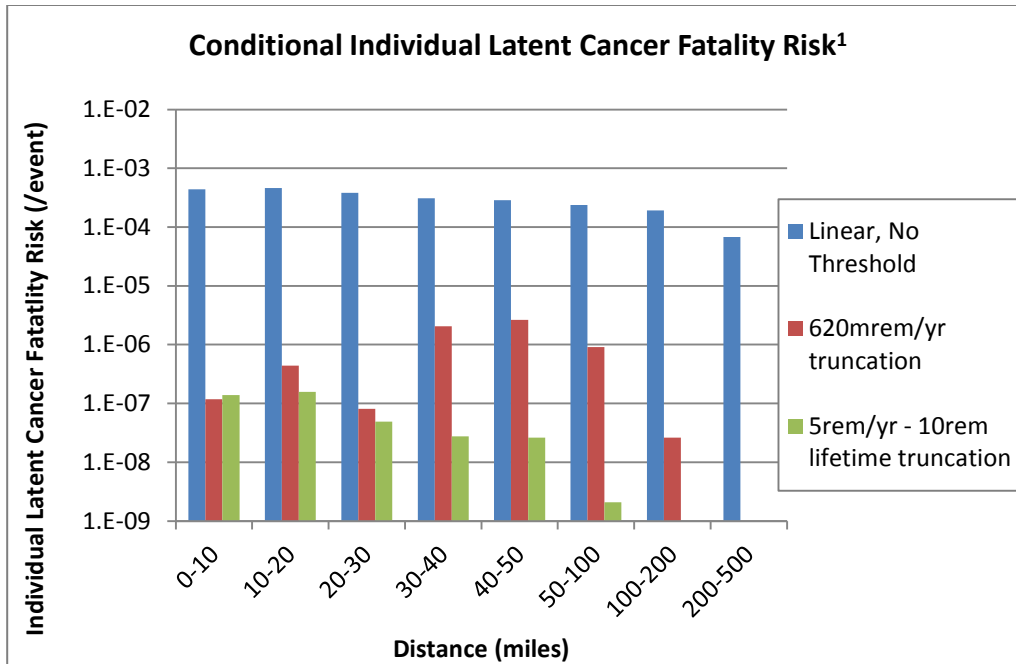
<sup>1</sup>Linear-no threshold, weather-averaged, release frequency-weighted, and population-weighted

**Figure 96 Individual Latent Cancer Fatality Risk (per year)**

The accuracy of atmospheric transport and deposition (ATD) models (e.g., the Gaussian plume segment model used in MACCS2) tend to decrease with distance, and therefore the results should be viewed with caution at longer distances. However, MACCS2 has been benchmarked against other ATD models, and the staff considers the broad conclusion remains valid—that risks would be small but drop slowly with distance in the event of large releases.

For affected areas with large populations, severe accidents can result in significant numbers of latent cancer fatalities. However, this should be weighed against the likelihood of the accident. Furthermore, because the individual doses are relatively small, this would be a small fraction of all cancer fatalities from all causes. This risk mainly comes from doses that are constrained to be less than dose limits for protective actions from an LNT dose response model; dose truncations predict significantly fewer latent cancer fatalities.

Figure 97 compares the quantified individual LCF risk for different dose truncations and for a variety of reported distance ranges for a high-density (1x4) configuration with unsuccessful mitigation for 3 days. The figure shows that dose truncation significantly lowers the quantified LCF risk. This is similar to Table 34; however this figure shows risks for a range of distances.



<sup>1</sup> High Density (1x4)—Unsuccessful Mitigation, weather-averaged, release frequency-averaged, and population-weighted

**Figure 97 Conditional Individual LCF Risk for Different Dose Truncations and Distances**

The effect of protective actions can be observed from Figure 97. For the release modeled in this scenario, the LCF risk within 10 miles is slightly less than at the 10–20 mile range. This small variation in risk with distance is because different modeled protective actions (such as evacuation, sheltering, early relocation, decontamination, temporary interdiction, and permanent condemnation) will depend on the level of contamination expected at a particular location. For example, the higher contamination levels closer to the source may result in relatively longer periods of relocation. Because no exposure to these populations would occur during this period these individuals could have lower overall doses than individuals further away under some situations. The 620 mrem annual dose truncation in particular demonstrates the effect of reduced individual LCF risk at these distances compared to longer distances. In Figure 97, the 620 mrem annual dose truncation best illustrates the effect of emergency response because this dose truncation does not quantify the significant contributions from chronic, long-term exposures.

### 7.2.3 Land Contamination

As the values in Table 33 suggest, conditional on a release (with a frequency of 1E-7 per year, or lower) occurring, the total land contamination area can be considerable. The low-frequency, large releases are significantly affected by hydrogen combustion events, which are currently predicted in some high-density loading situations without successful mitigation for 3 days, but not in other scenarios. For relatively small releases from a SFP, the extent of contaminated land could range to hundreds of square miles. For a large release, such as a release from a high-density pool without successful deployment of 50.54(hh)(2) mitigation that leads to a hydrogen combustion event, the amount of contaminated land can be two orders of magnitude higher (Table 35 partially reflects this range, although it reports average values). The levels of potential land contamination in the event of a release should be weighed against the likelihood

of the accident. When the amount of contaminated land is weighted by the annual likelihood of occurrence (as seen in Table 33), the expected impact is relatively low. In addition, only a small portion of these interdicted areas are expected to be permanently interdicted, as the level of contamination is expected to significantly decrease with time as decontamination, radioactive decay, and weathering occur.

The amount of land affected depends on the dose criterion selected. For the purposes of this study, land contamination is defined as the area impacted by protective actions, specifically either temporary or permanent land interdiction. Because of the location of the reference plant, the particular protective action level the study uses is the Pennsylvania standard for habitability (dose limit of 500 mrem each year). The study uses this measure to estimate land contamination starting in the first year after a potential severe accident. In reality, the annual dose limit for what is considered “habitable” can change when crossing a state boundary. However, for consistency and practicality reasons, the same standard for estimating land contamination area is applied to all affected areas in this study, and the measure chosen for this study is only meant to be an indicator of land contamination.

Consistent with the observations of a relatively slow decline in individual latent cancer fatality risk with distance, the results of the analysis indicate that protective actions such as temporary relocation may be needed at long distances. The table below displays an average amount of interdicted land within different distances for high- (1x4) and low-density fuel loading.

**Table 35 Average Land Interdiction\* (square miles per event)**

SFP Loading Pattern	High Density (1x4)		Low Density	
	Yes	No	Yes	No
10 CFR 50.54(hh)(2) mitigation credited				
Release Frequency (/yr)	6.1E-9	1.2E-7	6.1E-9	1.2E-7
0-50 miles	210	1,200	210**	160
0-100 miles	230	3,100	230**	170
0-500 miles	230	9,400	230**	170

\* Weather-averaged and release frequency-averaged; Dose limit of 500 mrem per year, according to Pennsylvania Code, Title 25 § 219.51

\*\* Mitigation can moderately increase release size (see Section 6.3); the effect is small compared to the reduction in release frequency.

A release in the high-density fuel loading situation without successful 50.54(hh)(2) mitigation is capable of large releases, and therefore an average release from this situation is capable of causing significantly more land contamination at longer distances than in the other situations. In contrast, releases from situations with low density fuel loading (and/or successfully deployed 50.54(hh)(2) mitigation equipment) cause a relatively smaller amount of land contamination beyond 50 miles, and none beyond 100 miles when using land interdiction as a measurement of land contamination. This is because on average, a release in these situations contaminates significantly less area. However, because of the release magnitude of any of the analyzed SFP releases, the total amount of land contamination that remains within ten miles is relatively small.

On land contamination, past results are expected to be broadly consistent with this study. However some previous studies did not report land contamination and some reported different metrics for estimating areas, so a direct comparison is not possible. NUREG/CR-6451 reports values for condemned farmland that includes hundreds of square miles within a 50-mile radius and thousands of square miles within a 500 mile radius, albeit for a full core off-load. NUREG-

1353 reports values for land contamination based on NUREG/CR-4982 that range into the hundreds of square miles, albeit largely within a 50-mile radius of the plant. These differences, as well as different choices for the land contamination criteria that can significantly affect the estimated areas, make a quantitative comparison less meaningful. However, it is clear that both this study and past studies have predicted that SFP accidents can lead to significant land contamination.

### 7.2.4 Displaced Individuals

Consistent with the results for land contamination, relatively large numbers of people may be impacted following a large release from a spent fuel pool. Displaced individuals, also known as relocated individuals, are people who are predicted to be temporarily or permanently relocated due to interdiction of contaminated land, based on the dose limit for land interdiction starting in the first year following an accident. These individuals are not necessarily the same as evacuees, who evacuate during the emergency phase (although an individual could be both of these).

Conditional on a release (with a frequency of 1E-7 per year or lower) occurring, the total number of temporarily relocated individuals could be considerable. For relatively small releases of an SFP, the number of displaced individuals could range into the hundreds of thousands. For a large release, which is predicted in some high-density loading situations early in the operating cycle without successful 50.54(hh)(2) mitigation, the number of displaced individuals can be two orders of magnitude higher. (Table 36 partially reflects this range, although it reports average values).

Also consistent with the observations related to the amount of land contamination with distance, the results of the analysis indicate that protective actions such as temporary relocation may be needed at long distances. The table below displays the average number of displaced individuals for different distances for high (1x4) and low density fuel loading.

**Table 36 Average Number of Long-term Displaced Individuals\* (per event)**

SFP Loading Pattern	High Density (1x4)		Low Density	
	Yes	No	Yes	No
10 CFR 50.54(hh)(2) mitigation credited				
Release Frequency (/yr)	6.1E-09	1.2E-07	6.1E-09	1.2E-07
0-50 miles	100k	780k	100k**	72k
0-100 miles	120k	2,000k	120k**	81k
0-500 miles	120k	4,100k	120k**	81k

\* Weather-averaged and release frequency-averaged; Dose limit of 500 mrem per year, according to Pennsylvania Code, Title 25 § 219.51

\*\* Mitigation can moderately increase release size (see Section 6.3); the effect is small compared to the reduction in release frequency.

These estimates should be weighed against the likelihood of the accident. When the number of displaced individuals is weighted by the annual likelihood of occurrence (with a frequency of 1E-7 per year or lower; as seen in Table 33), the expected impact is relatively low. An average release in the high-density fuel loading situation without successful 50.54(hh)(2) mitigation causes significantly more relocation at longer distances than in the other situations because it is capable of larger releases. In contrast, releases from situations with low density fuel loading (and/or successfully deployed 50.54(hh)(2) mitigation equipment) cause a relatively small

amount of relocation beyond 50 miles, and none beyond 100 miles because on average, a release from these scenarios contaminates significantly less area. For all situations, the number of displaced persons from the 0 to 10 mile area is relatively small because the number of people living on this area is relatively small.

### 7.3 Offsite Consequence Comparison

A goal of the study is to compare the results of the scenario-specific, high- and low- density fuel loading seismic events. To facilitate the comparison, results of different scenarios are compared to each other by dividing the results from one scenario by another scenario, for a variety of consequence metrics. The ratios of the consequence metrics are indicators of the scenario specific safety benefit between the two scenarios.

These comparisons should consider the scenario release frequency as well as conditional on a release occurring, appropriate. In the first comparison below, the high-density (1x4) fuel loading and low-density fuel loading had the same release frequency. Therefore, for this comparison, there is no additional reduction when the likelihood of occurrence is also considered.

**Table 37 Consequence<sup>1</sup> Comparison – High (1x4) Density / Low Density Loading without Successful 50.54(hh)(2) Mitigation**

SFP Fuel Loading	High Density (1x4)	Low Density	Reduction Factor (dimensionless)
Release Frequency	1.2E-07	1.2E-07	1.0
Individual Latent Cancer Fatality Risk <sup>2</sup> within 10 Miles	4.4E-04	2.0E-04	2.1
Collective Dose (Person-Sv)	350k	27k	13
Land Interdiction <sup>3</sup> (mi <sup>2</sup> )	9,400	170	56
Long-term Displaced Individuals <sup>3</sup> (Persons)	4,100k	81k	51

<sup>1</sup> Conditional on a release occurring (frequency of 1E-7 per year, or lower); results from a release are averaged over potential variations in leak size, time since reactor shutdown, population distribution, and weather conditions

<sup>2</sup> Linear-no threshold, population-weighted

<sup>3</sup> 1st year post-accident; calculation uses a dose limit of 500 mrem per year, according to Pennsylvania Code, Title 25 § 219.51

The most significant reduction factor in a low-density loading pattern is in the reduction in land interdiction and associated displaced individuals. This is because these consequences are more closely related to the size of release than the other results. In addition, a small amount of contamination can occur before land reaches the dose level for interdiction. This dose threshold effect means smaller releases more-than-proportionally reduce the amount of land interdiction.

The reduction in collective dose (and latent cancer fatalities) in a low density loading pattern is also due to the smaller release magnitude. This reduction is significant, although not as significant as the reduction in land interdiction. This is because larger releases are predicted to have considerably more temporary and permanent interdiction to protect the public. This is especially true at shorter distances, as indicated by the reduction factor for LCF risk for 0-10 miles. One significant reason a smaller release magnitude is expected in the low-density loading situations is because hydrogen combustions are currently not predicted in these situations.



The next table reports the reduction of the consequences with successful deployment of 50.54(hh)(2) mitigation equipment. Because successfully deployed mitigation can prevent fuel release, it affects the reduction factors for release frequency-weighted consequences (per year) differently than consequences conditional on a release occurring. For brevity, the consequence values are not displayed here, although can be seen in the previous section.

**Table 38 Consequence Comparison – Unsuccessful/Successful Deployment of 50.54(hh)(2) Equipment**

Fuel Loading Density	High Density (1x4)	Low Density
	Reduction Factor (dimensionless)	
Change in Release Frequency (/yr)	19	19
	Conditional <sup>1</sup> Consequences (Release Frequency-Averaged <sup>2</sup> )	
Type of Consequence	Reduction Factor (dimensionless)	
Individual Latent Cancer Fatality Risk <sup>3</sup> within 10 Miles	1.3	0.61
Collective Dose (Person-Sv)	7.4	0.59
Land Interdiction <sup>4</sup> (mi <sup>2</sup> )	40	0.72
Long-term Displaced Individuals <sup>4</sup> (Persons)	36	0.70
	Consequences per year (Release Frequency-Weighted <sup>2</sup> )	
Type of Consequence	Reduction Factor (dimensionless)	
Individual Latent Cancer Fatality Risk <sup>3</sup> within 10 Miles (/yr)	25	12
Collective Dose (Person-Sv/yr)	140	11
Land Interdiction <sup>4</sup> (mi <sup>2</sup> /yr)	780	14
Long-term Displaced Individuals <sup>4</sup> (Persons/yr)	690	13

<sup>1</sup> Conditional on a release occurring (frequency of 1E-7 per year, or lower)

<sup>2</sup> Results from a release are averaged over potential variations in leak size, time since reactor shutdown, population distribution, and weather conditions; additionally, "release frequency-weighted" results are multiplied by the release frequency.

<sup>3</sup> Linear-no threshold, population-weighted

<sup>4</sup> 1st year post-accident; calculation uses a dose limit of 500 mrem per year, according to Pennsylvania Code, Title 25 § 219.51

For both high- and low-density fuel loading, the release frequency was reduced by about a factor of 20 with successful deployment of 50.54(hh)(2) mitigation.

Conditional on a release occurring (middle portion of Table 38), successful deployment of 50.54(hh)(2) mitigation reduces all of the average consequences of the high-density fuel loading pattern, although to varying degrees. These varying degrees of consequence reductions are similar to that predicted in Table 37 for using a low-density loading pattern, although to a somewhat lesser extent. A significant portion of this reduction may be attributable to the fact that hydrogen combustions are not predicted with successful deployment of 50.54(hh)(2) equipment.

Contrary to what might be expected, 50.54(hh)(2) mitigation is predicted to slightly increase the average conditional consequences of a release from a low-density fuel loading pattern. While successful deployment of 50.54(hh)(2) equipment is usually effective at preventing releases, it is not as effective at mitigating release from the low-density fuel loading pattern when deployed in a capacity specifically to provide makeup water through injection, as sometimes assumed. In these conditions, release from a SFP can sometimes be somewhat larger with deployed mitigation. In addition, the situations for which 50.54(hh)(2) equipment prevented release for the low-density loading events were the situations with the smallest release magnitudes, which has the non-intuitive effect of increasing the average consequence of a release.

The bottom section of Table 38 shows the combined benefit of prevention and mitigation from successfully deployed 50.54(hh)(2) equipment, which combines the reduction factors of a lower release frequency with the changes in the average consequences of a release. In the high-density loading situation, the overall benefit of 50.54(hh)(2) equipment is very significant (more than a factor of 100 reduction in most of the risk metrics) if successfully deployed. For low-density loading, the deployment of the 50.54(hh)(2) equipment has a somewhat negative effect on the average conditional consequence; however, this is far outweighed by the benefit it provides in preventing release.

## 8. HUMAN RELIABILITY ANALYSIS

Consistent with the limited scope of the SFPS, a limited scope human reliability analysis (HRA) was performed, to develop initial insights into the likelihood of successful operator actions to prevent spent fuel damage for the specific seismic event and consequence scenarios studied. A full scope HRA would primarily be useful as part of a PRA analysis. A PRA would necessarily consider a much broader scope than the SFPS. Such a scope would include the likelihoods of all initiating events, the plant damage states for the two reactors and spent fuel pools, the availability of all installed or portable mitigation equipment, and the availability of on-site (and possibly off-site) personnel. Thus the limited scope HRA results presented here must be viewed from the context of their specific assumptions, including assumptions that remove likely complexities that impact operator performance.

In this context, to perform an HRA for this study, successful mitigation must be defined. For this HRA, mitigation success is defined as preventing radioactive release from the fuel rods of the Unit 3 SFP fuel (or gap release). The reference plant site has two reactor units (Unit 2 and Unit 3) in operation. The status of the Unit 2 and 3 reactors, the Unit 2 SFP, and the other plant SSCs would affect Unit 3 SFP mitigation, but successful mitigation, as defined in this analysis, is only determined by the Unit 3 SFP fuel status.

The effective SFP mitigation strategies, to prevent fuel overheating and release of radioactive material from the damaged fuel rods, are to either inject or spray water into the SFP from the refueling floor. The refueling floor on top of the reactor cavity is part of the primary containment that insulates the refueling floor from the reactor. In situations involving reactor damage with intact primary containment, access to the refueling floor is still possible. Over the refueling floor is the secondary containment which is a light-weight steel structure. During an SFP accident, the secondary containment can reduce the radioactivity released from the SFP to the environment. During refueling, the primary containment head is removed to expose the reactor cavity. The reactor vessel head is also removed for defueling and refueling. Therefore, during a refueling outage, the refueling floor is no longer insulated from the reactor. Heat and radiation generated from the reactor would directly affect the work environment on the refueling floor. In addition to the strategies of spraying water from the refueling floor to the SFP, strategies to spray water from outside of the secondary containment (e.g., by ladder fire trucks) to the secondary containment or the SFP (through containment breaches) are available. However, as these strategies are aimed at mitigating releases to outside of the secondary containment and not at preventing fuel overheating, they are not credited in this HRA study.

The SFPS ran a number of computer simulations to understand the effects of a set of factors affecting SFP fuel radioactive release after an earthquake damaged the normal SFP cooling system. The set of factors include SFP leak size, spent fuel loading pattern, OCP, mitigation deployment, mitigation flow rate, and types of mitigation (i.e., injection or spray). These simulations generated information that served as the foundation for the HRA study. Section 8.1 summarizes the SFPS results relevant to the HRA study and discusses their implications to the HRA study. Section 8.2 discusses the staffing, mitigation equipment, strategies, and procedures of the reference plant relevant to the SFP mitigation. Section 8.3 discusses the HRA study framework, scope, and approach. The conduct of an HRA is normally done in conjunction with a PRA to identify each event sequence (i.e., scenario) following an initiating event. For each event sequence, the PRA model would explicitly specify the status (i.e., success or failure) of each component, system, and human action that affects the event sequence's progression and end consequence. For this reason, the development of a PRA

model would require significant effort. For this limited scope HRA study, a detailed PRA (i.e., using event trees branched to represent various possible scenarios) was not performed. Instead, scenarios are classified based on the status of a few key SSCs (e.g., electric power availability, and the status of the Unit 3 reactor and primary containment). The Unit 3 reactor and primary containment status are included in the HRA study because of their significant effects on the Unit 3 refueling floor work environment (i.e., where the SFP mitigation strategies are performed). Table 39 summarizes the scope and assumptions applied to the HRA study. Section 8.4 summarizes the insights of this study.

**Table 39 The scope and assumptions of the HRA study**

#	Scope and assumptions	Notes
1	Success criterion: prevent radioactive release from the fuel rods of Unit 3 SFP fuel	<ul style="list-style-type: none"> <li>- Do not include strategies designed to reduce radioactivity released to the environment. The effective mitigation is to inject or spray water into the SFP.</li> <li>- The status of fuel in the Unit 2 and 3 reactors and Unit 2 SFP are not considered in the success criterion.</li> </ul>
2	Classify plant damage states as a result of the earthquake and estimate the mitigation failure probability for each plant state.	The probabilities of the plant damage states as a result of the earthquake were not estimated.
3	The installed equipment for SFP mitigation is not available. Operators have to use the 10 CFR 50.54(hh)(2) equipment for mitigation.	If the installed equipment (e.g., fire system and residual heat removal system) is available, the SFP mitigation would have a much higher success likelihood than this study's estimates.
4	The SFP mitigation uses the minimum flow rate specified in NEI 06-12 guidance for complying with 10 CFR 50.54(hh)(2).	The actual flow rate is expected to be higher than the minimum NEI recommended flow rate (i.e., 500 gpm of injection or 200 gpm of spray)
5	10 CFR 50.54(hh)(2) equipment and water sources for Unit 3 SFP mitigation is available.	Earthquake-caused damage to the 10 CFR 50.54(hh)(2) equipment is not included in the study. Further, dividing equipment to mitigate multiple reactor and SFP problems is not considered.
6	Sufficient plant staff is available to perform the Unit 3 SFP mitigation.	Staffing information is discussed but different staffing scenarios are not factored into the analysis. For multiple reactors and SFPs damaged by the hypothetical earthquake, the personnel sufficiency would be a key factor affecting mitigation success.
7	Non-plant, off-site support (e.g., off site fire trucks) are not considered.	For an SFP event, the primary function of off-site support is to keep radioactivity release within the plant site. Off-site support for preventing SFP fuel rod damage is not credited.

## 8.1 Summary of Spent Fuel Pool Study Analysis Results Relevant to Human Reliability Analysis

### 8.1.1 High Level Scenarios Classification

The SFPS concludes that the following four scenarios do not lead to gap release with a 72-hour-truncated simulation time (see Table 40 for a tabulate classification):

- (1) Boil off Scenario with No SFP Leaks. As mentioned earlier, the SFP water level in this scenario would take more than 7 days to decrease to the top of the fuel rack. Because of the long time available for response, multiple opportunities are available to prevent damage to the SFP; therefore, the human error probability (HEP) (in this study the HEP is equivalent to mitigation failure probability) is negligible.
- (2) Mitigated Scenario for Small Leaks. No fuel damage occurred when the makeup water was injected into the SFP at the time specified by the SFPS. The SFPS suggests that, as long as the spent fuel is covered with water, SFP failure would not occur. Therefore, the available time for operators to respond is longer than the SFPS injection time in some scenarios. For these scenarios, the HEPs were calculated.
- (3) Unmitigated Scenario in Late Phases (i.e., OCPs 4 and 5). These scenarios have low decay heat. Even when relying only on natural air circulation, heat convection and radiation, and other natural means of heat transfer, overheating of the spent fuel can be prevented. For these scenarios, the HEPs were not calculated.
- (4) Mitigated Moderate Leak Scenarios in OCP2, OCP3, OCP4, and OCP5. When SFP water is drained to the top of fuel rack, the radiation level is considered too high to deploy SFP mitigation strategies on the refuel floor (discussed in section 8.2.3). In OCP2, the SFP water takes almost 6 hours to drain to the top of the fuel rack but only about 2.5 hours in OCP3. The HEPs were calculated for OCPs 2 and 3. The HEPs for OCPs 4 and 5 were not calculated because SFP decay heat is insufficient to cause fuel damage, as noted above.

The SFPS shows that the SFP status is stable in the four scenario classes listed above following termination of the computer simulations at 72 hours after the initiating event. This result implies that, for the unmitigated scenarios, if spent fuel damage does not occur within the first 72 hours, spent fuel damage would not occur afterward because the decrease in decay heat and long time available for response.

**Table 40 The SFPS Simulation Results.**

	No Leak (90%)	Small Leak (5%)	Moderate Leak (5%)
OCP 1 (0.9%)			~ 0.05%
OCP 2 (2.4%)		~0.8%	
OCP 3 (5.0%)			
OCP 4 (25.7%)			
OCP 5 (66%)		~ 99.2%	

- OCP: Operating Cycle Phase
- Percentages above are percent of the time for corresponding condition.

Table 40 provides an overview for performing an HRA as follows:

- The green cells represent that either the HEP is negligible or mitigation does not affect the end consequence. For the SFP no leakage scenario, the SFPS calculated that SFP water would take more than 7 days to boil to the top of the fuel rack. Because of the long time available for mitigation, the HEP is negligible. For the scenario in which the earthquake occurs during OCPs 4 and 5, the SFP fuel decay heat is insufficient to cause a gap release event even without the provision of SFP makeup flow; therefore, mitigation does not affect the end consequence. These two scenario classes (i.e., no leakage and the occurrence of the earthquake during OCPs 4 and 5) are colored as green cells and total about 99.2 percent of the conditional probability. An HRA is not performed for the scenarios in the green cells.
- The OCP 1 moderate leakage scenario (i.e., the red cell with a ~0.05% conditional probability in Table 40) would result in a gap release regardless of whether mitigation has taken place because the current NEI guidance for complying with 10 CFR 50.54(hh)(2) is insufficient (providing at least 500 gpm of injection flow or 200 gpm of spray flow<sup>40</sup>). The flow rates are provided by two flow paths using fire hoses. Significantly increasing the mitigation flow rate requires setting up additional fire hoses to provide additional flow paths. Because the procedures do not provide instructions on when additional flow paths should be established, this study concludes that no additional flow path other than the two procedure-instructed flow paths will be used for SFP mitigation. Therefore, gap release would occur in the OCP1 moderate leak scenarios. This is not because the mitigation flow cannot be deployed in time, but is because the flow rate is insufficient for the assumed OCP 1 decay heat load as determined by SFPS section 6.3.2.<sup>41</sup>
- The yellow colored cells represent conditions where gap release can be prevented if the minimum NEI recommended SFP makeup flow (i.e., 500 gpm of injection or 200 gpm of spray) is deployed in time. This HRA focuses on these scenarios for which mitigation would prevent gap release.

### 8.1.2 Key Factors Affecting Available Time for Mitigation

The SFPS divides the reference plant operation cycle into five OCPs. OCPs 1 and 2 occur during refueling in which the SFP and reactor cavity are hydraulically connected. Because the reactor cavity and SFP are located within the same reactor building and they are hydraulically connected, a reactor problem would affect the refueling floor work environment in which the effective mitigative actions to prevent SFP fuel damage are performed. OCPs 3, 4, and 5 occur during at-power operations in which the SFP and reactor cavity are hydraulically disconnected.

<sup>40</sup> NEI 06-12, "B.5.b Phase 2 and 3 Submittal Guideline," issued December 2006 (ADAMS Accession Nos. ML070090060 and ML070080351) recommends minimum of 500 gpm of injection and 200 gpm of spray for implementation of the requirements in 10 CFR 50.54(hh)(2).

<sup>41</sup> In comparison with OCP 1, moderate leakage, and mitigated scenarios, the OCP 2 scenario has the same makeup type (i.e., injection), makeup flow rate, and makeup deployment time. However, gap release did not occur in the OCP 2 scenario because the hottest 88 assemblies for OCP 1 at approximately 4 days have a decay heat of 1,927 kilowatts (kW) or 65 percent of the whole SFP (2,951 kW), whereas the hottest assemblies for OCP 2 at 13 days have a decay heat of 1,143 kW or 32 percent of the whole SFP (3,567 kW).

This HRA assumes different rates of spent fuel decay heat for each OCP, which in turn affects the required mitigation flow and, to some degree, the available time for mitigation necessary to prevent SFP damage.

The SFPS groups the SFP damage caused by the earthquake into three classes: (1) no leakage, (2) small leakage, and (3) moderate leakage with a corresponding conditional probability of 90 percent, 5 percent, and 5 percent, respectively. The small leakage scenario is represented by 40 small tears in the stainless steel liner at the backup bar locations. The small cracks create an initial leakage rate of about 250 gpm. The leakage flow rate depends on the SFP water level. As the SFP water level decreases, the leakage rate reduces. The moderate leakage is represented by a long crack with a combination of the stainless steel SFP liner tear and a through-wall concrete crack at the bottom of the SFP wall. Section 4.1.5 of this report discusses the SFPS damage states in detail. The moderate leak creates an initial leakage rate of about 1,900 gpm.

The HRA assumes that the SFP leak rate affects the available time necessary for mitigation because, when the SFP fuel is not covered by water, the radiation level at the locations in which mitigative equipment is stored and mitigative actions are performed is assumed to be too high for performance of the mitigative actions in this study. Thus, the SFP leak rate directly affects the SFP fuel uncover time. Table 41 shows the time to SFP fuel uncover in the various scenarios.

**Table 41 Approximate Time of Fuel Uncovery**

<b>Time</b>	<b>No Leak</b>	<b>Small Leak</b>	<b>Moderate Leak</b>
OCPs 1 and 2	> 7 days	40 hours	6 hours
OCPs 3, 4, and 5	> 7 days	19 hours	2.5 hours

Figure 98 shows the approximate dose rate contours in the refueling area at the time of defueling when the SFP water level is at the top of the fuel rack. The radiation at the mitigation equipment storage location ranges from 3–30 rem per hour and the radiation level at the locations of the spray nozzles for SFP makeup is in the range of 10 to 300 rem per hour. Working at this radiation level could cause emergency responders who perform mitigation actions to receive doses greater than those in EPA’s PAGs (EPA, 1992). This radiation map is the basis for specifying that the SFP makeup must be deployed before the SFP water level reaches the top of the fuel rack in order to credit mitigation success.

In addition to radiation, high temperature on the refueling floor is another factor that affects mitigation success. In this study, 140 °F (60 °C) is used as the temperature threshold. The refueling floor reaches 140 °F before the SFP water level is drained to the top of fuel rack only in the OCP 1 and 2 small leak scenarios. In these scenarios, the reactor head is open. Boiling in the reactor cavity significantly increases the temperature on the refueling floor. Figure 99 shows the time history of the refueling floor temperature of the OCP 1 small leak scenarios. The temperature reaches 140 °F in about 13.5 hours. Figure 100 shows the time history of the refueling floor temperature of the OCP 2 small leak scenarios. The temperature reaches 140 °F in about 26 hours. Because of the long available response time and steep temperature increase at the time of 140 °F reached, changing the temperature threshold to a higher temperature does not affect the HRA results.

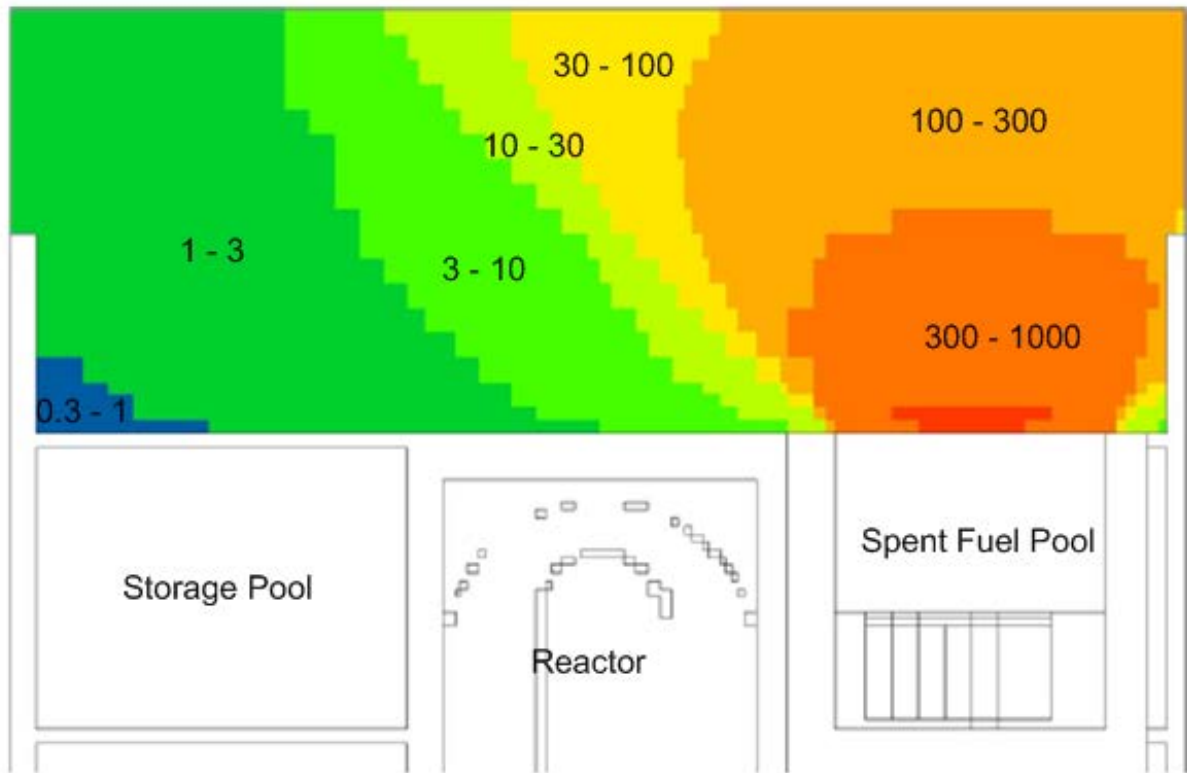
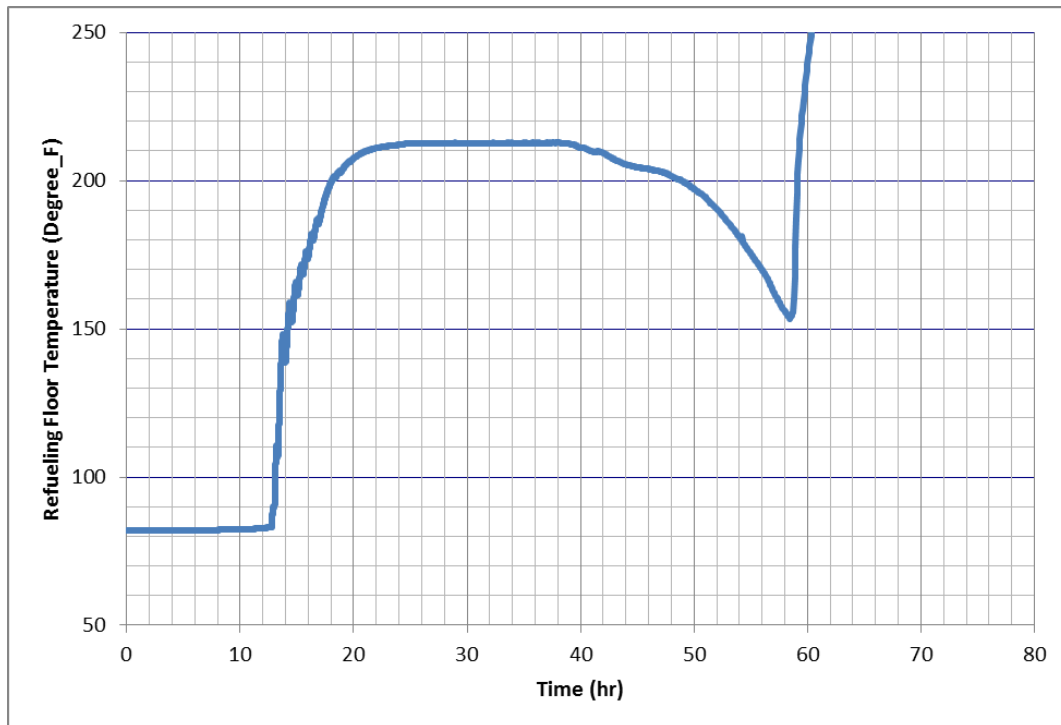
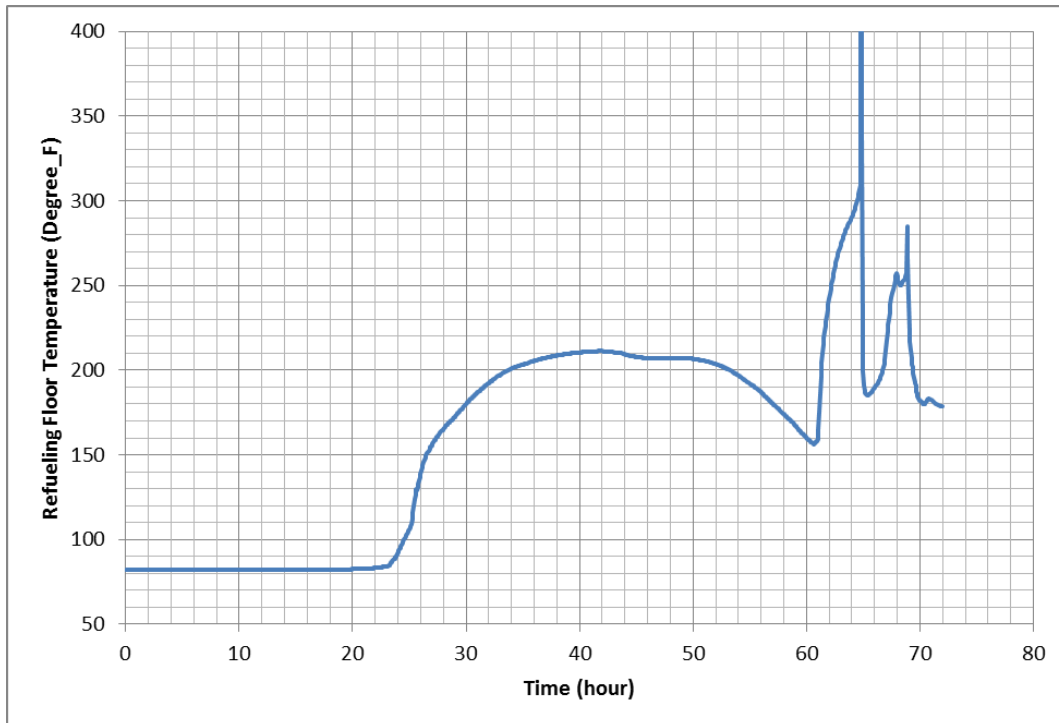


Figure 98 Approximate dose rate of elevation contours, water at the top of fuel hardware, around the time of defueling (rem per hour).





**Figure 99 The refueling floor temperature of OCP1 small leak scenarios.**



**Figure 100 The refueling floor temperature of OCP 2 small leak scenarios.**

In summary, successful deployment of the mitigation strategy has to be done before the earliest of either the SFP water reaching the top of the fuel rack or the reactor building atmosphere reaching 140 °F. Table 42 shows these available times for the scenarios of interest.

**Table 42 The available time\***

	Small Leak (hr)	Moderate Leak (hr)
OCP 1	13.5**	6***
OCP 2	26**	6***
OCP 3	19***	2.5***

\* Assume Unit 3 reactor is not damaged

\*\* Due to refueling floor temperature reaching 140°F

\*\*\* Due to SFP water level draining to the top of fuel rack

## 8.2 Staffing, Mitigation Equipment, Strategies, and Procedures

### 8.2.1 Staffing, Procedures, Training, and Response Time

#### Staffing

This HRA assumes that sufficient plant staff is available for Unit 3 SFP mitigation. In the situation that the hypothetical earthquake causes damage to multiple SSCs, additional events (e.g., fire), and personnel injury, the assumption may not be applicable to some scenarios.

The reference plant uses a combined main control room for its two reactor units. Consistent with NEI 12-01, the on-shift personnel are assumed to be limited to the minimum complement allowed by the site emergency plan. This represents a staffing level during backshift, weekend or holiday. The staffing level of the reference plant, Units 2 and 3, during the backshift, weekend, and holiday includes the following:

- Main Control Room
  - One Shift Manager (Licensed Senior Reactor Operator (SRO)). The shift manager oversees the control room activities and assesses the emergency action level.
  - One Shift Technical Advisor (Licensed SRO). The shift technical advisor performs independent plant status assessment.
  - Two Control Room Supervisors (Licensed SROs). The control room supervisors implement procedures as a team with the reactor operators (ROs).
  - Two Licensed ROs. The ROs perform control board actions according to the control room supervisors' instructions and answer emergency phone calls.
  - Two Assistant (or Spare) Licensed ROs. The assistant operators perform the same functions as the ROs.
- On Site
  - One Field Supervisor (Licensed SRO). The field supervisor oversees onsite activities.
  - Nine Auxiliary Operators. The auxiliary operators will report to the main control room after the earthquake to obtain the master keys for the assigned tasks. Five of the nine auxiliary operators are on the fire brigade.
  - Additional Staff. Additional staffing comprises health physicists, chemical staff, maintenance personnel, and security staff onsite who can support mitigation (e.g., health physicists will provide refueling floor radiation information). However, these personnel are not expected to directly perform SFP mitigative actions.

The above summary describes a typical staffing level during backshift, weekend or holiday of the reference plant instead of the minimum staffing requirement, or during a normal weekday or refueling. If the earthquake occurs during normal working hours or if either Unit 2 or 3 is in a refueling outage, the staffing level would be significantly higher.

To augment staffing, except calling for the off-site plant staff (e.g., to mobilize emergency response facilities), the reference plant can also call for the nearby Delta-Cardiff Volunteer Fire Company to assist in tasks such as SFP mitigation, fire mitigation, and treatment of injured personnel. The fire company could send engines, tankers, a ladder fire truck, an air unit, an ambulance and personnel to the reference plant site. Based upon the above assumptions, this analysis assumes that there is sufficient staff for Unit 3 SFP mitigation. No detailed analysis is performed on the staffing situation for all scenarios.

### Procedures and Operator Initial Responses

In the hypothetical earthquake that causes a station blackout (SBO), the general response is that the control room supervisors work with the ROs to implement the emergency response procedures. In this case, the entry conditions of the following three procedures are met:

- (1) SE-11, "Loss of Offsite Power"
- (2) SE-5, "Earthquake"
- (3) TSG-4.1, "Operational Contingency Guideline"

The control room supervisors work with ROs to implement the above three procedures in parallel. The immediate objectives are to ensure that the reactor is properly tripped and ensure sufficient electricity, equipment, and water to maintain reactor cooling. Because a high-priority task in an SBO scenario is the provision of emergency electric power, the control room supervisors would send two auxiliary operators to inspect the emergency diesel generators and would direct one assistant (or auxiliary) operator to implement SE-11 to connect the dedicated power supply from the Conowingo Hydroelectric Generating Station (Conowingo) to the reference plant. If the earthquake has not affected Conowingo, connecting its supply power to the reference plant would take about 1 hour during normal conditions. The other auxiliary operators will be tasked with performing a plant walkdown and SFP inspection in accordance with SE-5.

### Training

Training related to the implementation of TSG-4.1 and 10 CFR 50.54(hh)(2) includes the following:

- annual training in emergency response organization mobilization and implementation of the TSG-4.1 and TSG-4.2, "Extreme Damage Mitigation Guidelines for Loss of Large Area of the Plant," procedures and the related requirements in 10 CFR 50.54(hh)(2)
- biannual training on security threat responses
- initial training on procedures and equipment related to 10 CFR 50.54(hh)(2)

### Response Time

NEI 06-12, Revision 2, "B.5.b Phase 2 & 3 Submittal Guidance," states that plants should be able to deploy a flexible means of providing SFP makeup (i.e., either 500 gpm of injection or 200 gpm of spray per unit) within 2 hours from the time in which plant personnel diagnose that external SFP makeup is required. This HRA study uses the 2-hour deployment time as the action time for deploying mitigation. The total mitigation time is the sum of delay time, diagnosis time, and action time (discussed in Section 8.3.2.2).

The analysis in Volume 1 of NUREG/CR-7110, "State-of-the-Art Reactor Consequence Analyses Project," estimates that, given the hypothetical earthquake event that causes SBO but with dc power, the technical support center (TSC) is assumed operational within 2.25 hours after the earthquake. The NEI 12-01 guideline assumes the following site accessibility: (1) no site access within the first 6 hours; (2) limited site access between 6 to 24 hours; and (3) improved site access after 24 hours. The assumptions apply to a large-scale external event that occurs that results in: (1) all on-site units affected; (2) extended loss of AC power, and (3) impeded access to the reactor buildings. The emergency response facilities most relevant to responding to the hypothetical earthquake are the operational support center (OSC), which is an onsite assembly area separate from the control room, and the TSC to which licensee operations support personnel report in an emergency. NUREG/CR-7110 does not provide an estimated time in which the OSC will be operational. Therefore, for the purposes of this study the TSC assumption of 2.25-hours is also used for the OSC when neither Unit 2 nor Unit 3 is in a refueling outage. The OSC provides additional man power to mitigate plant damage, but this additional staff is not considered in this HRA study.

## 8.2.2 Mitigation Equipment

This HRA study assumes that portable mitigation equipment is available but the installed equipment is not available for Unit 3 SFP mitigation. The portable equipment includes the two portable diesel pumps discussed in this section. The installed equipment includes the fire system and residual heat removal system. If the earthquake causes damage to multiple reactors and SFPs that consequently requires mitigation equipment, there may not be sufficient portable equipment for the Unit 3 SFP mitigation. For the purposes of this study, portable mitigation equipment was assumed to be available.

The reference plant relies on the following onsite equipment and systems for SFP makeup:

- Fire System: One motor-driven fire pump and one diesel-driven fire pump are necessary to pressurize the fire header. The diesel-driven fire pump is designed to operate for 6.4 hours at full load. Making up the diesel fuel requires the use of a temporary 120-volt ac power source to restore a fuel oil transfer pump to deliver fuel for the diesel-driven fire pump. In situations in which both fire pumps are lost and cannot be repaired within 1 hour, the reference plant will contact the York County 911 center for a fire engine to pressurize the onsite fire header. If the reference plant cannot obtain offsite support and if the situation allows, the reference plant can use one of the two portable diesel pumps to pressurize the fire header.

The two fire pumps are housed in a seismic Class I tornado-resistant structure. Therefore, the diesel-driven fire pump is assumed functional after the earthquake. However, the underground fire pipes may be damaged by the earthquake. Depending on the damage, the fire system may still be available by isolating the damaged section or sections or by using a fire hose in place of the fire main. The fire system is the preferred water source for the most effective mitigation strategies necessary to prevent

spent fuel gap release. If the fire system is not available, the Conowingo pond or torus storage tank is the alternative water source.

- Diesel-Driven Portable (DDP) Pump. The diesel-driven portable pump has the capability of delivering 600 gpm of water. A trailer stationed near the pump stores all piping, connectors, and spray nozzle. A dedicated pickup truck will be used to tow the pump and trailer to the specified location for operation. With a full tank, which is the normal condition, the pump can continue to run for more than 12 hours. The DDP pump has a 4" discharge connection. To deliver the flow rate of 500 gpm of injection or 250 gpm of spray the plant staff uses a wye adapter to connect the 4" discharge to two 2.5" hoses. The reference plant demonstrated that the combination flow rate met the 500 gpm of injection and 200 gpm of spray requirements.
- Diesel-Driven High-Capacity Portable (DDHCP) Pump. The diesel-driven high-capacity portable pump has the capability of delivering 1,300 gpm of water. The DDHCP pump has two 4" discharge connections. To deliver the NEI recommended flow rate, the plant staff uses a wye adapter to connect a 4" discharge to two 2.5" hoses. Four 2.5" discharging hoses would be needed to reach the pump maximum discharge capacity. The TSG-4.1 instructs the plant staff to connect two 2.5" hoses to a 4" discharge connection for SFP makeup. The reference plant demonstrated that the combination flow rate of using two hoses exceeds the 500 gpm of injection and 200 gpm of spray requirements. Like the diesel-driven portable pump, dedicated pickup trucks will be used to tow the portable pump to the designated location for operation.

The HRA team identified the three systems listed above during a site visit to the reference plant in July 2012. The HRA team was aware that the reference plant planned to purchase more equipment to address Order EA-12-49 mitigating strategies; however, this HRA study does not credit the additional equipment.

The reference plant stores much of its mitigation equipment at grade level. Section 2.4.3.5 of reference plant's FSAR discusses the effect of a simultaneous failure of the upstream Holtwood dam on the site. The FSAR indicates that the upstream Holtwood dam failure would not increase the level of the Conowingo pond such that it would exceed the grade level at the site. Therefore, a simultaneous Holtwood dam failure is not assumed to affect the availability of mitigation equipment.

### **8.2.3 Mitigation Strategies**

NEI 06-12 discusses implementation strategies for SFP makeup and spray. The mitigation strategy described in NEI-06-12 provides that it should be implemented within two hours after the decision of deploying the mitigation strategy. This NEI guidance defines the actions that should be taken in situations in which normal procedures or command and control structures are not available. The notes in the parentheses below include items not considered applicable to the accident scenarios for the SFPS. The assumptions in the guidance include the NEI-06-12:

- An immediate threat warning does not occur.
- Access to the control room is lost (not expected in SFPS scenarios).

- Equipment or supplies normally located in the control room or in the building that houses the control room are lost (not expected in SFPS scenarios).
- Access to the building that contains the control room is lost (not expected in SFPS scenarios).
- All personnel normally in the control room are lost (not expected in SFPS scenarios).
- All ac and dc power required for operation of plant systems is lost (i.e., both class 1E and non-class 1E sources).
- Only minimum site staffing levels are available (i.e., weekend/backshift). Note: the minimum staff mentioned in the NEI guidance is not the minimum staff requirements. Instead, it refers to the normal staffing level during weekend or backshift. This assumption does not apply when either Unit 2 or Unit 3 is in refueling outage.
- Other onsite control rooms and personnel in separated building are unaffected. (Personnel injury is likely to occur given the hypothetical earthquake.)
- Operations personnel who are not normally located in the control building are available for implementation of extensive damage mitigation guidelines.
- Nonlicensed personnel, typically an auxiliary operator, can perform the mitigative actions.
- The level of training on implementing procedures and guidance is consistent with actions under severe accident management guidelines and is consistent with utility commitments made under B.5.b Phase 1.
- Before the event, the plant systems are in a normal configuration with the reactor at 100-percent power. (This SFP safety analysis includes refueling outages (i.e., OCPs 1 and 2).)

The above items that are noted in parentheses as not expected in the SFPS scenarios apply to TSG-4.2. TSG-4.2 may not apply to the SFPS scenarios. Instead, TSG-4.1 is the most applicable procedure for the SFPS scenarios. The sections below discuss the SFP mitigation strategies in accordance with TSG-4.1.

#### Internal Makeup

This strategy connects two fire hoses to the two existing fire system standpipes on the refueling floor to provide a minimum of 500-gpm total injection flow to the SFP. The fire system must be pressurized to implement this strategy. To implement this strategy, the operators need to remove the existing 1.5-in reducer from the two fire standpipes, connect two 2.5-in fire hoses to the two standpipes, and route the two fire hoses to the SFP. Operators can deliver makeup flow by fastening the hose to the SFP side for direct injection into the SFP. Operators can also deliver makeup flow by connecting the two fire hoses to the two spray nozzles to spray water into the SFP. This strategy will deliver a total spray flow of more than 200 gpm. All equipment mentioned is available on the refueling floor. This strategy assumes that the refueling floor is accessible for local makeup.

### External Makeup and Spray

This strategy uses any of the two portable diesel pumps (Section 8.2.2) to inject or spray water into the SFP. This strategy requires the plant staff to (1) tow the portable diesel pump to the desired location at grade level, (2) lay two approximately 200-ft fire hoses that are connected by two sections from the refueling floor through a stairwell to the grade level (about 100 ft in elevation difference) to connect the hoses to the charging output of the portable pump, (3) connect the hose end on the refueling floor to an spray nozzle, and (4) connect the portable pump's suction to a fire hydrant. The hoses for connecting the pump discharge to the spray nozzles are stored on the refueling floor. Each spray nozzle can be adjusted for spray or to obtain full flow (i.e., injection).

The external makeup and spray mitigation strategy uses the fire water system as the default water source to the portable diesel pumps. Under situations in which the fire water system is not available, the reference plant's procedure SO-37L.1.a, "Diesel Driven Portable and Diesel Driven High Capacity Portable Pump Startup and Shutdown," identifies additional water sources, including the inner pond, discharge pond, and Conowingo pond. In the event of a seismically induced failure of the Conowingo pond, the loss-of-pond procedure provides cooling water management strategies. In addition, the reference plant Assignment Report No. 01001590 identifies the candidate water sources, including high-pressure service water, fire water, residual heat removal water, condensate transfer water, and cross connections to the opposing unit's spent fuel water supply. Detailed step-by-step instructions for using water from the alternative water sources are not available. However, this HRA study credits the use of the alternative water sources in the situations when the fire water is not available because of the similarity of using water from these sources to drafting fire water.

### External Local Spray or Scrub

This strategy uses any of the following three procedures, individually or in combination, to provide spent fuel cooling or secondary containment spray to scrub potential radionuclides released from the SFP primary or secondary containment structures:

- (1) Use the portable diesel pump to provide water to the two spray nozzles on the refueling floor to spray water into the SFP. This strategy requires operators to lay out fire hoses from the refueling floor to grade level, as described in the section above entitled, "External Makeup and Spray."
- (2) Use the portable diesel pump to provide water to one or two of the two spray nozzles located on the turbine building roof to spray water to the secondary containment or the refueling floor through building breaches. This strategy requires operators to lay out hoses from the turbine building roof to grade level to connect the portable pump and the spray nozzle.
- (3) Use a ladder truck to spray water into the SFP area through building breaches from the steel structure surrounding the SFP floor. This strategy requires the use of an offsite fire company's 100-ft ladder fire truck. Exelon Generation Company, LLC (owner of the reference plant), has a letter of agreement with nearby Delta-Cardiff Volunteer Fire Company. Upon dispatch and without additional complexity, the fire truck could arrive at the reference plant within 30 minutes (Assignment Report No. 01001590). The Delta-Cardiff Volunteer Fire Company possesses two fire trucks from Seagrave Fire

Apparatus, LLC, either one of which can perform the portable diesel pump function. Other nearby fire companies could support the reference plant mitigative efforts.

Items (2) and (3) above are useful primarily to mitigate the release of radioactivity off-site, but are not effective in preventing radioactive release from the SFP fuel rods. Because the mitigation success of this HRA study is to prevent radioactive release from the SFP fuel rods, items (2) and (3) are not credited in this HRA study. TSG-4.1 requires the plant to use the external local spray or scrub strategy after it has attempted the internal makeup and external makeup and spray strategies (as discussed earlier). For consistency with the NEI guidance, the reference plant uses the flowchart shown in Figure 101 as general guidance for deployment of SFP mitigation strategies.

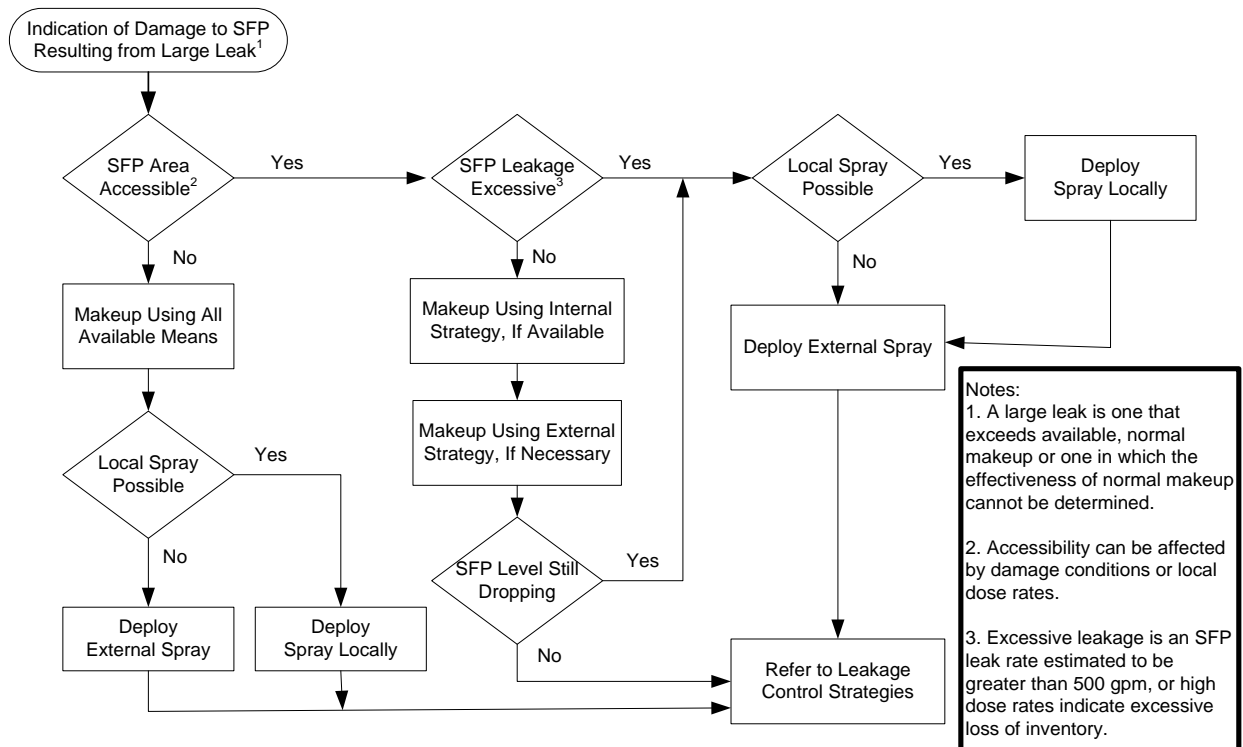
#### Makeup with Residual Heat Removal Pump from the Torus

This strategy requires that electrical power is available for a residual heat removal pump to pump torus water into the SFP at a flow rate of 10,000 gpm. This flow rate is much larger than the maximum moderate leakage flow rate (i.e., approximately 1,900 gpm). In an SBO scenario, this strategy is not available because power is not available for the residual heat removal pumps. This HRA study assumes this strategy is not available.

#### Leakage Control

The reference plant has a list of stocked materials that could help to reduce the leakage flow rate, including steel plates, plywood, bag stopper, sealants, ropes, and rubber matting. Certain materials would require a crane for moving (e.g., 5/8-in by 4-ft by 4-ft steel plates). Based on its emphasis on the initiation of makeup strategies and the 72-hr scope of the analysis, the study did not consider repair options.



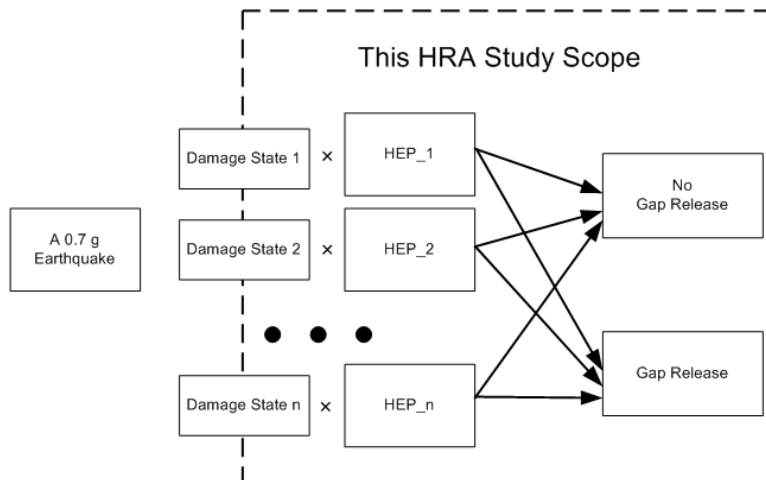


**Figure 101 Generalized guidance for SFP makeup and spray decisions**

### 8.3 Study Framework, Scope, and Approach

#### 8.3.1 Study Framework and Scope

Preventing gap release of the Unit 3 SFP fuel is the success criterion defined in this HRA study. Because human performance is sensitive to the extent of earthquake damage to the plant, the study identifies a set of plant damage states and estimates an HEP for each damage state. Identification of the damage state is based on the status of a few key SSCs that include electric power availability, reactor status, and fire system availability. Figure 102 illustrates the framework and scope of this HRA study. The large rectangle with dashed lines shown in Figure 102 represents the scope of this HRA study. Each box within the dashed lines represents a probability. The partial enclosure of the damage state signifies that the scope of this HRA study only identifies the plant damage states; it does not estimate the probabilities of the damage states. Therefore, the gap release (and no gap release) probabilities could not be estimated, and the HEPs were computed to only provide initial general insights.



**Figure 102 The study framework**

### 8.3.2 Approach to Human Error Probability Estimates

#### 8.3.2.1 A Two-Phased Approach to HEP Estimates

This HRA study used a two-phase approach to estimate mitigation failure probabilities or human error probabilities (HEPs). Phase 1 estimates HEPs for mitigating the reference plant SFP leak. These estimates consider the status of the electric power, reactor and primary containment, and fire system of Unit 3, the Unit 3 OCP, and Unit 3 SFP leakage rate. These are the dominant factors that affect mitigation of a single SFP leak. In Phase 2, other damage to the site that affects mitigation is discussed. Phase 2 involves situations that combine reactor and SFP problems or multiple unit problems caused by the same earthquake. The four discrete steps listed below represent the HEP estimation process used in this analysis. The four sections that follow discuss these steps in detail.

- (1) Identify the time required for deployment of SFP makeup.
- (2) Identify the damage states and corresponding available time.
- (3) Estimate the HEP of each damage state.
- (4) Identify additional feasibility considerations.

#### 8.3.2.2 Step 1—Identify the Time Required

In this study, the total time necessary for deployment of the SFP makeup is the sum of the following three time segments:

- (1) Delay Time: In an earthquake-induced SBO scenario, the control room operator's primary focus is on reactor safety. Although the SFP trouble alarm is triggered soon after the earthquake, a time delay occurs for starting a diagnosis process to investigate an SFP problem. The cue for starting to investigate the SFP is the earthquake procedure SE-5. Step 9 of the procedure instructs the operators to check the SFP, SFP cooling system, and fuel floor blowout panels. Based on an interview with PBAPS staff, the delay time ranges between 30 minutes and 1 hour. This study uses 45 minutes for the SBO scenarios, 30 minutes for LOOP scenarios, and 60 minutes for SBO without dc power scenarios because, based on crew interviews, the control room supervisor would, at a minimum, simultaneously implement SE-11 and SE-5. When less electricity is

available for maintaining reactor safety margin, the operators would put more effort into restoring electricity (i.e., SE-11). As a result, less time is spent on SE-5, which consequently would delay implementation of Step 9 in SE-5 to send auxiliary operators to check the SFP status.

- (2) Diagnosis Time: Diagnosis time is the time between when auxiliary operators are deployed to inspect the SFP and when they report SFP leakage back to the control room operators. Based on the leakage rate (both small leakage and moderate leakage) and leakage locations (i.e., the SFP bottom at the elevation of a few inches above the 195-ft floor), detecting SFP leakage is not a challenging task. Based on the same interview with PBAPS staff and a plant walkdown of the path that the auxiliary operators would normally take to inspect the SFP, the diagnosis time was determined to be 15 minutes.
- (3) Action Time: The 2-hr implementation expectation in NEI 06-12 is used for deployment of the portable diesel pump to provide SFP makeup. The HRA uses the 2 hours as the action time at which the fire system is available because TSG-4.1 instructs the staff on how to use the fire system as the water source. When the fire system is not available, using water from the alternative water sources would require additional time. An additional 1 hour of action time is necessary when the fire system is not available.

Table 43 and Table 44 summarize the time estimates based on the above discussion. Table 43 shows the mitigation time estimates in the scenarios for which fire water is sufficient for mitigation. Table 44 adds 1 hour of action time to Table 43 to account for the effect of unavailable or insufficient fire water. In Table 43 and Table 44, note that the total time difference between the LOOP scenarios and SBO without dc scenarios is only 30 minutes. However, the conditional reactor core damage probability in these two scenarios would be significantly different. Further, the conditional reactor core damage probability in these two scenarios would have a significant difference. That difference directly affects the refueling floor accessibility and, in turn, the mitigation success probability. This HRA study assesses HEPs for the SBO and SBO without dc scenarios with and without reactor core damage separately.

**Table 43 Estimates of the Time Required for the Operator to Deploy SFP Makeup If Fire Water Is Available**

	Delay Time	Diagnosis Time	Action Time	Total Time Required
LOOP	30 minutes	15 minutes	2 hours	2 hours 45 minutes
SBO	45 minutes	15 minutes	2 hours	3 hours
SBO without dc	60 minutes	15 minutes	2 hours	3 hours 15 minutes

**Table 44 Estimates of the Time Required for the Operator to Deploy SFP Makeup If Fire Water Is Not Available or If It Cannot Deliver Sufficient Flow**

	Delay Time	Diagnosis Time	Action Time	Total Time Required
LOOP	30 minutes	15 minutes	3 hours	3 hours 45 minutes
SBO	45 minutes	15 minutes	3 hours	4 hours
SBO without dc	60 minutes	15 minutes	3 hours	4 hours 15 minutes

### 8.3.2.3 Step 2—Identify the Damage States and Available Time

The key factors that affect the likelihood of successful mitigation of the Unit 3 SFP include SFP leakage size; OCP; and the status of the electric power, reactor and primary containment, and fire system of Unit 3. These factors characterize the damage states (as shown in Table 47). SFP leakage size and whether the SFP and the reactor cavity are hydraulically connected (i.e., during refueling and nonrefueling) largely determine available time. As discussed earlier, the available time is determined by the shorter time of either the SFP water reaching the top of the fuel rack or the refueling floor reaching 140°F. Table 45 shows the time required and time available of the damage states of interest assuming the Unit 3 reactor is not damaged.

**Table 45 Estimates of time required and time available for mitigation**

		Small Leak		Moderate Leak	
		Time Required(hr)	Time Available(hr)	Time Required(hr)	Time Available(hr)
OCP 1	LOOP	2.75(3.75)	13.5	2.75(3.75)	6
	SBO	3.0(4.0)		3.0(4.0)	
	SBO w/o DC	3.25(4.25)		3.25(4.25)	
OCP 2	LOOP	2.75(3.75)	26	2.75(3.75)	6
	SBO	3.0(4.0)		3.0(4.0)	
	SBO w/o DC	3.25(4.25)		3.25(4.25)	
OCP 3	LOOP	2.75(3.75)	19	2.75(3.75)	2.5
	SBO	3.0(4.0)		3.0(4.0)	
	SBO w/o DC	3.25(4.25)		3.25(4.25)	

\*The numbers outside the parentheses are the time required when the fire system is available. The numbers inside the parentheses are the time required when the fire system is not available.

\*\*These values assume that the Unit 3 reactor is not damaged and the staff uses the portable diesel driven pumps for SFP mitigation

### 8.3.2.4 Step 3—Estimate Basic HEPs of a Single Unit Event

This step estimates the basic HEPs for each damage state based on the following assumptions and practices:

- The required mitigative equipment stored outside of the reference plant, Unit 3, and water sources are available. Step 4 considers equipment and water unavailability and other factors.

- The plant staff is available for performing the mitigation activities.
- The earthquake damaged much of the nonsafety piping and equipment but the workplace is accessible (with additional difficulties from normal situations).
- The purpose of including some situations in the HRA (e.g., core damage within the specified available time) is to explicitly identify the key factors that affect human performance. Estimating the likelihood of the occurrence of these situations is outside the scope of this HRA study. Estimating the likelihood of each situation would require a PRA.

The main considerations necessary for assessing HEPs are based on the time margin and workload that affect staffing availability. Electric power availability strongly affects workload. The power availability is classified into: (1) LOOP only, (2) SBO, and (3) SBO without dc. The three classes of power availability impose significant differences in operator workload that, in turn, affect personnel availability to perform all required tasks. The flow diagram in Figure 103 shows the HEP estimation procedure, which is based on NUREG-6883 “The SPAR-H Human Reliability Analysis Method” issued in 2005, supplemented with the NRC staff’s expert judgment.

SPAR-H’s low power and shut down diagnosis worksheets classify time margin effects into five classes as shown in Table 46.

**Table 46 Time margin effects on human error probability in the SPAR-H HRA method for cognitive activities in low power /shutdown operations**

Class	HEP or HEP Multiplier	Note
Insufficient time	HEP = 1.0	Less than 2/3 of normally time required
Barely adequate time	HEP multiplier = 10	~2/3 of normally time required
Nominal time	HEP multiplier = 1	About the normally time required
Extra time	HEP multiplier = 0.1	Equal to or greater than 5 times of normal time required
Expansive time	HEP multiplier = 0.01	Equal to or greater than 50 times of normal time required

The SPAR-H’s action worksheets use slightly different time scales to adjust the HEP. The adjusting factor 1 in Figure 103 represent time margin effects on HEP based on SPAR-H’s classification. The adjusting factor 2 in Figure 103 represents the performance shaping factors of “complexity” and “ergonomics/human machine interface” of SPAR-H. Table 47 shows the HEP calculation results. Note that OCP1 moderate leak scenarios are likely to have gap release because the NEI recommended minimum mitigation flow rates are insufficient to prevent gap release. This is not reflected in Table 47 because this is not considered as a human error in a typical HRA application.

Table 47 shows that fire system availability in general does not have significant effects on human error probability. Table 48 summarizes the qualitative results of the HRA with respect to the likelihood of gap release in various plant states with the assumption of no reactor core damage. Two plant states have an HEP of 1.0: moderate leak in OCP1 and moderate leak in OCP3. In OCP1 moderate leak scenarios, the high likelihood is because the NEI recommended

minimum mitigation flow rates are insufficient to prevent gap release. The high likelihood is not shown in Table 47 because the failure is considered as a design issue rather than a human error from a conventional HRA perspective. In OCP3 moderate leak scenarios, the high likelihood is because of the short time available for response (i.e., about 2.5 hours).

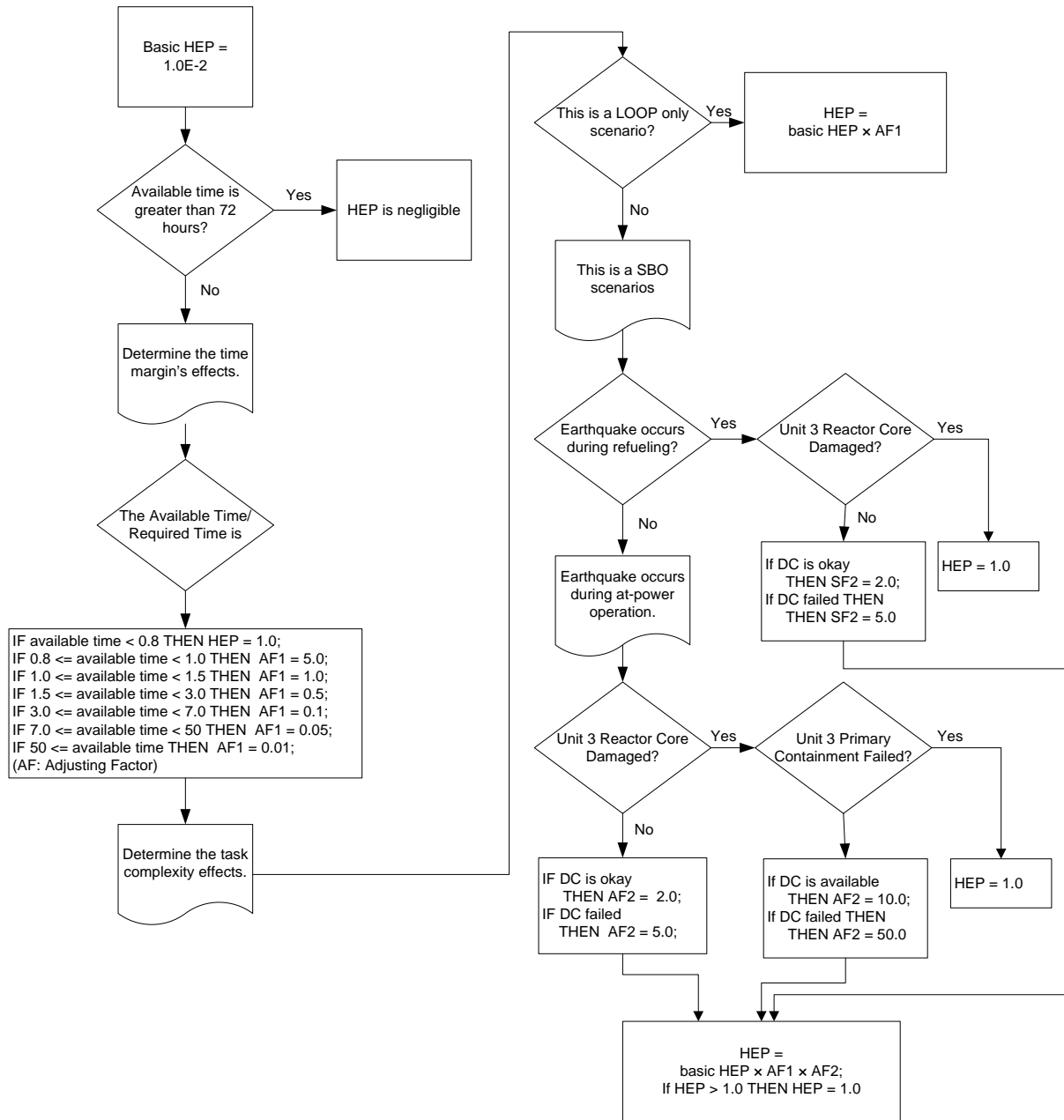


Figure 103 Flow chart for estimating HEPs for a single reactor unit event

**Table 47 Human error probability estimates of a single unit event**

			Small Leak	Moderate Leak
OCP 1	LOOP*		0.001 (0.001)	0.003 (0.003)
	SBO	No CD	0.006 (0.006)	0.002 (0.002)
		CD	1 (1)	1 (1)
	SBO w/o DC	No CD	0.015 (0.015)	0.005 (0.005)
		CD	1 (1)	1 (1)
OCP 2	LOOP*	No CD	0.003 (0.003)	0.0005 (0.001)
	SBO	No CD	0.006 (0.006)	0.001 (0.002)
		CD	1 (1)	1 (1)
	SBO w/o DC	No CD	0.015 (0.015)	0.0025 (0.005)
		CD	1 (1)	1 (1)
OCP 3	LOOP*	No CD	0.01 (0.1)	0.001 (0.001)
	SBO	No CD	0.2 (1)	0.002 (0.002)
		CD; CTM intact	1 (1)	0.05 (0.05)
		CD, CTM breach	1 (1)	1 (1)
	SBO w/o DC	No CD	0.5 (1)	0.005 (0.005)
		CD; CTM intact	1 (1)	0.05 (0.05)
		CD, CTM breach	1 (1)	1 (1)

\*Assume no reactor core damage (CD)

\*\*The numbers outside the parentheses are the HEPs when the fire system is available. The numbers inside the parentheses are the HEPs when the fire system is not available

**Table 48 The likelihood of gap release\***

	Small Leak (5%)**	Moderate Leak (5%)**
OCP 1 (0.9%)**	Low <sup>1</sup>	High <sup>2</sup>
OCP 2 (2.4%)**	Low <sup>1</sup>	Low <sup>3</sup>
OCP 3 (5.0%)**	Low <sup>1</sup>	High <sup>4</sup>

\*Assumes only one SFP damaged without concurrent reactor core damage

\*\*The probabilities are conditional probabilities given that the studied earthquake occurs

<sup>1</sup>The available time for response is long. The SFP fuel is submerged if SFP makeup is deployed in time.

<sup>2</sup>The NEI recommended minimum mitigation flow rate is insufficient to prevent gap release.

<sup>3</sup>The NEI recommended minimum mitigation flow rate is sufficient to prevent gap release.

<sup>4</sup>The available time for response is short so that the SFP makeup will likely not be deployed in time to prevent gap release.

### 8.3.2.5 Step 4—Additional Feasibility Considerations

This final step (i.e., Step 4) identifies situations that occur outside of the reference plant, Unit 3, that would have adverse effects on Unit 3 SFP mitigation. These effects are not considered in Step 3. These additional considerations include the following:

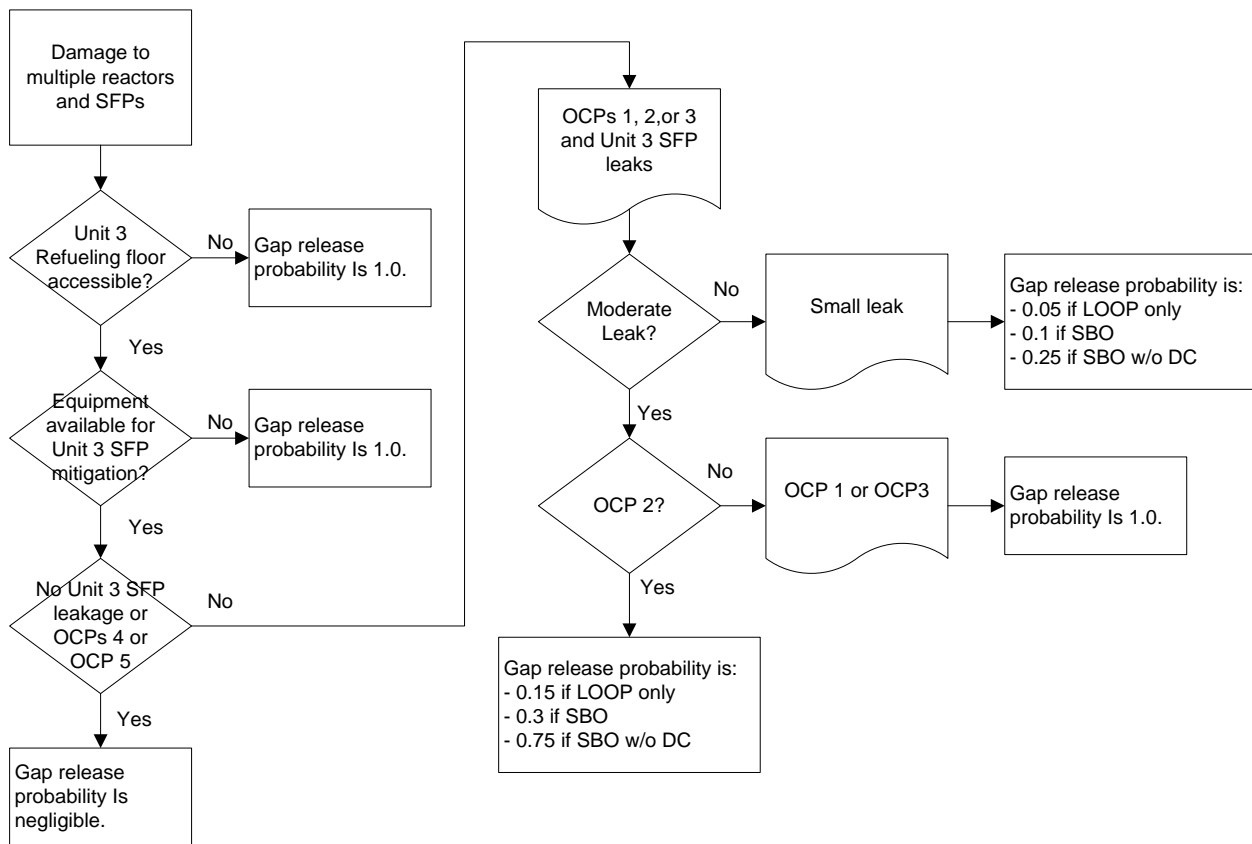
- Equipment demand cannot be met: When the earthquake causes extensive damage to the reactors and SFPs of Unit 2 and Unit 3 and the normal reactor and SFP cool down mechanisms are not available, the two portable pumps may not be available for Unit 3 SFP makeup given the multiple demands. The DDHCP pump has two 4" discharge connections, and the DDP pump has one 4" discharge connection. In combination, the two portable diesel pumps can deliver three times the NEI recommended minimum mitigation flow rate. The operators have to decide how to use the limited equipment for multiple problems for the reference plant's two reactors and two SFPs. The decision will strongly depend on the situation.
- Damage to the mitigation equipment (e.g., the DDHCP pump and DDP pump) and support equipment (e.g., pump accessories and the designated truck to tow the pumps) would reduce the available equipment or delay mitigation.
- Simultaneous large or multiple fire events that demand more plant staff personnel than those available.
- Structural damage causes plant personnel injury that could result in less than adequate personnel available for SFP mitigation.
- Unit 3 Refueling floor is inaccessible for reasons such as Unit 3 reactor damage causing high radiation in the access path.

The cells in Table 48 with low gap release likelihood can be split into two groups:

- Greater than 13 hours for all small leak scenarios
- About 6 hours for OCP 2 moderate leak scenarios



In either situation, sufficiency of plant response personnel is likely not an issue because of the long available time of the small leakage scenarios and in refueling outage of the OCP 2 scenarios. Though not accomplished through a full scope PRA, this HRA attempted to account for the complexity of handling multiple reactors and SFP damage events. As such, an adjusting factor of 50 (based on the SPAR-H's performance shaping factors of "high complexity" and "low experience/training") was applied to Table 47. The results are summarized in Figure 104 and Table 49.



**Figure 104 The gap release probability assessments given damage to multiple reactors and SFPs.**

Table 49 shows three levels of likelihood of having radioactive release from the Unit 3 SFP fuel rods. Three colored coded regions are discussed below:

- **Green Cells**  
Two sub groups in the green coded cells: (1) the “no leak” scenarios have long available time (greater than 7 days) for response. The mitigation failure probability is determined to be negligible; and (2) The OCP4 and OCP5 have low decay heat. Even without mitigation, radioactive release is not expected.
- **Yellow Cells:**  
For the small leak scenarios, the available time ranges from more than 13 hours to more than 1 day. Given the long time available, time is not a critical factor affecting mitigation success. The mitigation failure probability is estimated to range from one failure out of twenty to one failure out of four. For the OCP2 moderate leak scenarios, the time

available is 6 hours. This increases the mitigation failure probability compared to the small leak scenarios. The mitigation failure probabilities for OCP 2 moderate leak scenario range from one failure out of twenty to three failures out of four.

- Red Cells:  
Two red cells are in Table 49. The OCP1 moderate leak scenario is red because the 500 gpm of injection or 200 gpm spray is insufficient to prevent fuel overheating. The OCP3 moderate leak scenario has only a short time available (2.5 hours), and mitigation is not expected to be deployed in time.

**Table 49 Scenario Specific Human Error Probability Estimates\*.**

	No Leak (90%)	Small Leak (5%)	Moderate Leak (5%)
OCP 1 (0.9%)	Negligible	- 0.05 if LOOP only - 0.1 if SBO - 0.25 if SBO w/o DC	1.0**
OCP 2 (2.4%)			- 0.15 if LOOP only - 0.3 if SBO - 0.75 if SBO w/o DC
OCP 3 (5.0%)			1.0***
OCP 4 and OCP 5 (91.7%)	Inconsequential		

- OCP: Operating Cycle Phase

- Percentages above are the percent of the time for the corresponding condition.

\* Assume mitigating equipment is available for Unit 3 SFP, and Unit 3 reactor status does not deny access to the Unit 3 refueling floor.

\*\*The NEI recommended minimum mitigation flow rate is not sufficient to prevent gap release. The procedure (i.e., TSG-4.1) does not instruct operators to establish an additional SFP makeup flow path to significantly increase the SFP makeup flow rate to be greater than the minimum flow rate recommended by NEI. The HEP is set to 1.0 to indicate that gap release would occur.

\*\*\*Primarily due to short time available for response (i.e., ~ 2.5 hours). OCPs 1 and 2 (i.e., during refueling) have the reactor cavity and SFP hydraulically connected, which provides more time than OCP3.

## 8.4 Discussion and Summary

This SFP HRA study identifies a set of plant damage states and calculates the corresponding HEPs; however, it does not calculate the conditional probabilities of the damage states. The following information summarizes the human performance insights:

- The HEPs of the SFP no leakage scenarios are negligible because of the long time available for response. The scenarios in OCPs 4 and 5 would not lead to gap release of the SFP fuel because of the low spent fuel decay heat. These two groups of scenarios share 99.2 percent of the probability (i.e., 0.992). In other words, given the 0.5–1.0g earthquake, the SFPS estimates minimum 99.2-percent conditional probability that a gap release would not occur.
- 500 gpm of injection is not sufficient to prevent gap release in the OCP1 moderate leak scenarios, as determined in the SFPS. The SFPS did not perform sensitivity calculations to determine the NEI recommended flow rates (either injection or spray) to prevent gap release in this case. Therefore, this HRA study assumes that the plant staff would need to connect more than the proceduralized two hoses to the portable diesel pump and use more than two spray nozzles to provide sufficient cooling. Because TSG-4.1 only provides instructions on establishing two hoses and two spray nozzles, the lack of procedures and insufficient equipment (i.e., hoses and spray nozzles) are assumed to

cause the mitigation to fail in the OCP1 moderate leak scenarios. Even though the reference plant flow rates are greater than the NEI recommended minimum flow rate, sensitivity calculations on the actual flow rate from the spray nozzle would be needed for a more detailed assessment.

- The available time for SFP mitigation is determined by the shorter time of either the SFP water draining to the top of the fuel or the refueling floor reaching 140°F. In the OCP 1 and 2 small leakage scenarios, the refueling floor reaches 140°F earlier than the time necessary for the SFP water to drain to the top of the fuel rack thus causing refueling floor temperature to become the limiting factor for determining HEPs
- The two spray nozzles (as illustrated in TSG-4.1) for SFP makeup are set up in high radiation areas. Delivering the same amount of flow from a low-dose area (e.g., near the wall next to the storage pool) would significantly increase the available time because using the time necessary for the SFP water level to reach the top of the fuel rack as a criterion is based on the radiation level at the locations of the spray nozzles, as specified in TSG-4.1. Moving the spray nozzles setup locations to a lower dose area would significantly increase the mitigation success probabilities for moderate leak scenarios for which the time necessary for SFP water to drain to the top of the fuel rack is the limiting factor.
- The fire system availability (from earthquake-induced fire piping rupture) affects OCP 3 moderate leakage scenarios but not small leak scenarios because the small leak scenarios have at least 13 hours for mitigation deployment. Instructions on how to quickly determine whether the fire system can deliver sufficient flow for mitigation may improve the probability of successful mitigation.

The success criterion of this HRA study is to prevent a radioactive release from the Unit 3 SFP fuel rods. The mitigation strategies that emphasize keeping the radioactivity released from the fuel rods on site are not within this HRA scope. Deploying these strategies could mitigate radioactive releases to the environment.

The HEP results shown in Table 49 are based on the assumptions that mitigation equipment is available, there is no combination of Unit 3 reactor core damage and primary containment failure that causes inaccessibility of the refueling floor, and there is sufficient staff to deploy for the Unit 3 SFP mitigation. If the earthquake damages multiple reactors and SFPs some of the above assumptions may not apply. An analysis of these issues would require the performance of a PRA and associated HRA.

## 9. CONSIDERATION OF UNCERTAINTY

This section catalogues a set of sensitivity analyses to better understand the potential effect of certain assumptions on the results of this study. The sensitivity analyses include those for analyzing additional plant states (e.g., 1x8 pattern in a high-density loading configuration) and for analyzing parameter/model uncertainties (e.g., hydrogen combustion ignition). The assumptions analyzed were chosen from the list of key assumptions compiled in Section 2, based on their perceived importance and project constraints.

### 9.1 Sensitivity to Hydrogen Combustion (MELCOR)

A sensitivity calculation was performed to examine the response of the SFP to the hydrogen combustion ignition criterion. This calculation involved reducing the hydrogen concentration from 10 percent to 7 percent given the inherent uncertainties in this parameter discussed before. The case that showed the strongest sensitivity to this parameter is the unmitigated high-density, moderate leak size scenario from OCP 2. The base case reactor building concentration of gases in Figure 105 shows that, by the time the hydrogen concentration exceeds the ignition criterion of 10 percent, the oxygen concentration is below the 5-percent limit and no hydrogen combustion is predicted. However, at about 18 hours, both the hydrogen and oxygen concentrations are above 7 percent, which can support a hydrogen combustion. Figure 106 shows the mole fraction of gases for this sensitivity case. At about 18 hours, the hydrogen combustion consumes the hydrogen in the building as evidenced by the rapid decrease in the hydrogen concentration and is accompanied by a sudden increase in the oxygen concentration as the failure of the reactor building causes the outside air to enter. Following the air ingress, the clad oxidation power significantly increases (compare the base case in Figure 107 with the sensitivity case in Figure 108). The higher oxidation power leads to higher clad temperatures<sup>42</sup> (Figure 109 and Figure 110) and additional release of fission products from the fuel and release to the environment (Figure 111 and Figure 112). The cesium release fraction of 50 percent for this sensitivity is much higher than the base case of 1.6 percent (see Table 27), and it is comparable to the release fraction of 49 percent for the uniform pattern (see Table 50).

---

<sup>42</sup> The failure of the fuel rods leads to formation of debris that continues to release fission products.

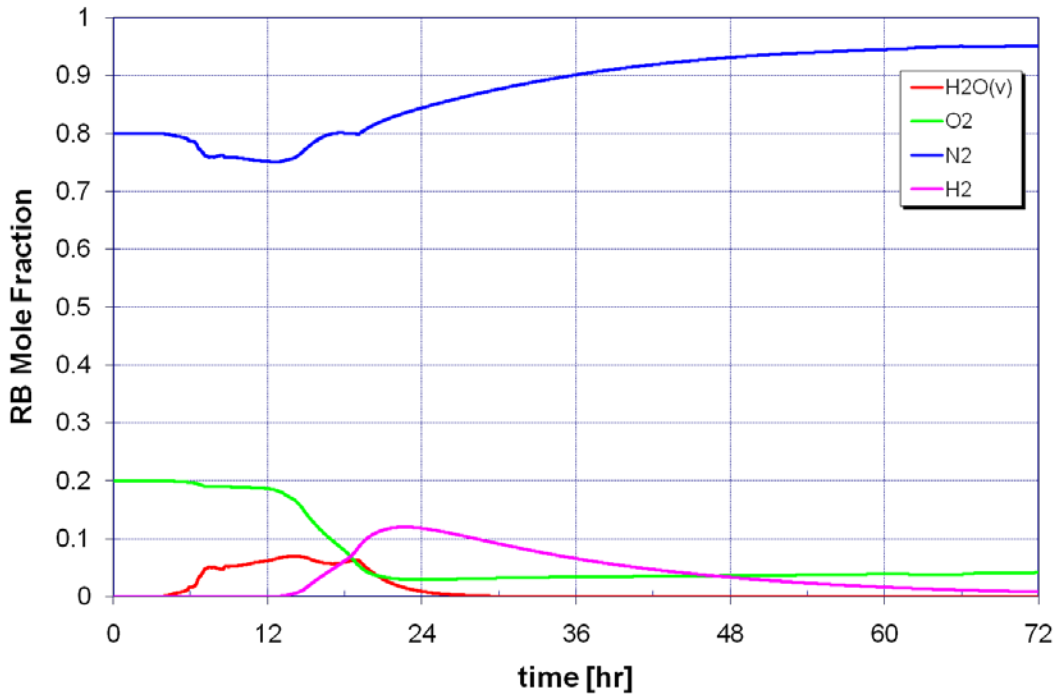


Figure 105 Reactor building mole fraction for unmitigated high-density moderate leak (OCP2)

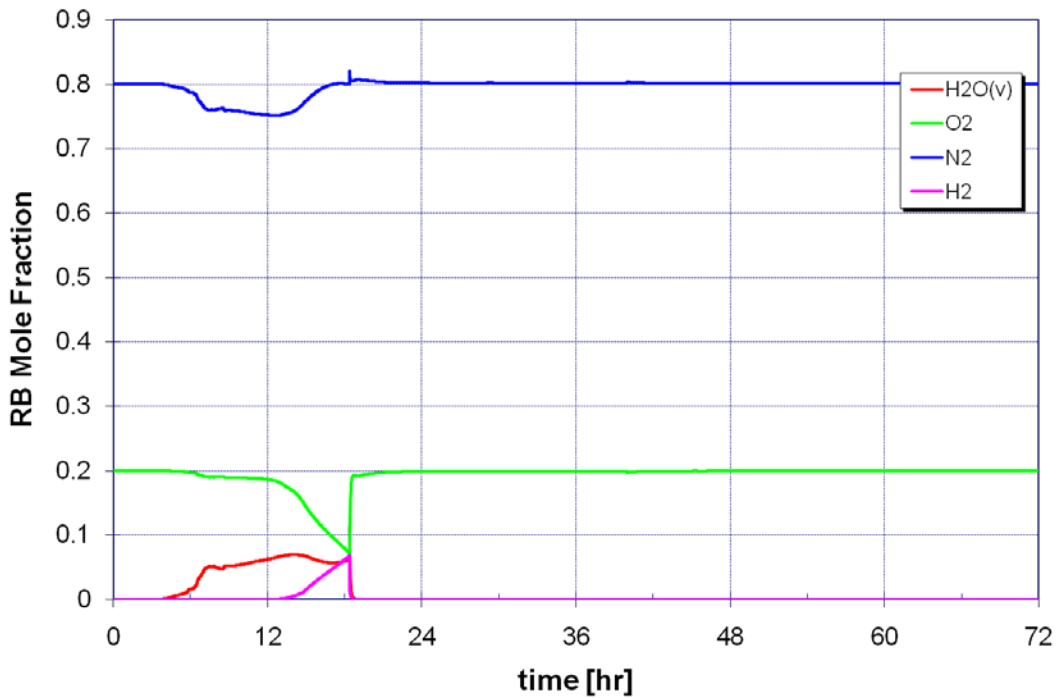
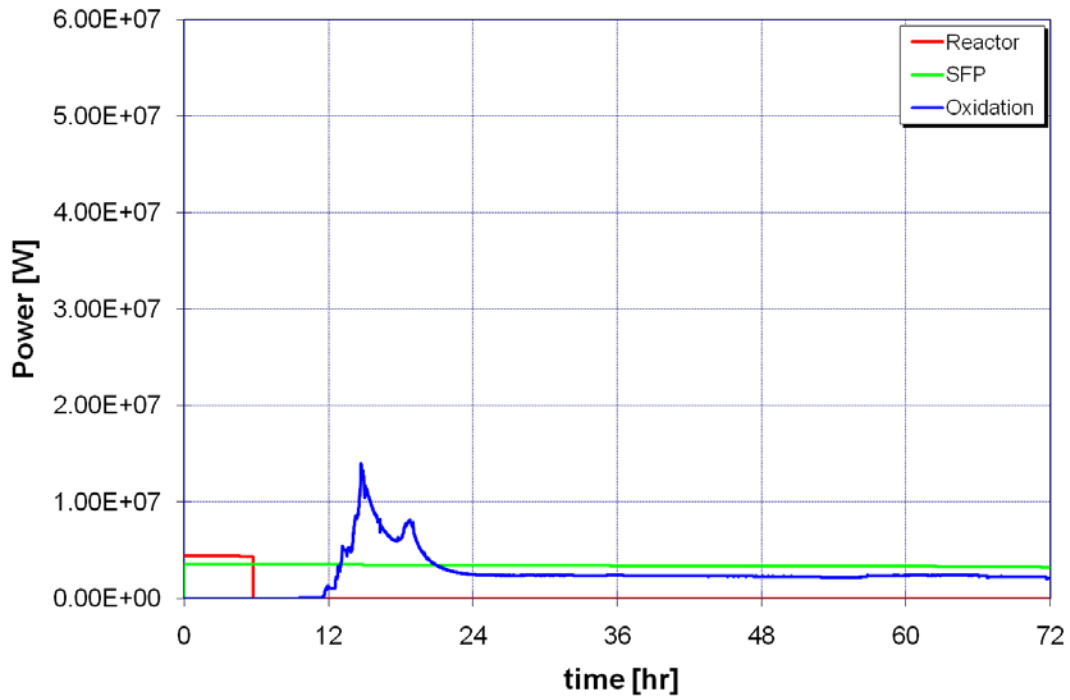
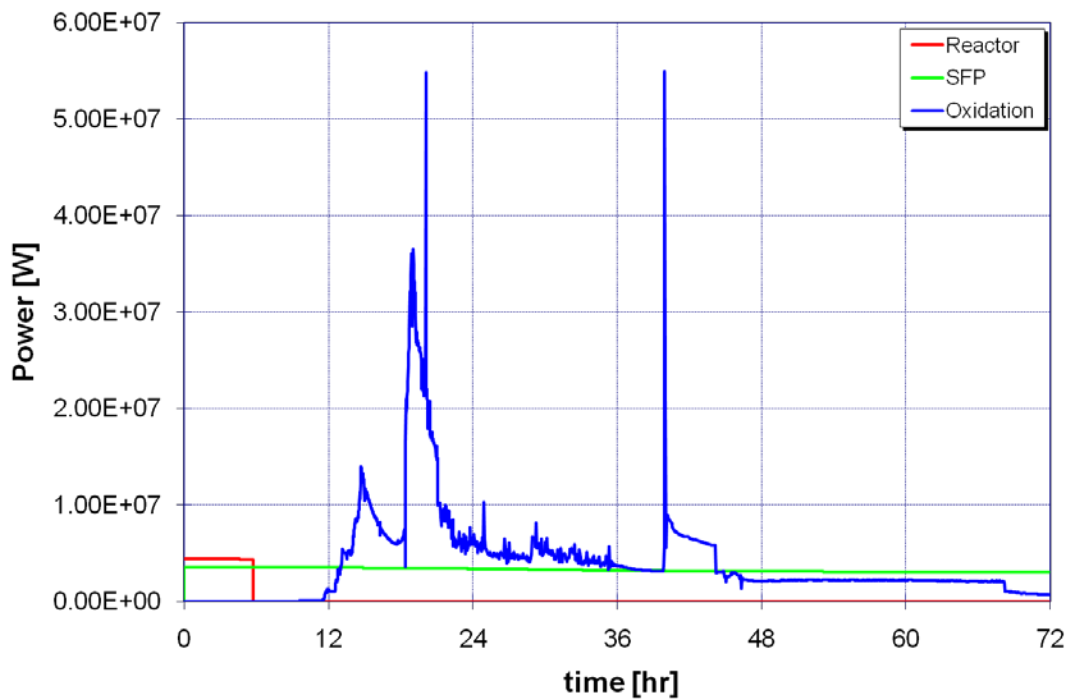


Figure 106 Reactor building mole fraction for unmitigated high-density moderate leak (OCP2-S)



**Figure 107 SFP power for unmitigated high-density moderate leak (OCP2)**



**Figure 108 SFP power for unmitigated high-density moderate leak (OCP2-S)**

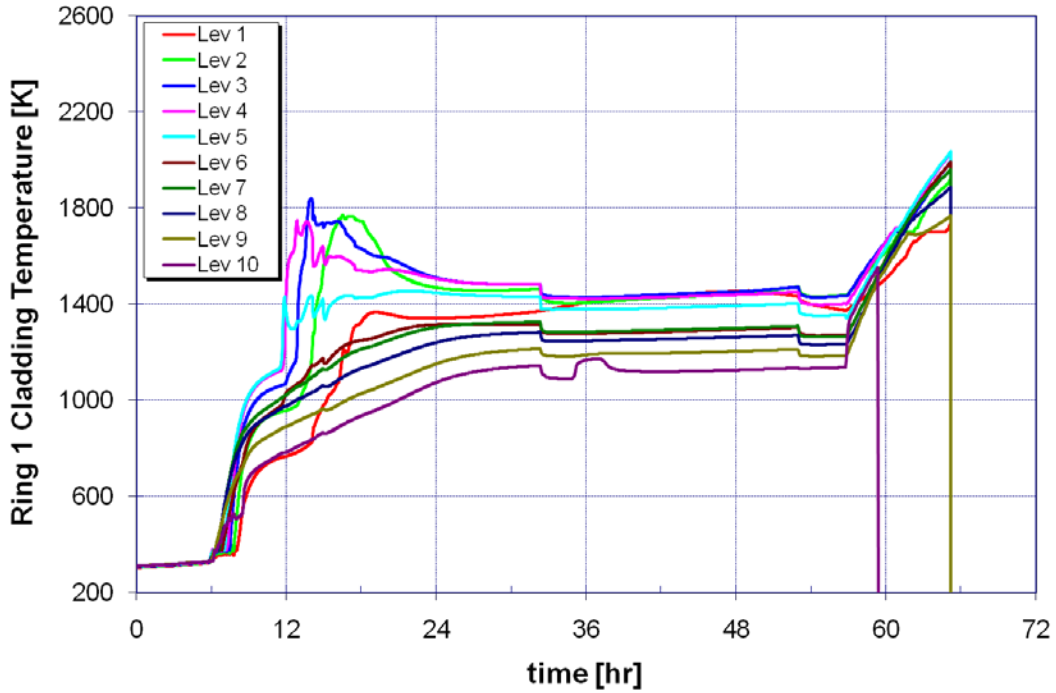


Figure 109 Ring 1 clad temperature for unmitigated high-density moderate leak (OCP2)

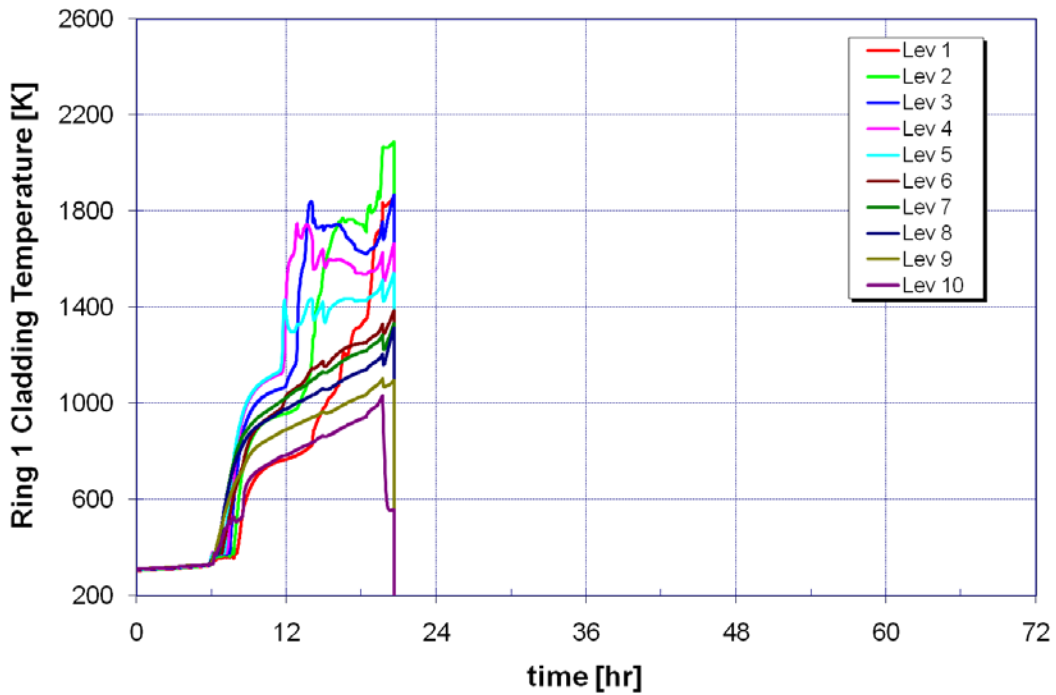


Figure 110 Ring 1 clad temperature for unmitigated high-density moderate leak (OCP2-S)

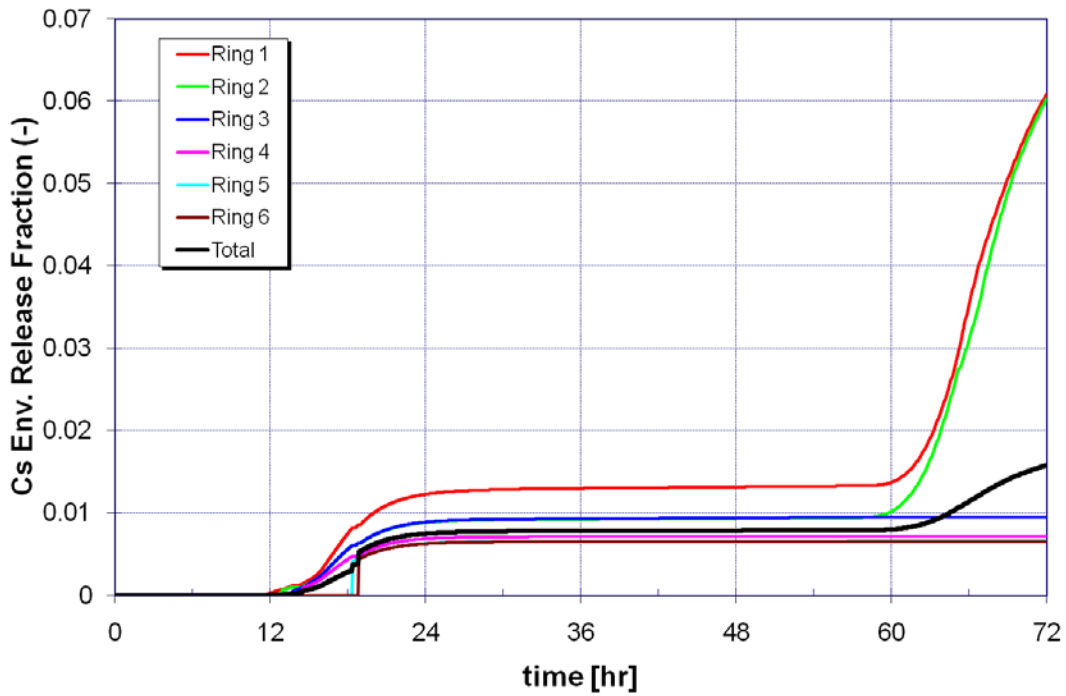


Figure 111 Cesium environmental release fraction for unmitigated high density moderate leak (OCP2)

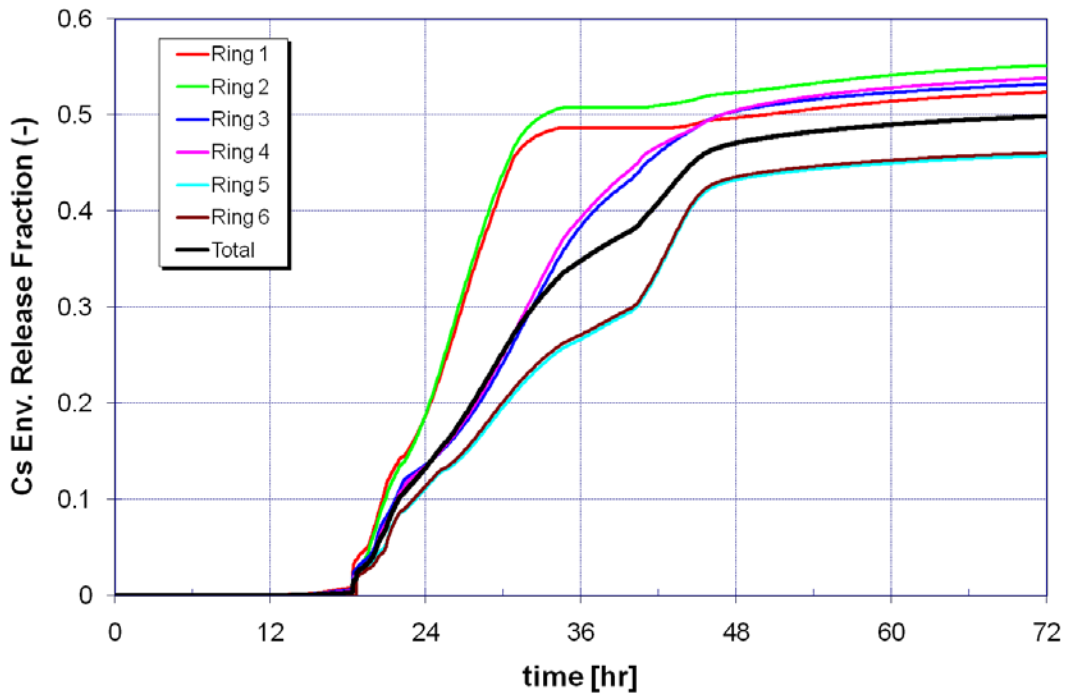


Figure 112 Cesium environmental release fraction for unmitigated high density moderate leak (OCP2-S)



## 9.2 Sensitivity to 1x8 Fuel Assembly Pattern (MELCOR)

This sensitivity involves a more favorable fuel pattern in which the hot assemblies are surrounded by eight cold assemblies. Figure 113 shows the assembly layout in a 1x8 pattern in which the 284 assemblies from the last offload are grouped into Rings 1, 3, and 5 (see Figure 46 for the 1x4 pattern). Rings 2, 4, and 6 contain all of the old fuel and have a total of 2,771 assemblies with their total decay heat distributed in each ring scaled by the number of assemblies.

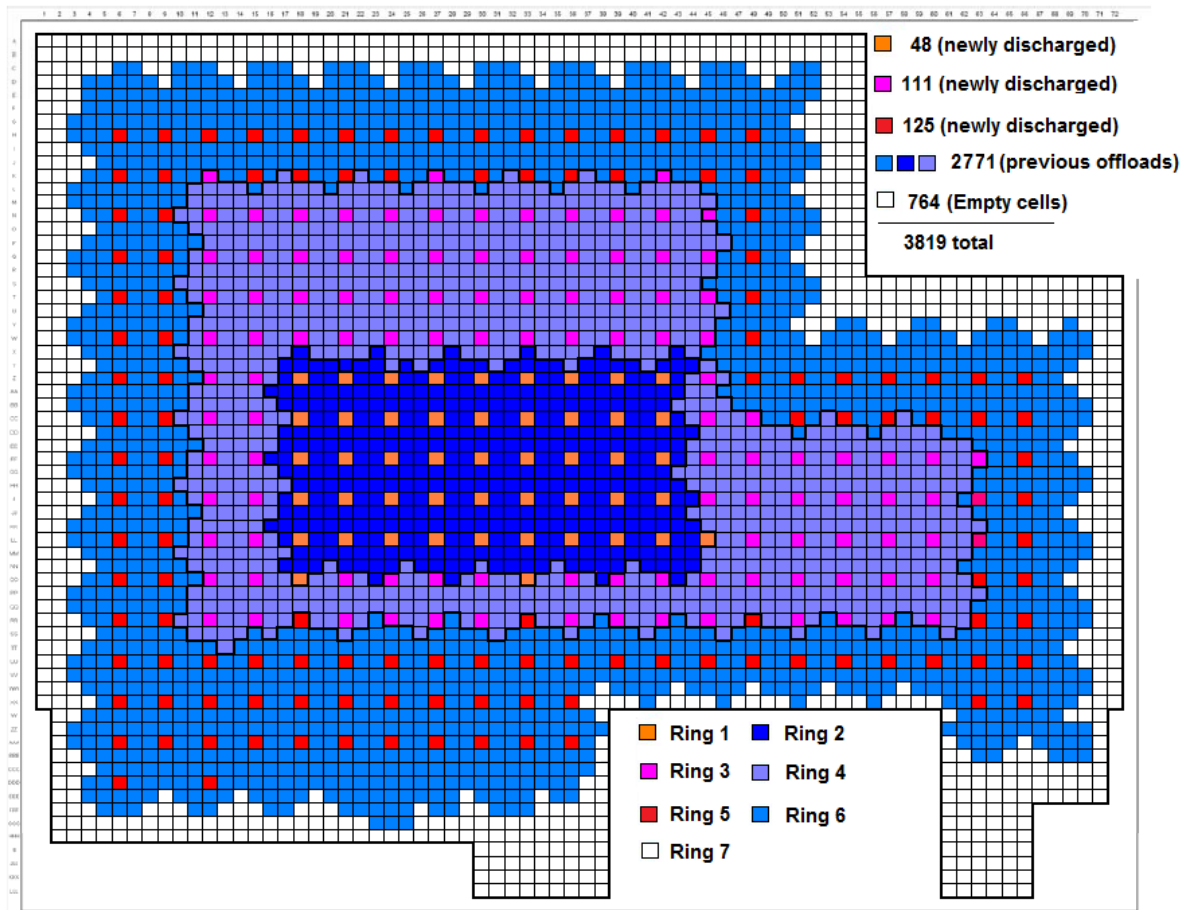


Figure 113 Layout of assemblies for OCP3 high density (1x8) model

A number of sensitivity calculations were performed for the high density, small leak scenarios in OCP2 and OCP3 (which had the highest release as a result of hydrogen combustion). Figure 114 and Figure 115 show the thermal response of the fuel in the 1x8 configuration for OCP3. Figure 114 shows that the highest power fuel assemblies in Ring 1 do not undergo a zirconium fire and the temperatures remain low enough to avoid gap release for the duration of the transient. The midplane fuel temperatures in the pool shown in Figure 115 have a more uniform heat up of the fuel assemblies than the comparable 1x4 pattern. There is more mass of the cold assemblies in the 1x8 pattern, which leads to lower heatup of the fuel. The fuel thermal response in the 1x8 pattern can be contrasted to the 1x4 pattern as shown in Figure 116 and Figure 117. For the 1x8 calculation, no release occurs from the fuel through 72 hours. In the 1x4 layout, a zirconium fire propagation began at 40 hours, which led to a 42-percent release of

cesium inventory to the environment. For the OCP2 configuration results shown in Figure 118 and Figure 119, the decay heat is high enough to cause a zirconium fire in the hottest assemblies, even though the peak fuel temperatures in the 1x8 pattern are somewhat lower. The beneficial effect of the 1x8 pattern is also evidenced by the lower release fractions, as shown in Figure 120 and Figure 121.

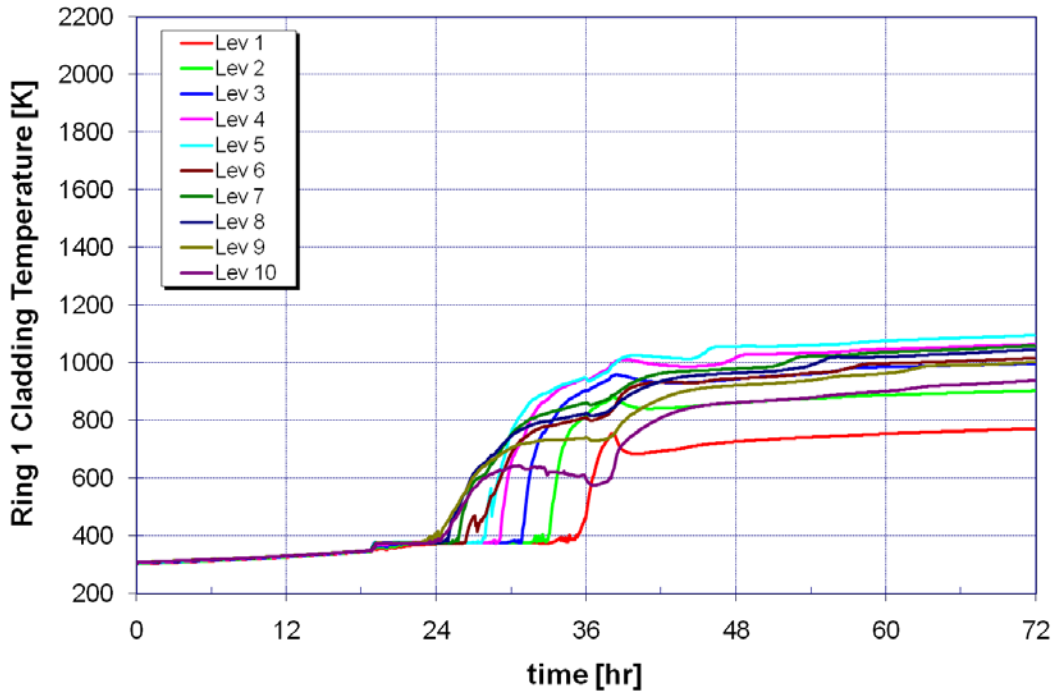


Figure 114 Ring 1 clad temperature for unmitigated high-density small leak (OCP3; 1x8)

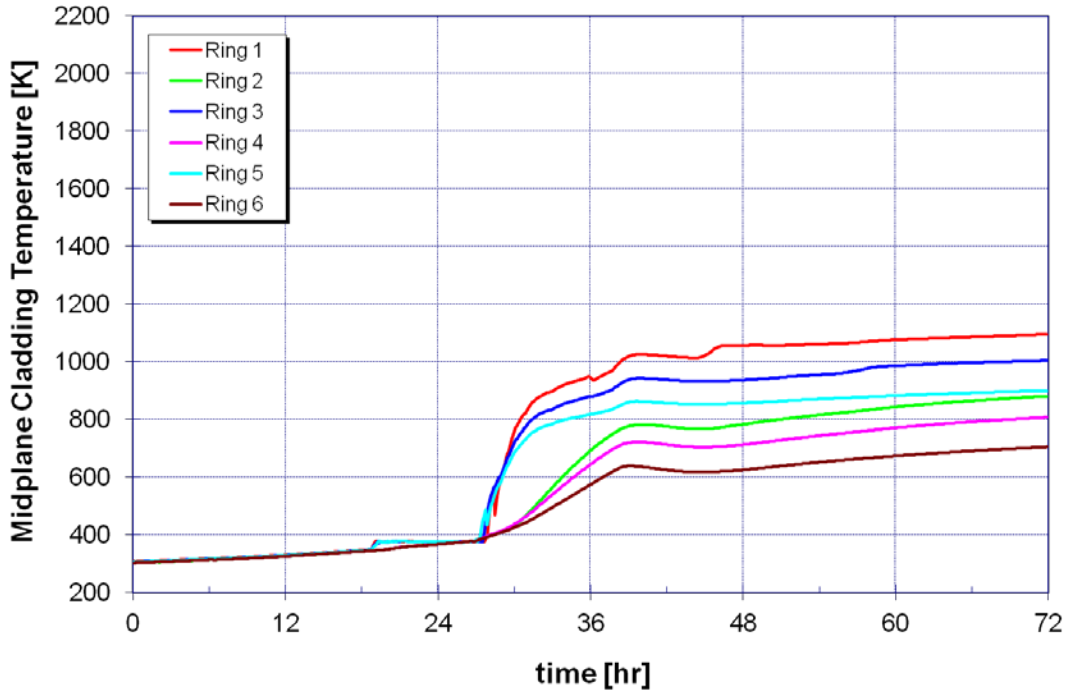


Figure 115 Midplane clad temperature for unmitigated high-density small leak (OCP3; 1x8)

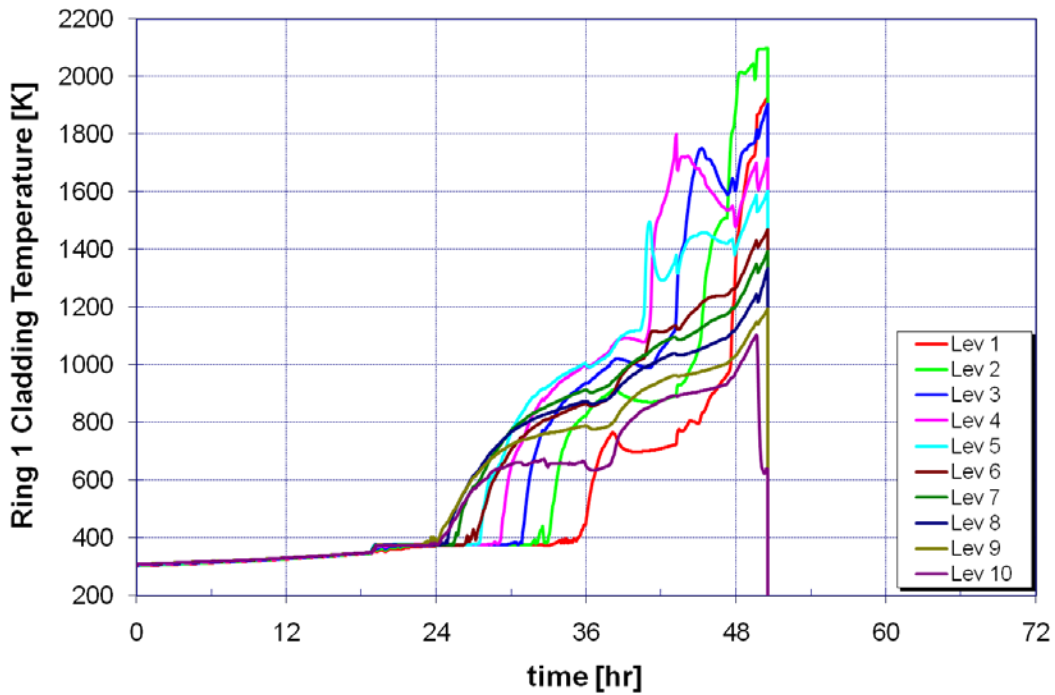
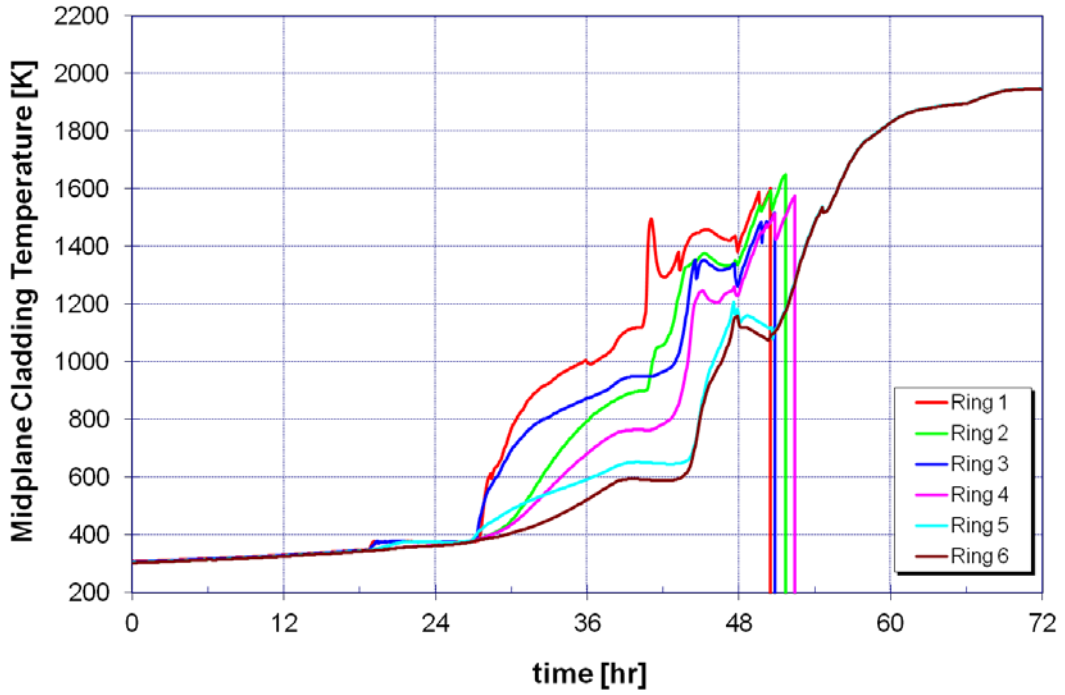
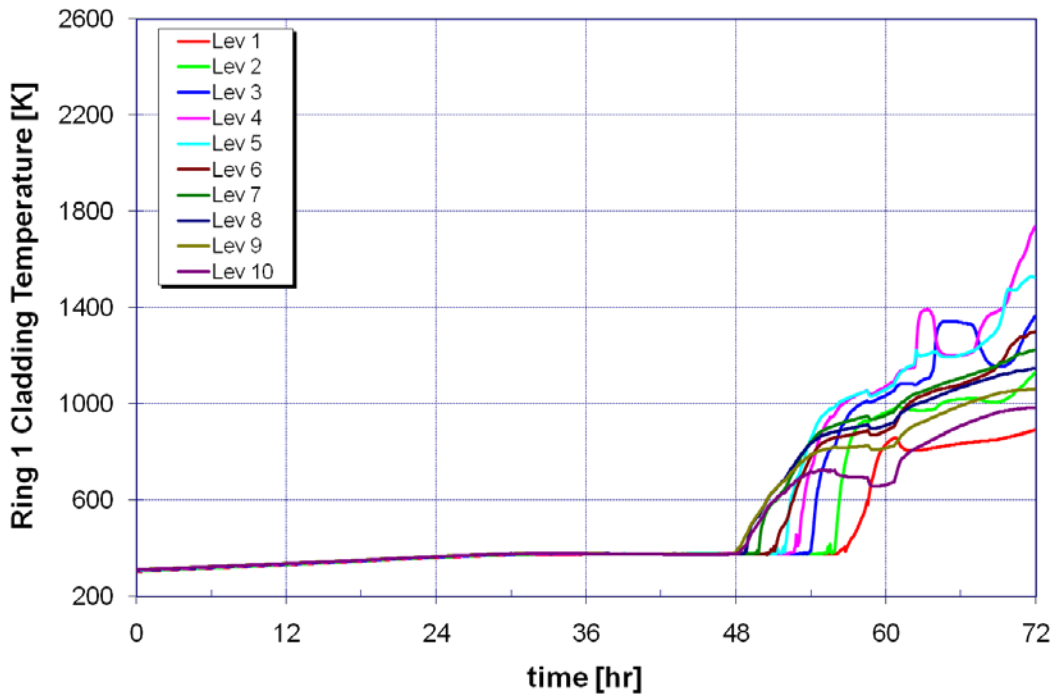


Figure 116 Ring 1 clad temperature for unmitigated high-density small leak (OCP3; 1x4)



**Figure 117 Midplane clad temperature for unmitigated high-density small leak (OCP3; 1x4)**



**Figure 118 Ring 1 clad temperature for unmitigated high-density small leak (OCP2; 1x8)**

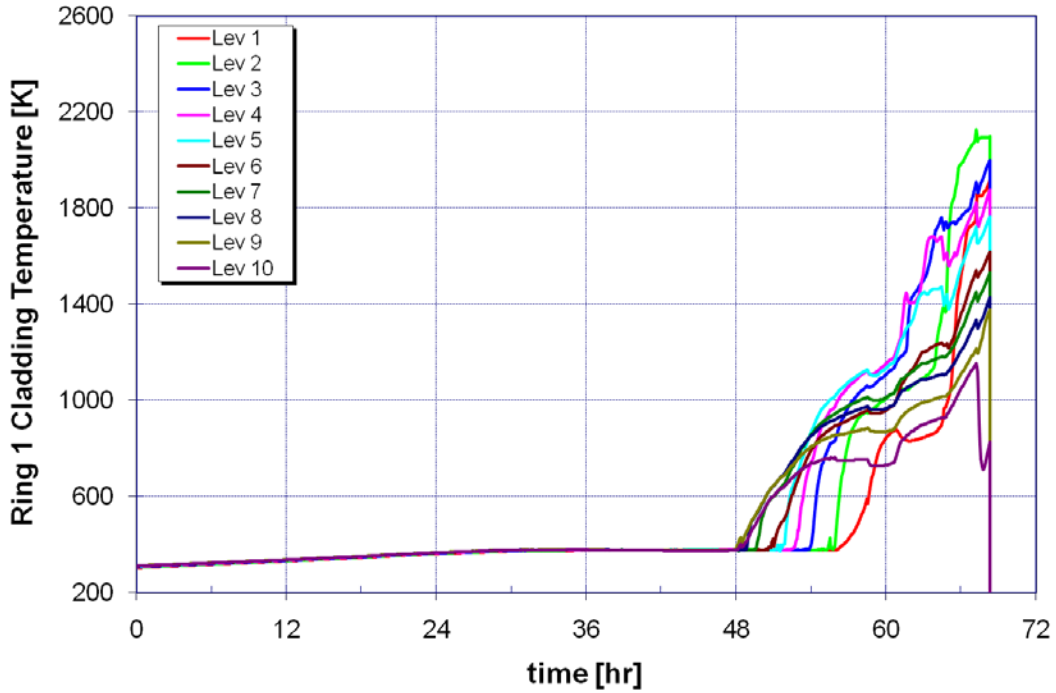


Figure 119 Ring 1 clad temperature for unmitigated high-density small leak (OCP2; 1x4)

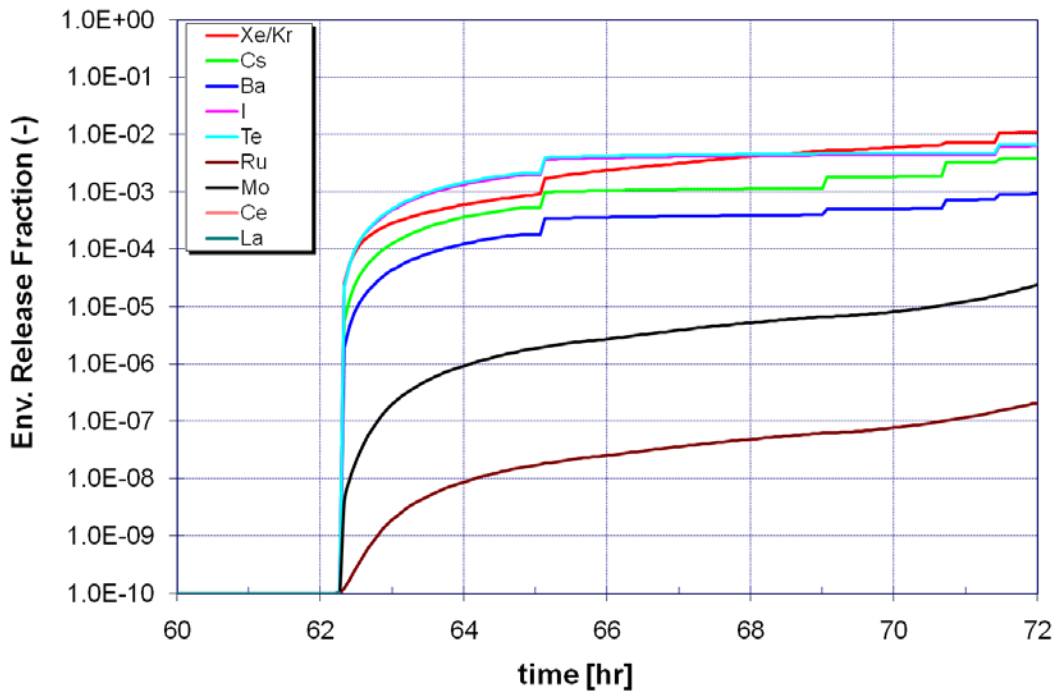
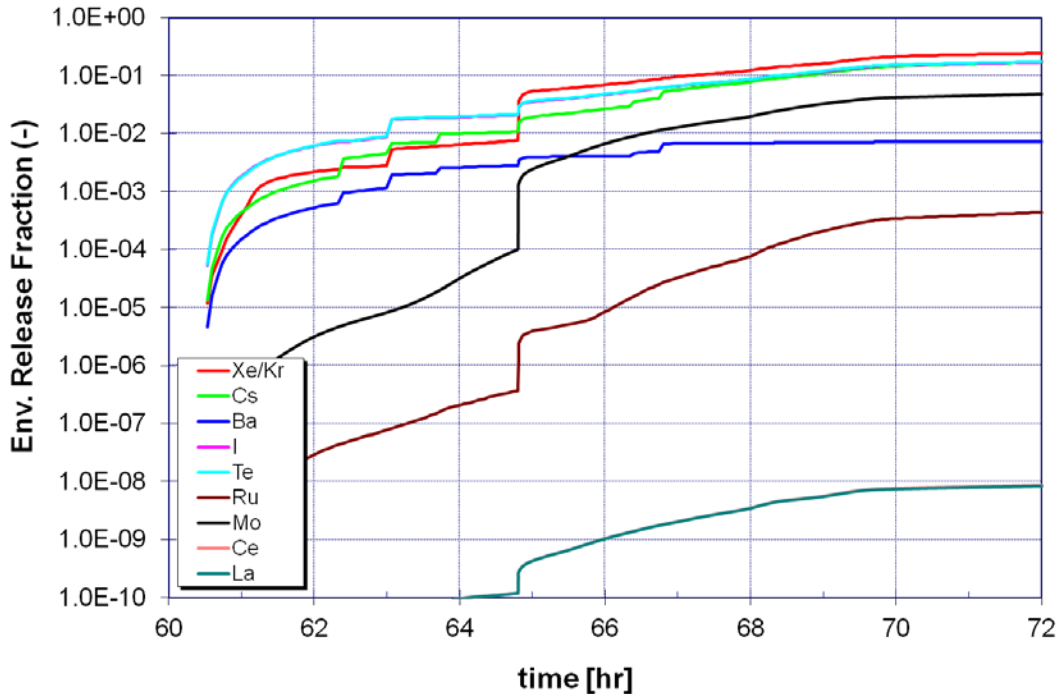


Figure 120 Environmental release fractions for unmitigated high-density small leak (OCP2; 1x8)



**Figure 121 Environmental release fractions for unmitigated high-density small leak (OCP2; 1x4)**

### **9.3 Sensitivity to a Contiguous (Uniform) Fuel Pattern during an Outage (MELCOR/MACCS2)**

The reference plant studied has prearranged the SFP such that discharged assemblies can be placed directly into a 1x4 (actually 1x8 in the case of PBAPS) arrangement for the last two outages for both operating units. This approach is consistent with the requirements previously discussed in Section 5.1. However, those requirements do allow for the fuel to be stored in a less favorable configuration for some time following discharge if other considerations prevent prearrangement. A requirement is associated with the time window by which the 1x4 arrangement must be achieved; however, the specific time requirement is not publicly available information (because it could be potentially useful to an adversary). This section posits a situation in which the fuel is unfavorably arranged during the outage to demonstrate the effect of this aspect on the results.

Figure 122 and Figure 123 show the layout of assemblies for the OCP1 and OCP2 uniform configuration. For the 1x4 pattern (see Figure 44), the effective area between Rings 1 and 2 was determined by the number of panels (i.e., 352 panels for 88 assemblies), since each assembly in Ring 1 is completely surrounded by Ring 2 assemblies. In the uniform pattern (Figure 122), the surface areas between Rings 1 and 2 and between Rings 3 and 4 were effectively reduced by about an order of magnitude, assuming that all of the assemblies in Rings 1 and 3 formed an approximate square. In the 1x4 pattern, the boundary area (per unit axial length) for Rings 1 and 3 was based on four panels per assembly. In the uniform pattern, the number of panels per assembly is estimated as 0.4 for Ring 1 ( $4(88)^{1/2}/88$ ) and 0.3 ( $4(196)^{1/2}/196$ ) for Ring 3. This is a stylized representation of a uniform configuration which limits the areas (and thus total heat transfer) between the hot rings and the rest of the assemblies in the pool.

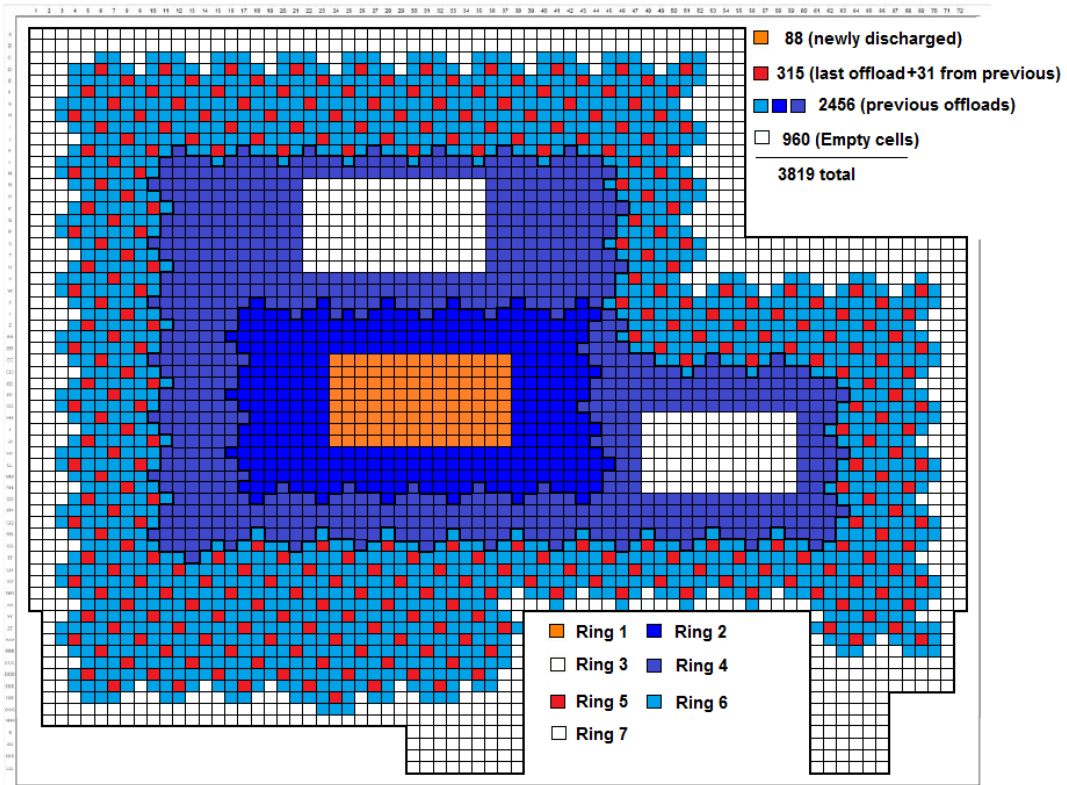


Figure 122 Layout of assemblies for OCP1 high-density (uniform) model

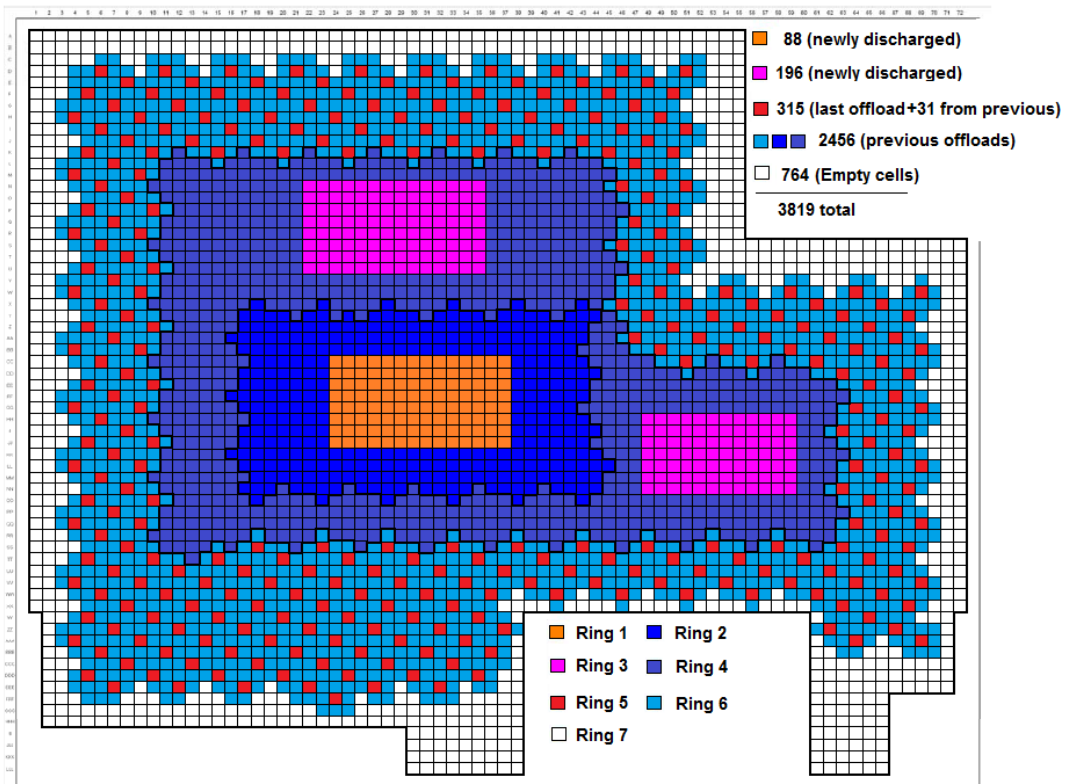


Figure 123 Layout of assemblies for OCP2 high-density (uniform) model

### Unmitigated Moderate Leak (OCP1 Uniform) Scenario

Figure 124 and Figure 125 show the results of the calculation for the uniform OCP1. A comparison of the heatup with the 1x4 geometry (Figure 67) shows the higher temperatures in the uniform Ring 1 configuration because there is less surface area between Ring 1 and the colder assemblies in Ring 2. The overall thermal response, however, is comparable. At about 30 hours, Ring 1 experiences a gradual heatup as the oxygen in the building is depleted, and formation of debris restricts airflow through the assemblies. Eventually, all of the fuel in Ring 1 collapsed and formed a debris bed. There is continuous release from Rings 1 and 2 and the overall cesium release to the environment is about twice of that in the 1x4 geometry (see Figure 72).

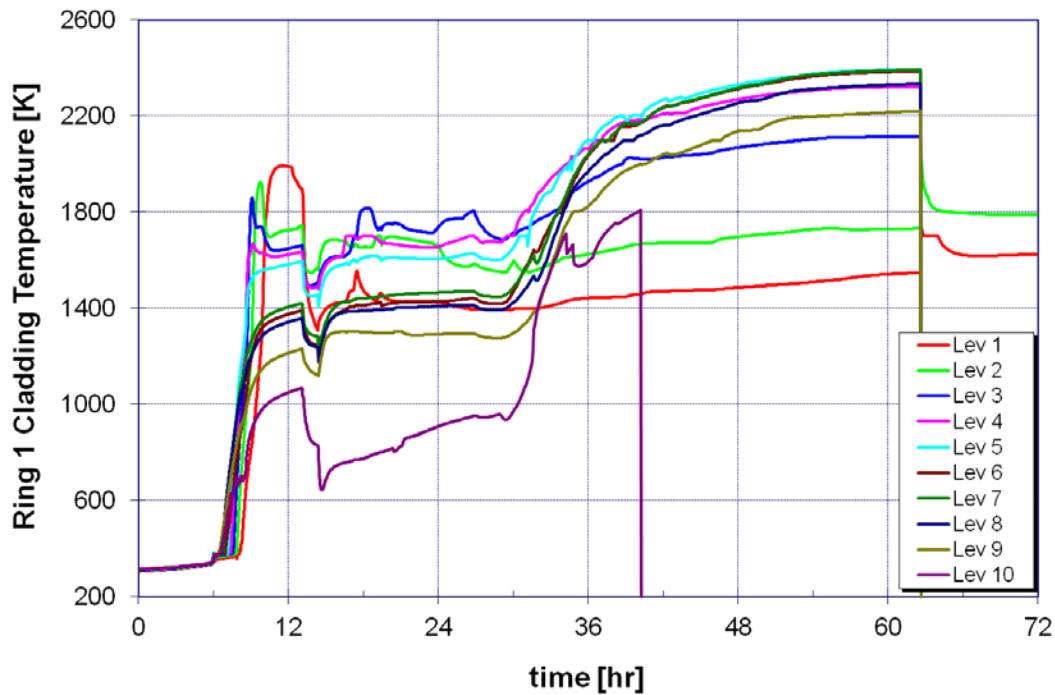
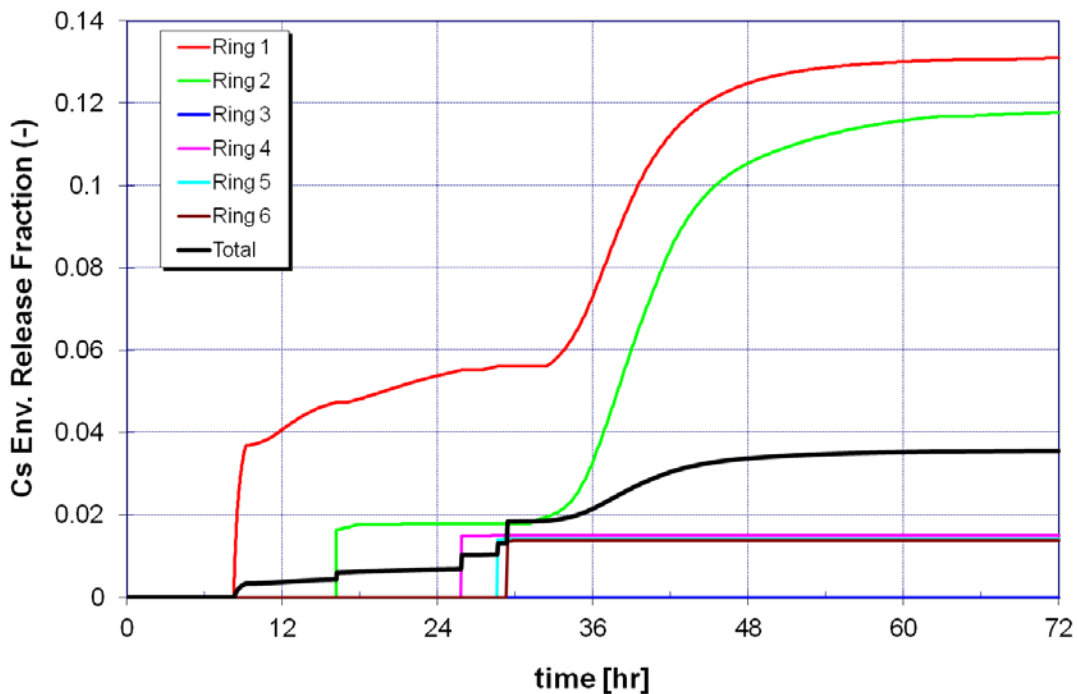


Figure 124 Ring 1 clad temperature for unmitigated uniform high-density moderate leak (OCP1)





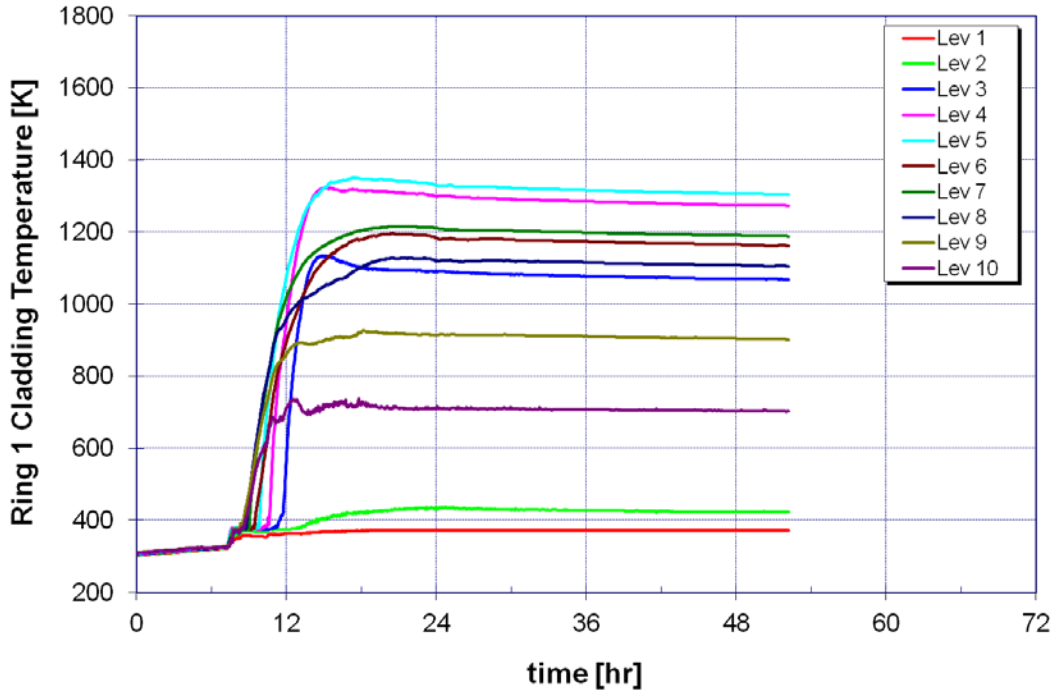
**Figure 125 Cesium environmental release fraction for unmitigated uniform high-density moderate leak (OCP1)**

#### Mitigated Moderate Leak (OCP2 Uniform) Scenario

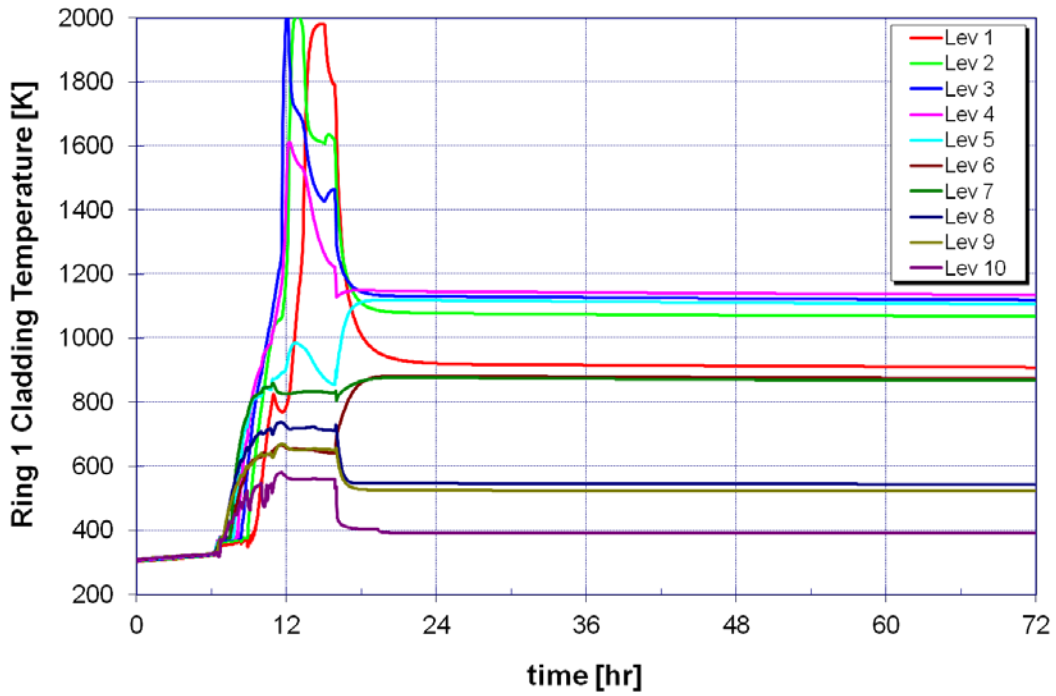
For the mitigated case in the OCP2 uniform pattern that had the highest cesium release fraction (1.2 percent), a number of calculations were performed to determine the effectiveness of mitigation. The same scenario in the 1x4 pattern did not have any release. The overall behavior of fuel temperature is similar to the 1x4 pattern cases in OCP2 (not shown) and OCP 1 (Figure 77), but the fuel is experiencing a higher temperature that gradually decreases. For this base case (Figure 126), temperatures are high enough to cause a gap release and more gradual release of fission products from the fuel. Figure 127 illustrates the calculation for the 200-gpm spray instead of the 500-gpm makeup water, which actually shows a rapid heatup before the temperatures are stabilized.<sup>43</sup> A calculation was performed to test the effectiveness of a higher spray flow rate of 500 gpm and, as indicated in Figure 128, the fuel temperature is stabilized at much lower temperatures without release of fission products from the fuel. In all of the spray calculations performed in this study, the simple flow regime model was disabled because of a more stable and faster calculation, and the previous results from OCP3 had already demonstrated that both models predict comparable maximum clad temperatures.

<sup>43</sup>

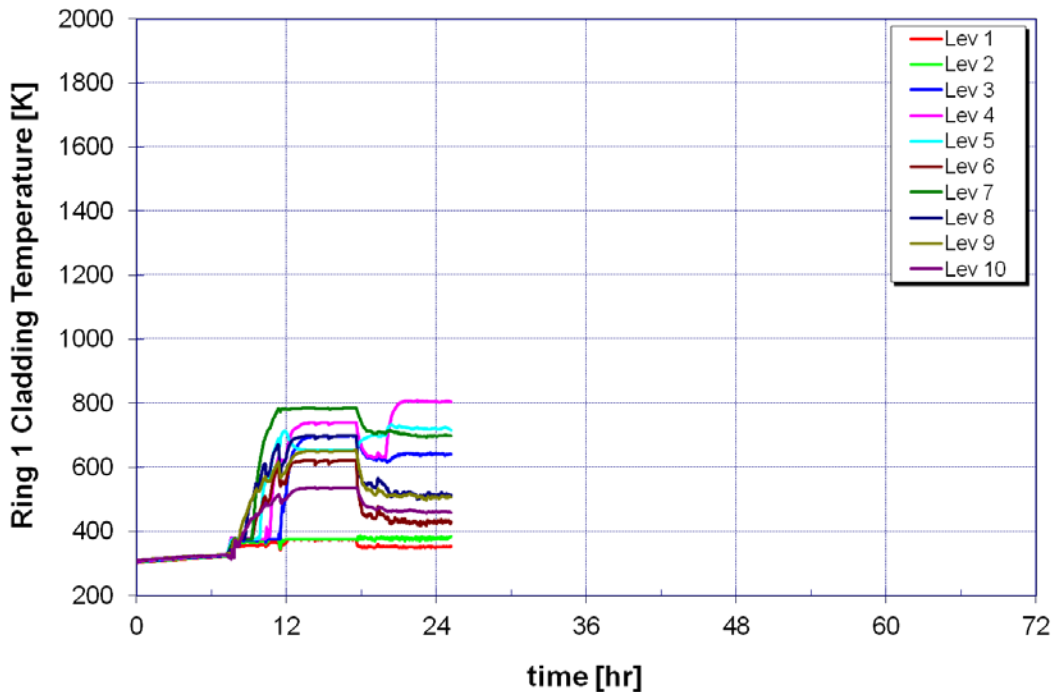
The initial higher temperature spike for the 200 gpm spray, as compared to lower temperatures for the 500 gpm injection case, results from a combination of the leakage versus makeup rate for this particular scenario. For the 500 gpm injection case, the lower portions of the assemblies are covered with water and high decay heat promotes steam cooling of the exposed portions of the fuel. A larger hole size would not have the benefit of steam cooling, and the spray is expected to perform better for a wide range of conditions. Even in this particular case, under quasi-steady conditions the fuel temperatures are generally lower for the spray case.



**Figure 126 Ring 1 clad temperature for mitigated uniform high-density moderate leak (OCP2) with 500 gpm injection**



**Figure 127 Ring 1 clad temperature for mitigated uniform high-density moderate leak (OCP2) with 200 gpm spray**



**Figure 128 Ring 1 clad temperature for mitigated uniform high density moderate leak (OCP2) with 500 gpm spray**

**Table 50 Summary of Release Characteristics for High-Density, Uniform Pattern**

High Density Case #	Scenario Characteristics					Release Characteristics			
	SFP Leakage?	50.54 (hh)(2) Equipment?	Fuel Uncovery (hr)	Gap Release (hr)	Hydrogen Deflagration (hr)	Cs release at 72 hours	Cs-137 (MCi) Released	I release at 72 hours	I-131 (MCi) Released
OCP1	Small	No	39.7	52.3	No	0.8%	0.41	4.8%	0.38
	Moderate	Yes	7.4	11.7	No	0.6%	0.32	0.6%	0.05
	Moderate	No	5.9	8.2	No	3.6%	1.88	12.4%	0.97
OCP2	Small	No	42.6	55.2	65.4	4.2%	1.93	5.5%	0.61
	Moderate	Yes	7.3	12.7	No	1.2%	0.55	5.0%	0.56
	Moderate	No	5.9	8.8	21.6	49.1%	22.71	68.4%	7.65

For the offsite consequence analysis, the sequences with recently discharged fuel in a uniform configuration were binned in a similar manner to the low-density and high-density (1x4) loading scenarios. Since the licensee must either preconfigure the SFP to allow direct placement of discharged fuel in or move their recently discharged fuel to a more favorable configuration after a certain amount of time, this sensitivity simply assumes that the high-density uniform case becomes identical to the high-density (1x4) case after OCP2 (i.e., that the actions to meet the requirements on fuel pattern discussed in Section 5.1 are taken at the end of OCP2). While the uniform case has different release categories, the situations that lead to release are largely the same as the low-density and high-density (1x4) base cases. The one exception is for OCP2 with a moderate leak and deployed 10 CFR 50.54(hh)(2) equipment, in which case a successful

deployment of mitigation equipment is expected to prevent release for the high-density (1x4) and low-density scenario, but not for the sensitivity scenario of recently discharged fuel in a uniform configuration.

**Table 51 Listing of Uniform Pattern Release Sequences**

High Density (uniform) Loading							
Unsuccessful mitigation				Deployed 50.54(hh)(2)			
Sequence		Release Frequency (/yr)*	Release Category	Sequence		Release Frequency (/yr)	Release Category
OCP1	small leak	6E-09**	RC12	OCP1	mod leak	6E-09	RC11
	mod leak	6E-09	RC23	OCP2	mod leak	2E-08	RC23
OCP2	small leak	2E-08	RC23	No Release			
	mod leak	2E-08	RC33				
OCP3	small leak	4E-08	RC33				
	mod leak	4E-08	RC11				
Total		1E-07					

\* Release frequency = initiating event frequency \* ac power fragility \* OCP probability \* liner fragility for the specified leak size (see Section 5.6.3 for conditional probabilities)

\*\* Example calculation:  $1.7 \times 10^{-5} / \text{yr} \cdot 0.84 \cdot 0.0086 \cdot 0.05 = 6 \times 10^{-9} / \text{yr}$

Table 52 reports the consequence results for the sensitivity scenario of recently discharged fuel in a uniform configuration. It is similar to Table 33 for the base scenarios.

**Table 52 Uniform Pattern Consequence Results**

SFP Fuel Loading	High Density (uniform)	
Seismic Hazard Frequency <sup>1</sup> (/yr) (PGA of 0.5 to 1.0g)	1.7E-05	
50.54(hh)(2) Mitigation Credited	Yes	No
Conditional <sup>2</sup> Probability of Release	0.14%	0.69%
Hydrogen Combustion Event	“Not Predicted”	“Possible”
Conditional <sup>3</sup> Consequences (Release Frequency-Averaged <sup>4</sup> )		
Cumulative Cs-137 Release at 72 hours (MCi)	0.5	11
	Measures Related to Individual Health and Safety	
Individual Early Fatality Risk	0	0
Individual Latent Cancer Fatality Risk <sup>5</sup> Within 10 Miles	7.3E-04 <sup>(7)</sup>	6.9E-04
	Measures Related to Cost Benefit Analysis	
Collective Dose (Person-Sv)	1.4E+05	4.9E+05
Land Interdiction <sup>6</sup> (mi <sup>2</sup> )	1.1E+03	1.3E+04
Long-term Displaced Individuals <sup>6</sup>	6.2E+05	5.6E+06
Consequences per year (Release Frequency-Weighted <sup>4</sup> )		
Release Frequency (/yr)	2.3E-08	1.2E-07
	Measures Related to Individual Health and Safety	
Individual Early Fatality Risk (/yr)	0	0
Individual Latent Cancer Fatality Risk <sup>5</sup> Within 10 Miles (/yr)	1.7E-11	8.1E-11
	Measures Related to Cost Benefit Analysis	
Collective Dose (Person-Sv/yr)	3.1E-03	5.7E-02
Land Interdiction <sup>6</sup> (mi <sup>2</sup> /yr)	2.5E-05	1.5E-03
Long-term Displaced Individuals <sup>6</sup> (Persons/yr)	1.4E-02	6.7E-01

<sup>1</sup> Seismic hazard model from USGS (Peterson et al., 2008)

<sup>2</sup> Given specified seismic-event occurs

<sup>3</sup> Given atmospheric release occurs

<sup>4</sup> Results from a release are averaged over potential variations in leak size, time since reactor shutdown, population distribution, and weather conditions (as applicable); additionally, “release frequency-weighted” results are multiplied by the release frequency.

<sup>5</sup> LNT and population-weighted

<sup>6</sup> 1st year post-accident; calculation uses a dose limit of 500 mrem per year, according to Pennsylvania Code, Title 25 § 219.51

<sup>7</sup> Slightly higher conditional risk with mitigation is due to a more prolonged release (allowing changes in wind direction to affect additional portions of the 10 mile area) and effective protective actions that limit individual risk (regardless of release magnitude); the difference is small compared to the reduction in release frequency.

The insights of the high density 1x4 scenario are also applicable here to the uniform pattern: There is very small likelihood of release. When there is a release, no offsite early fatalities attributable to acute radiation exposure are predicted. On average, significant land contamination is predicted when there is a release with unsuccessfully deployed mitigation. A significant numbers of latent cancer fatalities are also estimated; however, this is a small fraction of cancer fatalities from all causes, because protective actions are expected to keep doses below limits for habitation and ingestion. Overall, individual latent cancer fatality risk is very low, mainly because of the very small likelihood of release and protective actions.

Health effects that would be induced by low dose radiation are uncertain, and insights from a dose truncation for the uniform pattern scenario are similar to those for the high density 1x4 scenario. As can be seen in Table 53, dose truncation significantly lowers the estimated number of total latent cancer fatalities because the uncertain effects of small individual doses are excluded.

**Table 53 Dose Truncation Comparison for Uniform Pattern**

Dose-Response	High Density (1x4)	
50.54(hh)(2) Mitigation Credited	Yes	No
Conditional <sup>1</sup> Individual Latent Cancer Fatality Risk Within 10 Miles (Release Frequency-Averaged <sup>2</sup> )		
Linear, No Threshold	7.3E-04 <sup>(3)</sup>	6.9E-04
620 mrem/yr truncation	3.2E-07	1.1E-06
5rem/yr or 10rem lifetime truncation	2.3E-07	1.1E-06
Individual Latent Cancer Fatality Risk Within 10 Miles (/yr) (Release Frequency-Weighted <sup>2</sup> )		
Linear, No Threshold	1.7E-11	8.1E-11
620 mrem/yr truncation	7.3E-15	1.3E-13
5 rem/yr or 10 rem lifetime truncation	5.3E-15	1.3E-13

<sup>1</sup> Conditional on a release occurring

<sup>2</sup> Results from a release are averaged over potential variations in leak size, time since reactor shutdown, population distribution, and weather conditions; additionally, "release frequency-weighted" results are multiplied by the release frequency.

<sup>3</sup> Slightly higher conditional risk with mitigation is due to a more prolonged release (allowing changes in wind direction to affect additional portions of the 10 mile area) and effective protective actions that limit individual risk (regardless of release magnitude); the difference is small compared to the reduction in release frequency.

Similar to the high density (1x4) scenario without deployed 50.54(hh)(2) equipment, the uniform scenario is sometimes predicted to have significant releases when there is a hydrogen combustion. Once again, this is because hydrogen combustion leads to much more zirconium oxidation from the influx of air, as well as a much smaller building decontamination factor. A comparison of this sensitivity analysis of a uniform fuel pattern and those of the base case (i.e. the high density 1x4 pattern and the low density configuration) are quantified in the Table 54 and Table 55.

**Table 54 Consequence Comparison – High Density (1x4 and Uniform) Loading Without Successful 50.54(hh)(2) Mitigation**

Benefit of High Density (1x4) vs. High Density (uniform) Fuel Loading (Scenario Specific, Weather-Averaged, Release Frequency-Averaged, Unsuccessful Deployment of 50.54(hh)(2))		
Type of Consequence	Consequences** (/yr)	Conditional* Consequences
	Reduction Factor (dimensionless)	
Release Frequency	1.0	-
Individual Latent Cancer Fatality Risk*** for 0-10 Miles	1.6	1.6
Collective Dose (Person-Sv)	1.4	1.4
Land Interdiction (mi <sup>2</sup> )	1.4	1.4
Displaced Individuals (Persons)	1.4	1.4

\* Conditional on a release occurring (frequency of 1E-7 per year, or lower)

\*\* Release Frequency-Weighted

\*\*\* Linear-No Threshold, Population-Weighted

As can be seen in Table 54, without mitigation in the high-density configurations, consequences of the uniform pattern are discernibly higher than the 1x4 pattern. While other contributors could be partially responsible for this difference, this is largely because the accident progression analysis predicts a uniform pattern to sometimes have more detrimental hydrogen combustion events than the 1x4 pattern.

Table 55 compares consequences of high and low density with a uniform pattern for the high density loading, without mitigation. This is similar to Table 37 which uses a 1x4 pattern for the high density loading; however, Table 55 has larger differences because of the larger consequences predicted from a uniform pattern.

Successfully deployed mitigation in the high density configuration lowers the release frequency and most conditional consequences for both uniform and 1x4 patterns. For both patterns, hydrogen combustions are not predicted with MELCOR when 50.54(hh)(2) mitigation is successfully deployed, and therefore the relatively large releases are also not predicted. However, deployed mitigation is not quite as effective in the uniform pattern as it is for the 1x4 pattern. Additionally, deployed mitigation is predicted to be unsuccessful at preventing an additional release in the uniform pattern scenario as compared to the 1x4 pattern. The differences in the release frequencies and conditional consequences can be seen by comparing Table 52 and Table 33.

**Table 55 Consequence Comparison – High (Uniform) Density / Low Density Loading Without Successful 50.54(hh)(2) Mitigation**

Benefit of High (Uniform) Density / Low Density Loading (Scenario Specific, Weather-Averaged, Release Frequency-Averaged, Unsuccessful Deployment of 50.54(hh)(2))		
Type of Consequence	Consequences** (/yr)	Conditional* Consequences
	Reduction Factor (dimensionless)	
Release Frequency	1.0	-
Individual Latent Cancer Fatality Risk*** for 0-10 Miles	3.4	3.4
Collective Dose (Person-Sv)	18	18
Land Interdiction (mi <sup>2</sup> )	78	78
Displaced Individuals (Persons)	70	70

\* Conditional on a release occurring (frequency of 1E-7 per year, or lower)

\*\* Release Frequency-Weighted

\*\*\* Linear-No Threshold, Population-Weighted

#### **9.4 Sensitivity to Multiunit or Concurrent Accident Events (MELCOR)**

These sensitivity calculations are intended to show the importance of the reactor building in the progression of accident in the SFP and the source term with a concurrent reactor accident. In the base calculation for a high-density, moderate leak scenario in OCP3 (see Figure 129), the fuel heats up and a zirconium fire is initiated. The reactor building refueling bay remains intact during the rapid draindown of the pool and there is very low hydrogen generation in the SFP. As the accident progresses, the atmosphere of the reactor building heats up as air is circulated through the assemblies. The oxidation of the SFP fuel depletes the oxygen in the reactor building and limits any long-term air oxidation and the associated exothermic power. Consequently, the long-term fuel heatup is limited primarily by decay heat, and the source term is relatively small (1.7-percent cesium release to the environment). The sensitivity calculations assume failure of the reactor building as a result of the hydrogen combustion caused by leakage from the containment (as evidenced from the SOARCA analysis and the Fukushima accident). The failure of the reactor building is based on the results of the PBAPS short-term SBO calculations for SOARCA (with and without reactor core isolation cooling (RCIC) blackstart). The reactor building failure times are at 8.5 hours (without RCIC blackstart) and 16.9 hours (with RCIC blackstart). It is further assumed that the failure of the reactor building and formation of debris in the pool results in a reduction of flow area at the exit of the assemblies (50 percent of nominal flow area) and increased flow losses.

Figure 130 and Figure 131 show the thermal response of the SFP with early (8.5 hours) and late (16.9 hours) failure of the reactor building. With early failure of the reactor building (before significant fuel heatup), the circulation of the cool air limits the fuel heatup and there is no release from the fuel. With the reactor building intact (Figure 129), the reactor building atmosphere keeps heating up, which limits the convective cooling of the assemblies. With late failure of the reactor building, the fuel becomes hot enough that a sudden increase in the flow of oxygen through the assemblies ignites and rapidly leads to significant air oxidation (zirconium fire). The fuel heats up leading to degradation and finally relocation (see Figure 131). This leads to 60-percent cesium release to the environment. Finally in OCP4 (see Figure 132 and Figure 133), the decay heat and peak fuel temperatures are lower. The reactor building failure



has no impact on the accident progression because the accident is not oxygen-limited. In fact, the reactor building failure (and thus lower temperature of circulating air) leads to lower fuel temperatures.

Table 56 compares the source term for low-density OCP1 for unmitigated small and medium leaks. In both cases, the loss of the reactor building, and thus the effectiveness of natural decontamination, leads to higher release by a factor of 2 to 4 depending on the radionuclide class.

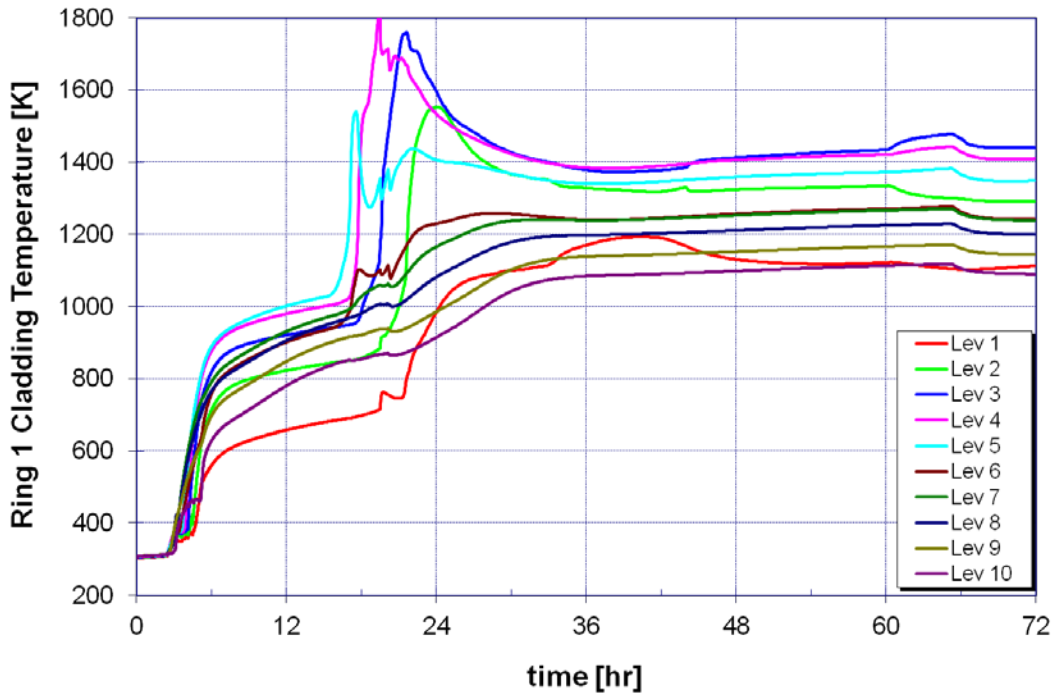
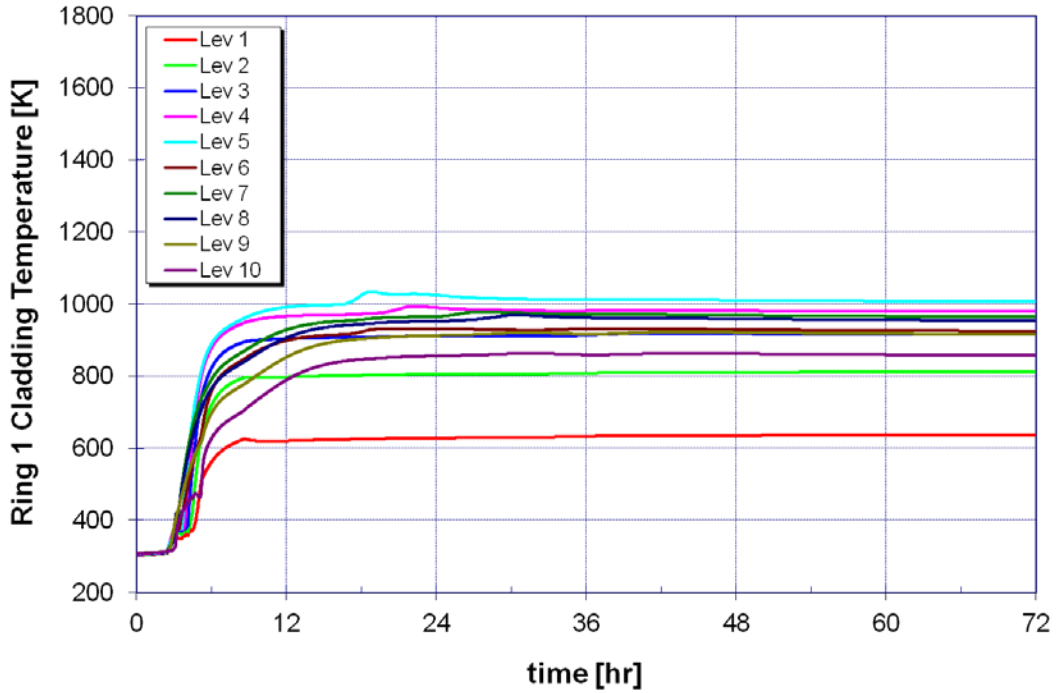
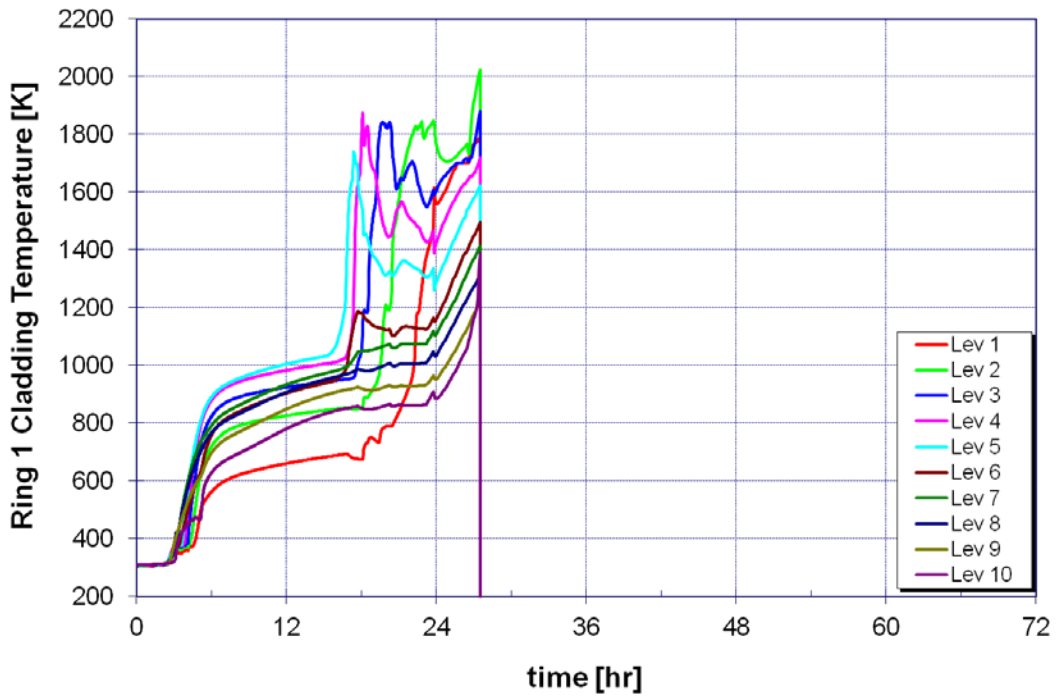


Figure 129 Ring 1 clad temperature for unmitigated high-density moderate leak (OCP3)



**Figure 130 Ring 1 clad temperature for unmitigated high-density moderate leak (OCP3; early reactor building failure)**



**Figure 131 Ring 1 clad temperature for unmitigated high-density moderate leak (OCP3; late reactor building failure)**

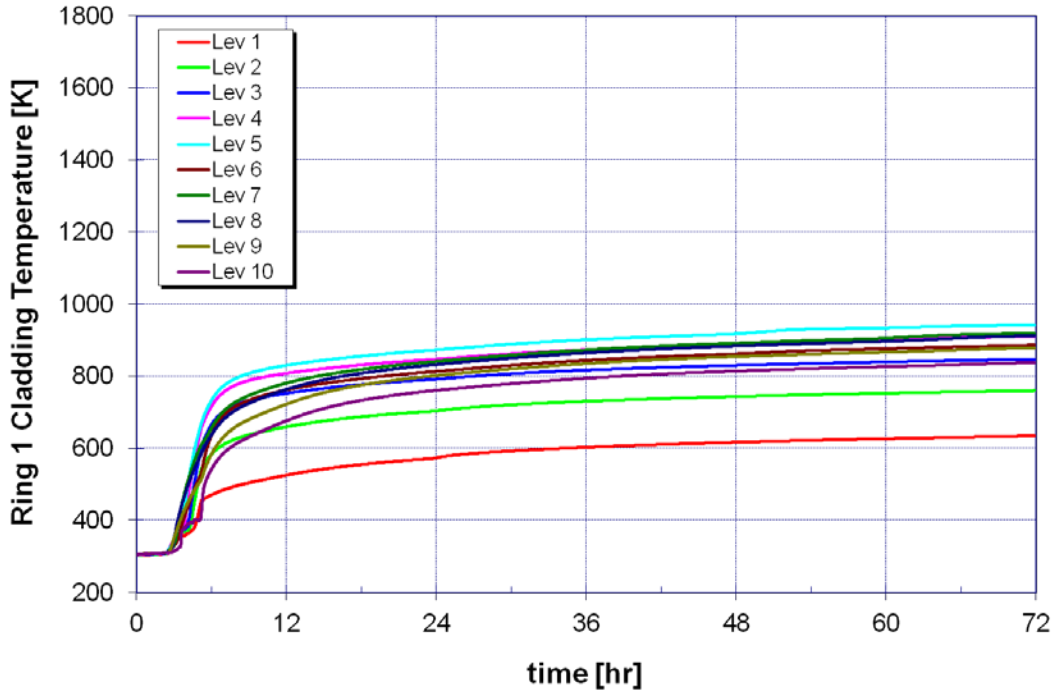


Figure 132 Ring 1 clad temperature for unmitigated high-density moderate leak (OCP4)

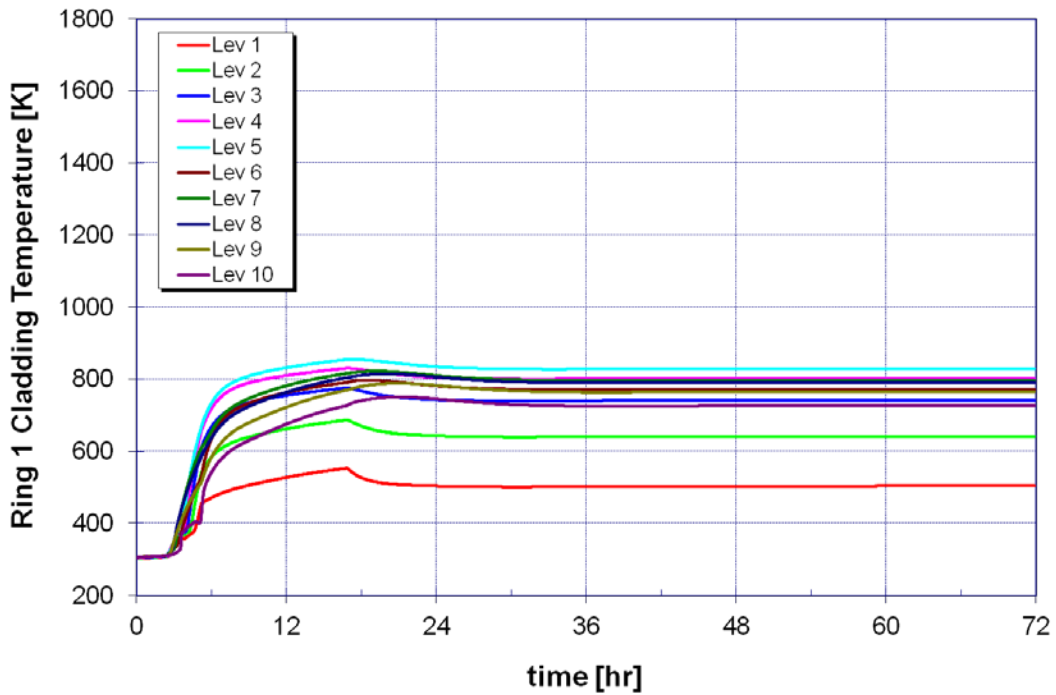


Figure 133 Ring 1 clad temperature for unmitigated high-density moderate leak (OCP4; late reactor building failure)

**Table 56 Comparison of Low-Density OCP1 Release Fractions for a Concurrent Reactor Accident**

Environmental release fraction	Small Leak		Moderate Leak	
	Base case	Late reactor building failure	Base case	Late reactor building failure
Xe/Kr	1.39E-01	1.85E-01	8.54E-02	8.87E-02
Cs	3.13E-02	1.18E-01	4.58E-03	1.49E-02
Ba	4.39E-03	9.66E-03	1.08E-03	4.45E-03
I	4.55E-02	1.41E-01	1.66E-02	5.60E-02
Te	4.54E-02	1.40E-01	1.68E-02	5.76E-02
Ru	2.17E-05	9.84E-05	2.09E-05	4.93E-05
Mo	8.86E-03	3.51E-02	2.60E-03	6.13E-03
Ce	1.49E-09	6.08E-09	4.94E-10	1.01E-09
La	1.34E-09	5.67E-09	4.37E-10	8.96E-10

## 9.5 Sensitivity to Molten Core-Concrete Interaction (MELCOR/MACCS2)

### Accident Progression Analysis (MELCOR)

This sensitivity is a variation of the previous sensitivity calculation with late reactor building failure caused by a concurrent reactor accident. Even without MCCI, the SFP concrete floor starts to heat up and by the end of 3 days, a portion of the concrete experiences temperatures in excess of its ablation temperature (assumed to be 1500 K). Figure 134 shows the contours of temperature in the SFP floor. In the present sensitivity calculation, MCCI is assumed to be initiated in a control volume that becomes active once the floor liner melts and the debris contacts the concrete. Figure 135 shows the environmental release fraction of cesium. Without MCCI, the releases from the fuel are dominated by diffusion from the fuel matrix grain boundaries as modeled in the CORSOR-Booth model in MELCOR. The MCCI releases are modeled by the VANESA model in MELCOR which takes into account sparging of the concrete decomposition of gases and the presence of metal in the melt.<sup>44</sup> The release fraction of cesium is identical in both calculations (see Figure 16) until MCCI starts in Rings 1 and 2 at about 35 hours. MCCI results in a sudden increase in cesium release (and other fission products) at 35 hours and then again at 40 hours (start of MCCI in Rings 3 and 4) as soon as zirconium is added to the melt interacting with the concrete. In general, the release fractions with MCCI are higher, and for cerium and lanthanum groups, the MCCI releases are orders of magnitude higher.

<sup>44</sup> There are some limitations in representing MCCI in a SFP using MELCOR. The MELCOR MCCI model was developed to represent a pour of core debris from a failed reactor into a confined reactor cavity. In contrast, the relocation of fuel onto the SFP liner could be highly dispersed, especially in a favorable configuration. There could be regions of low-decay heat assemblies surrounding failed high-powered assemblies or open regions under the racks where only the high-powered assemblies relocated to the SFP liner. The MELCOR MCCI model immediately mixes all debris into a uniform debris bed with uniform temperature and decay heat power. Nevertheless, the MCCI sensitivity calculations illustrate the potential impact of MCCI physics on the radionuclide chemical form (and volatility) and the associated release of radionuclides to the environment. Certain radionuclide species can become more volatile in the presences of sparging ablation gases, which leads to the differences in Table 57.

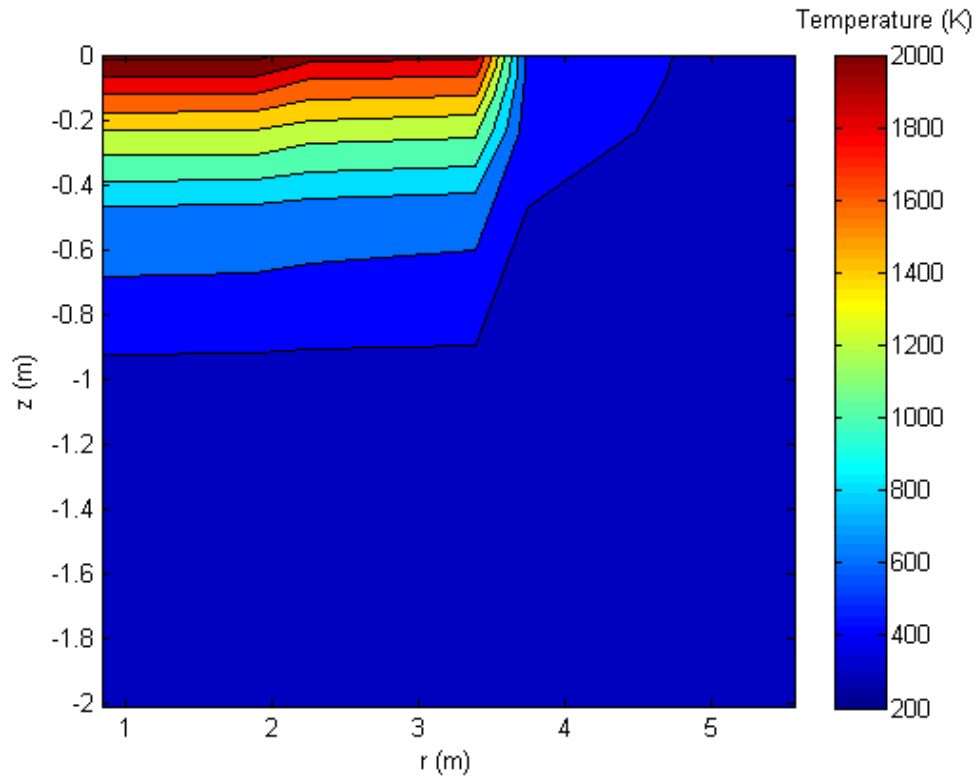


Figure 134 SFP concrete floor temperature for unmitigated high-density moderate leak (OCP3; late reactor building failure)

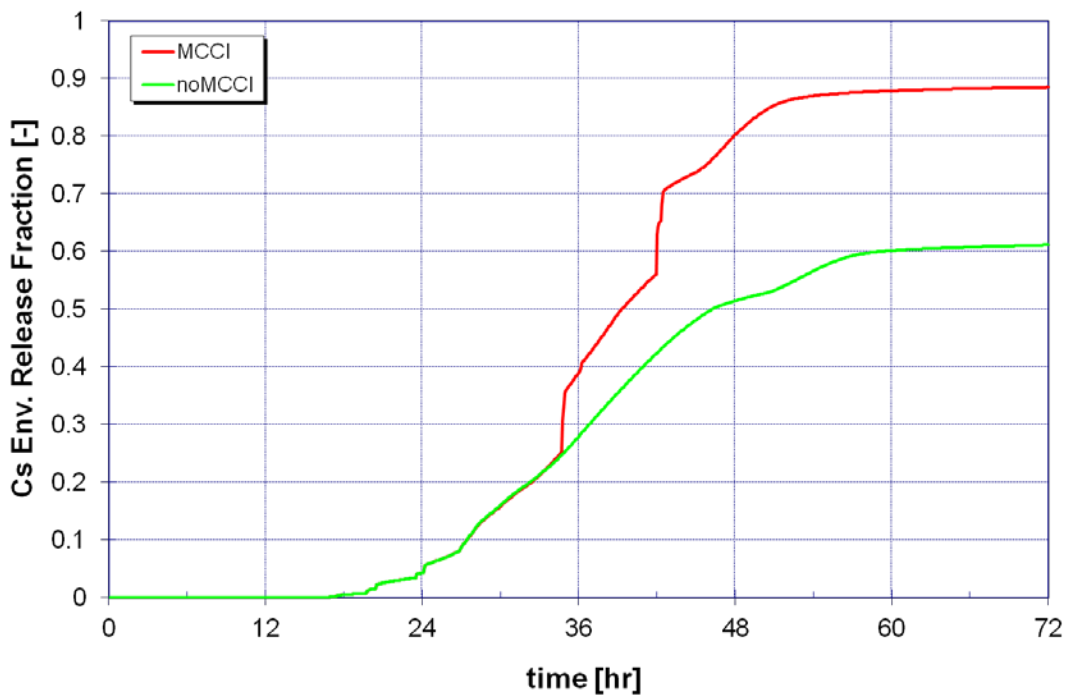


Figure 135 Cesium release fraction for unmitigated high-density moderate leak (OCP3; late reactor building failure) with and without MCCI

**Table 57 Comparison of Release Fractions with and without MCCI.**

Environmental release fraction	Without MCCI	With MCCI
Xe/Kr	0.92	0.92
Cs	0.61	0.88
Ba	0.01	0.07
I	0.83	0.91
Te	0.80	0.74
Ru	0.01	0.003
Mo	0.15	0.11
Ce	1.7E-07	0.007
La	1.6E-07	0.0002

**Offsite Consequence Analysis (MACCS2)**

The sequence used in the accident progression analysis was analyzed with MACCS2 to understand how MCCI affects offsite consequences. The sequence analyzed was the OCP3 moderate leak scenario, with hydrogen combustion in the refueling bay at 16.9 hours as predicted from the SOARCA short-term SBO with RCIC blackstart scenario.

The focus of this study was specifically on the SFP, and therefore, this sequence is not part of the main results. Rather, these are part of a different sensitivity investigating the effects of concurrent reactor events. Therefore both sequences with and without MCCI were calculated with MACCS2 in order to focus on MCCI. The individual consequence results of these sequences are not reported; however the effect of MCCI on the offsite results is shown in Table 58.

**Table 58 Consequence Comparison – Molten Core Concrete Interaction**

Molten Core Concrete Interaction Sensitivity (Weather-Averaged; OCP3 Moderate Leak sequence with reactor building failure at 16.9 hours)	
Type of Consequence	Conditional* Consequences
	Percent Increase
Individual Latent Cancer Fatality Risk** for 0-10 Miles	-17%
Collective Dose	9%
Land Interdiction (mi <sup>2</sup> )	33%
Displaced Individuals (Persons)	17%

\* Conditional on a release occurring (frequency of 1E-7 per year, or lower)

\*\* Linear-No Threshold, Population-Weighted

No early fatalities are predicted for these sequences. These sequences have considerable release fractions, including increased contributions from some of the typically non-volatile chemical groups. However, these characteristics were not enough to reach the dose thresholds associated with early fatalities in OCP3, for which the last fuel offload has cooled for 37 days since shutdown.

Although the release is larger with MCCI, the individual LCF risk for 0-10 miles non-intuitively decreases. The reason for this is likely due to the significant level of protective actions and the type of radionuclides in the different source terms. The radionuclides in the MCCI sensitivity

likely have different dose contributions relative to their LCF risk contribution, and therefore are more likely to cause protective actions despite having relatively lower risk factors, which in turn causes lower LCF risk.

To verify this phenomenon, the risk and dose contributions of different radionuclides to offsite consequence could be investigated. This is not done here; however, when farther distances are included (which are areas where protective actions and this phenomenon are less likely to occur), this reduction in the results no longer exists. This can be seen in the effect of MCCI on the collective dose in Table 58. Similarly, land interdiction and displaced individuals have higher consequences, as one may expect with relatively larger source terms.

### 9.6 Sensitivity to Radiative Heat Transfer (MELCOR)

For this sensitivity calculation, the surface area between Rings 2 and 4, Rings 4 and 6, and Rings 6 and 7 are modified by plus or minus 25 percent. Although Rings 2, 4 and 6 are empty, they still contain rack components and can impact the heatup in Rings 1, 3, and 5. Table 59 reports the results of the calculation for the unmitigated small leak (OCP2), low-density configuration. In general, the highest differences are observed for the reduction in the area (approximately 30-percent reduction in the release of volatiles), while increasing the surface area only has a modest effect on the release. The fuel heatup, radiation between rack components, initiation of air cooling, and interaction between different assemblies and racks are all complex phenomena that contribute to fission product release in a nonlinear fashion. Nevertheless, the releases for the low-density case are still small, and uncertainties in radiation modeling do not seem to significantly change the results

**Table 59 Low-density OCP2 Release Fraction Sensitivity to Ring-Ring Radiation**

	Base Case	-25% surface area	+25% surface area
Xe/Kr	4.41E-02	4.44E-02	4.40E-02
Cs	1.71E-02	1.23E-02	1.66E-02
Ba	5.19E-03	3.69E-03	5.06E-03
I	3.31E-02	2.50E-02	3.22E-02
Te	3.54E-02	2.53E-02	3.45E-02
Ru	9.27E-07	9.27E-07	8.75E-07
Mo	9.95E-05	9.93E-05	9.39E-05
Ce	3.54E-11	4.03E-11	3.16E-11
La	3.58E-11	4.06E-11	3.19E-11

### 9.7 Sensitivity to Land Contamination (MACCS2)

The measure of contaminated land area can vary significantly with the criterion used to measure or estimate the level of contamination. This study calculates the land that exceeds 500 mrem in the first year after the accident as an indicator for land contamination, based on the Pennsylvania 500 mrem annual dose limit for habitability. However, other protective action levels exist that can also be used as an indicator for measuring land contamination. These protective actions tend to be related to dose levels associated with either land interdiction or decontamination, but not necessarily.

Radioactivity levels are not typically used as a basis for protective actions. Instead, activity levels are usually measurements for estimating different dose levels, which are in turn used as the basis for protective actions. A range of typical activity levels for Cs-137 is included in the

table below. These particular levels have been widely reported as the zoning criteria for the Chernobyl nuclear disaster.

The EPA intermediate phase PAG levels are 2 rem in the first year, and 500 mrem annually thereafter. Previous studies have typically used one criterion (4 rem in 5 years) to represent these PAG levels. How well this represents the actual EPA PAG levels was not analyzed here, although this criterion is included here.

For simplicity, this sensitivity was based on the weather-average results of a single accident sequence. This is unlike the results of the production analyses, which are frequency-weighted averages of all the release sequences. The sequence chosen was the OCP3 small leak from a high density SFP with unsuccessful deployment of 50.54(hh)(2) equipment, which has a cesium release fraction of 42% at 72 hours. Since the consequence results of individual sequences are not reported, the results of this sensitivity have been normalized.

**Table 60 Consequence Comparison – Land Contamination Sensitivity**

Total Land Area Sensitivity to Dose/Activity Criteria (Weather-Averaged; OCP3 Small Leak from high density SFP with unsuccessful deployment of 50.54(hh)(2) equipment)		
Dose		
Protective Action Basis	Dose Level <sup>1</sup>	Land Area
EPA intermediate phase PAG <sup>2</sup> : 1st year	2 rem	21%
EPA intermediate phase PAGs <sup>2</sup> (as commonly represented in previous studies)	4 rem / 5 years	32%
Pennsylvania dose limit to the public	500 mrem	100%
ICRP recommendation <sup>3</sup>	100 mrem	361%
10CFR Part20 Subpart D		
10CFR Part20 Subpart E <sup>4</sup>	25 mrem	731%
Activity		
Protective Action Basis	Activity Level (Cs-137 Bq/m <sup>2</sup> )	Land Area
-	1.48E+06	73%
-	5.55E+05	181%
-	1.85E+05	346%
-	3.70E+04	557%

<sup>1</sup> Annual doses, unless otherwise noted

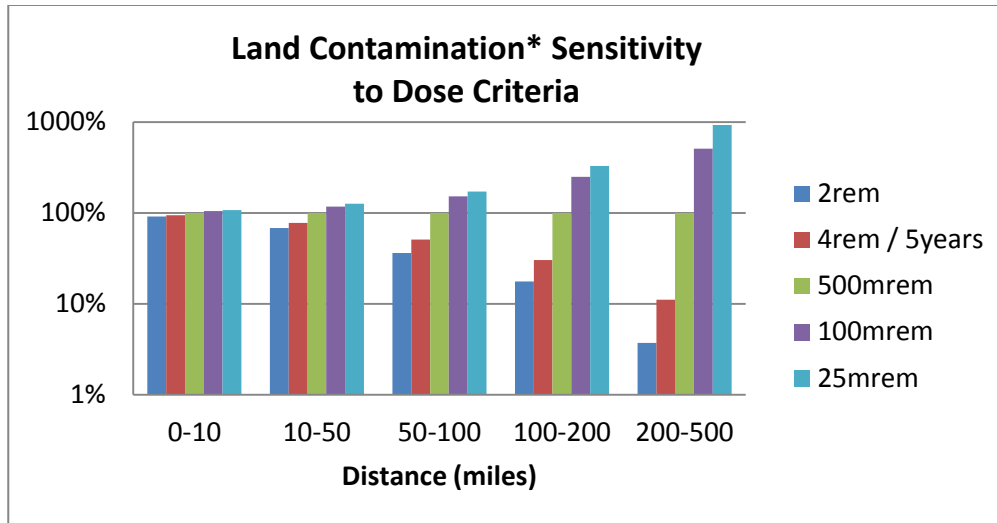
<sup>2</sup> EPA intermediate phase PAGs are: 2 rem in the first year, and 500mrem annually thereafter.

<sup>3</sup> ICRP recommends using the lower portion of a band that spans 1-20 mSv as a reference level for protective measures, and past experience demonstrates 1mSv is typical.

<sup>4</sup> 10CFR Part20 Subpart E also includes ALARA, which is not considered here.

As seen from the table above, different dose or activity levels can significantly change the amount of land area that exceeds a given limit. In addition to the total land area, a range of different distances were also analyzed in the graph below.





\*Weather-averaged; OCP3 Small Leak from high density SFP with unsuccessful deployment of 50.54(hh)(2) equipment

**Figure 136 Land Contamination Sensitivity to Dose Criteria**

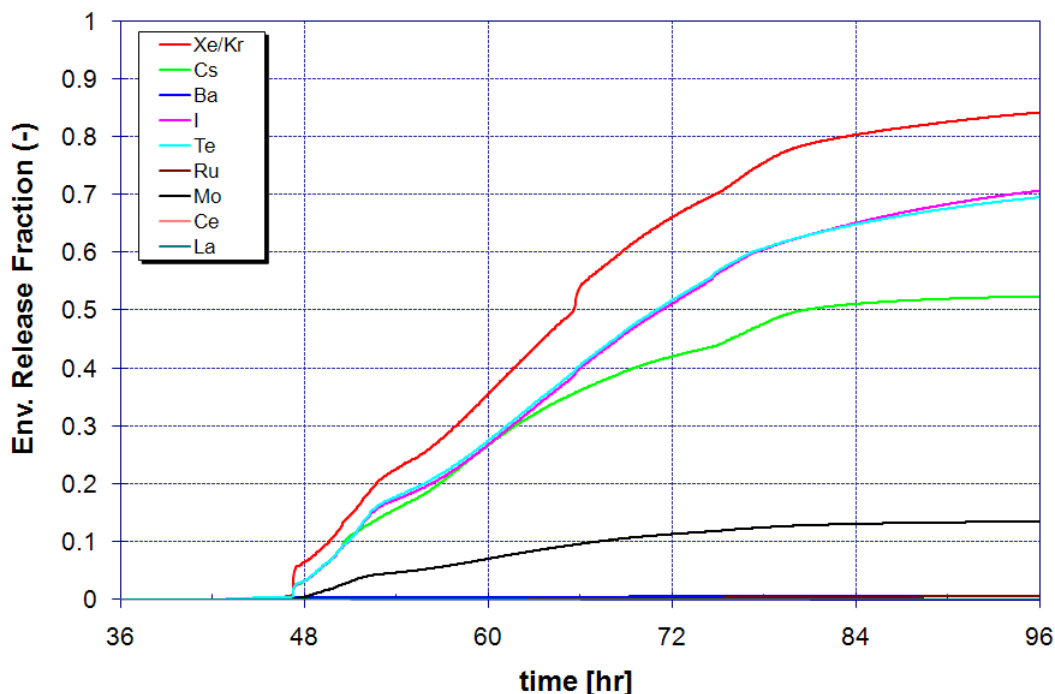
At shorter distances, the change in the land area that exceeds a given dose limit is not significant, while at far distances, the change can be more than a factor of 10. The distance where the amount of land contamination becomes sensitive to different dose criteria is expected to depend on the initial concentration and the deposition rate. For this release magnitude, most of the plume exceeds all of the dose criteria at close distances. However, irrespective of the release magnitude, the affected area will increase and the concentrations will decrease as the plume spreads. Therefore, for all releases, land contamination is more dependent on the dose criteria at far distances.

### 9.8 Sensitivity to Time Truncation (MELCOR/MACCS2)

Project staff judged that a reasonable approach for the project is to consider radionuclide releases only if the fuel has become uncovered by 48 hours and to assume that any potential radiological release is stopped at 72 hours (Section 5.3). However, the use of a time truncation is uncertain, and is capable of significantly affecting the consequences. This assumption could be pessimistic since many resources are available at the State, regional, and national level that could be available to potentially truncate the accident more aggressively. On the other hand, this time truncation could be optimistic, as it assumes that an ongoing spent fuel pool release is capable of being truncated.

Given the uncertainty, this sensitivity considers the effects of both a more aggressive and a less aggressive time truncation. For simplicity, the sensitivity of longer time truncation was based on the weather-average results of a single accident sequence. This is unlike the results of the production analyses, which are frequency-weighted averages of all the release sequences. The sequence chosen was the OCP3 small leak from a high density SFP with unsuccessful deployment of 50.54(hh)(2) equipment, which has a cesium release fraction of 42% at 72 hours. Since the consequence results of individual sequences are not reported, the results of this sensitivity are reported as the fractional increase in consequences over the original results. The sensitivity of a shorter time truncation discusses in which sequences releases would be averted.

A period of 96 hours was chosen to represent a less aggressive time truncation. MELCOR and MACCS2 calculations were extended to 96 hours from the original 72 hours. The effect on the release fractions and the relative effect on offsite consequence can also be seen in the Figure 137 and Table 61 below.



**Figure 137 Atmospheric release fractions for unmitigated high density small leak (OCP3) with a 96 hour time truncation**

**Table 61 Consequence Comparison – Time Truncation Sensitivity**

Time Truncation Sensitivity: 72 Hour vs. 96 Hour (Weather-Averaged; OCP3 Small Leak from high density SFP with unsuccessful deployment of 50.54(hh)(2) equipment)	
Type of Consequence	Conditional* Consequences
	Percent Increase
Individual Latent Cancer Fatality Risk** for 0-10 Miles	38%
Collective Dose (Person-Sv)	27%
Land Interdiction (mi <sup>2</sup> )	28%
Displaced Individuals (Persons)	27%

\* Conditional on a release occurring (frequency of 1E-7 per year, or lower)

\*\* Linear-No Threshold, Population-Weighted

A shorter time truncation, however, can also significantly affect the results. For the sequences involving a small leak from a high density SFP during OCP1 and OCP2 with unsuccessful deployment of 50.54(hh)(2) equipment, fuel uncover occurs around 40 and 43 hours (compared to a baseline time truncation of 48 hours). Using a time truncation less than 40 and 43 hours respectively, would avoid releases for these sequences. In other scenarios, fuel uncover and release occur much sooner than the baseline time truncation.

These results highlight that some releases are expected to be prolonged and therefore a choice in a time truncation can affect offsite consequence predictions.

### **9.9 Sensitivity to Reactor Building Leakage (MELCOR)**

Four sensitivity calculations were performed to examine the impact of the reactor building leakage on hydrogen combustion and accident progression. These covered the small leak scenarios in OCP2 and OCP3 without successful deployment of mitigation. Two larger leak sizes were considered, (1) an increase in the nominal leakage area by a factor of 10, and (2) an increase in the nominal leakage area corresponding to area of a blowout panel. In general, while an increase in area by a factor of 10 increases the leakage, any further increase in area has no effect since the building pressure adjusts to limit the leakage. The leakage area has no significant impact on accident progression, and since the hydrogen is produced over a relatively short time, the hydrogen mole fraction quickly reaches the 10% threshold for ignition. The Cs release fractions are not significantly altered. In OCP2, Cs release fraction is reduced by ~12% while it is increased by ~2% in OCP3 owing to slight variations in the course of the accident.

# 10. ASSESSMENT OF PREVIOUS STUDIES OF SAFETY CONSEQUENCES ASSOCIATED WITH LOADING, TRANSFER, AND LONG-TERM DRY STORAGE

## 10.1 Introduction

Staff has performed an assessment to 1) identify previous studies of safety consequences of spent fuel accidents in both wet and dry storage, 2) determine the extent to which those previous studies are comparable to results from the SFPS, and 3) to the extent practicable, update the results of the previous studies to facilitate a comparative assessment. The SFPS discusses off-site consequences of a spent fuel pool accident in Chapter 7, and provides limited discussion of several similar previous spent fuel pool studies. This Chapter provides a more detailed comparison between off-site consequences calculated for the SFPS and those calculated from previous studies. This Chapter also provides a comparative assessment of SFPS results against previous studies of the safety consequences associated with loading, transfer, and long-term storage in dry cask storage systems (DCSS). In these assessments, staff limited its focus to offsite consequences of accidental releases at commercial nuclear power plants. Specifically, these assessments compare the direct impacts due to offsite radiological exposure and the indirect (e.g., economic or land use) impacts of protective measures taken to avert offsite radiological exposure, of the various studies considered. Offsite impacts from routine operations, doses to workers from routine or accidental exposures, or non-safety related impacts such as costs of spent fuel management, were not considered. Furthermore, staff focused on studies associated with accidents, rather than studies of safety consequences associated with deliberate human actions such as sabotage or terrorism.

## 10.2 Previous Spent Fuel Pool Studies

There have been several previous studies of the consequences of spent fuel pool accidents. These include those in support of Generic Safety Issue 82 and of consequences from spent fuel pool accidents at shutdown nuclear power plants:

- "Severe Accidents in Spent Fuel Pools in Support of Generic Safety Issue 82" (NUREG/CR-4982, 1987)
- "Value/Impact Analyses of Accident Preventive and Mitigative Options for Spent Fuel Pools," (NUREG/CR-5281, 1989)
- "Regulatory Analysis for the Resolution of Generic Issue 82 'Beyond Design Basis Accidents in Spent Fuel Pools'" (NUREG-1353, 1989)
- "A Safety and Regulatory Assessment of Generic BWR and PWR Permanently Shutdown Nuclear Power Plants" (NUREG/CR-6451, 1997)
- "Technical Study of Spent Fuel Pool Accident Risk at Decommissioning Nuclear Power Plants (NUREG-1738, 2001)

The studies conducted to evaluate beyond design basis accidents in spent fuel pools in the late 1980's (NUREG/CR-4982, NUREG/CR-5281, and NUREG-1353) report a variety of impacts related to both radiological doses (e.g., collective doses), as well as the potential impacts associated with limiting radiological doses, such as costs and extent of land condemnation. NUREG-1353 reports collective doses within a 50 mile radius of 8 to 26 million person-rem per event based on MACCS calculations documented in NUREG/CR-5281. It also reports an interdiction area ("*area with such a high level of radiation that it is assumed that it cannot be decontaminated*"), based on CRAC2 calculations from NUREG/CR-4982, of 0 to 244 square

miles (within a 50 mile radius) and offsite property damages of \$3 to \$26 billion in 1983 dollars (also within a 50 mile radius), based on MACCS calculations documented in NUREG/CR-5281. The more recent studies conducted to examine the risks from spent fuel pool accidents at shutdown nuclear power plants (NUREG/CR-6451 and NUREG-1738) also report a variety of both radiological and non-radiological impacts. NUREG-1738 reports radiological impacts of 0 to 200 early fatalities and potential latent cancer fatalities (out to 500 miles) in the hundreds of thousands. These studies used a variety of assumptions regarding pool inventory, release fraction, population density, and emergency response. The results of previous spent fuel pool studies are compared to the SFPS results for various consequence metrics in Table 62.

### **10.2.1 Quantitative Comparison of Spent Fuel Pool Analytical Results**

The following table presents selected consequence results from previous studies of spent fuel pool accidents, and the SFPS.

**Table 62 Comparison of consequence results from current and previous spent fuel pool analyses**

Metric	NUREG/CR-4982, Table 4.7	NUREG/ CR-5281, Table 3.2	NUREG/ CR-6451, Tables 4.1/4.2	NUREG-1738 <sup>1</sup> Tables 3.7-1/3.7-2	SFPS Results <sup>2,3</sup>
Early fatalities (0 to 500 miles)	Not reported	Not reported	0 to 101	0 to 200	0
Individual LCF risk within 10 miles (conditional)	Not reported	Not reported	Not reported	7.7e-4 to 8.2e-2	2.0e-4 to 4.4e-4
Collective dose within 50 miles in Person-Sv	11,000 to 26,000 <sup>6</sup>	80,000 to 256,000	30,000 to 810,000	37,000 to 240,000	7,400 to 39,000
Collective dose within 500 miles in Person-Sv	710,000		40,000 to 3,400,000	450,000 to 600,000	27,000 to 350,000
Interdicted land (square miles)	Not reported	Not reported	Not reported	Not reported	170 to 9,400
Condemned land (square miles)	4 to 224 <sup>4,6,7</sup>	Not reported	1 to 2,800	Not reported	<1 to 83

1. Results presented in Section 3.7 are taken from there; otherwise values are from Appendix 4, Note that the upper end of these values is generally driven by high ruthenium source terms with late evacuation.
2. 0 to 500 mi results are actually 0 to 1000 mi results, which is likely analogous to past study modeling assumptions; uniform pattern results are not included at this time; only LNT results are presented
3. The range of results is not bounding, as it does not represent ranges due to many uncertainties such as weather, operating cycle phase, or pool damage states. Direct consideration of these uncertainties would increase the range, as it likely would for the previous studies as well.
4. Note that the definition of interdicted land is not consistent with the definition used in the SFPS report. The text in NUREG/CR-4982 clarifies that what is reported is permanently uninhabitable land, which is analogous to condemned land.
5. These values use the annualized release frequency, combined with the conditional consequences, thereby over-estimating the average risk.
6. This range is for fire scenarios. For the non-fire scenario, the values were 4 person-rem and 0.0 sq. mi interdiction area.
7. Note that this metric does not change between cases 1A (50 miles) and 1C (500 miles), indicated that there is no additional condemned land beyond 50 miles in this analysis
8. The range at which this metric computed is not specified in NUREG/CR-5281

## 10.2.2 Comparison of SFPS Results to previous Spent Fuel Pool Studies

Comparison of SFPS results to past spent fuel pool studies is not straight-forward, because those studies reported a variety of consequence metrics and used a range of assumptions regarding pool inventory, release fraction, population density, and emergency response. These ranges present a variety of approaches to represent uncertainties from select input parameters, depending on the study. For instance, the range of NUREG-1738 results represents a range due to evacuation times, ruthenium release modeling, time since reactor shutdown, and two competing seismic hazard models. The range of the SFPS, on the other hand, represents a range due to uncertainty in deployment of mitigation equipment and variations of potential pool loading density. In addition, the SFPS results are expected to be sensitive to uncertainties in hydrogen combustion ignition criteria and the time truncation value (and these uncertainties are not reflected in the range of results), as well as uncertainties in weather, decay power, and pool damage states (which are not explicit in the range of results since average results are presented). It is also important to remember that past studies generally used generic assumptions intended to envelope the situation, as opposed to the focus on site-specificity with the SFPS. Nevertheless, these ranges of consequence metrics are often cited by external stakeholders, and thus comparison is informative.

A comparison of the release characteristics from previous spent fuel pool studies demonstrates that releases of cesium are generally less in the current study than in previous studies, and the time from accident initiation to release to the offsite environment is generally longer:

**Table 63 Comparison of Source Terms from Current and Previous SFP analyses**

Resolution of GI-82 (NUREG-1353, NUREG/CR-4982, NUREG/CR-5281):	NUREG-1738	SFPS (preliminary results):
<ul style="list-style-type: none"> <li>• 10 to 100% Cs release (100% assumed for cases 1 and 2)</li> <li>• Release over 8 hours for a propagating SFP zirc fire (assumed)</li> <li>• 0.25 (BWR) or 1.0 (PWR) conditional probability if fuel becomes uncovered</li> </ul>	<ul style="list-style-type: none"> <li>• 75% Cs release (assumed from NUREG-1465)</li> <li>• Instantaneous draindown for large seismic</li> <li>• 2 to 14 hour heatup depending on fuel age (see Table 1A-1)</li> </ul>	<ul style="list-style-type: none"> <li>• Cs release = &lt; 1% to 49%</li> <li>• Draindown to uncover – 2.5 to 43 hours (when leak exists)</li> <li>• Start of release = 8 hours to &gt; 72 hours</li> </ul>

The lack of any early fatalities attributable to acute radiation exposure in this study is consistent with results of some past SFP studies, and much lower than others (e.g., up to 200 early fatalities from NUREG-1738). The range of latent fatalities predicted in this study is consistent with the lower end of the range reported in past SFP studies. The conditional individual latent cancer fatality risk from 0 to 10 miles for the scenarios studied in this report is several orders of magnitude below that reported in NUREG-1738, which was the only other study to report this metric. Even when the early evacuation scenario from NUREG-1738 is used for comparison (average individual risk is in the range of 2.6E-3 to 4.8E-3), the results from the current SFPS study are significantly lower. The collective dose values predicted in this study are consistent with the lower end of the range reported in past SFP studies. The SFPS reports temporarily interdicted land (uninhabitable land during the first year following the postulated accident), in order to remove uncertainty in longer-term effects and policies related to weathering and de-

contamination decisions. Reporting interdicted land makes the results incomparable to the past SFP studies which have presented condemned land. The SFPS does not report other aspects of offsite property damage.

### **10.3 Previous Dry Cask Storage Studies**

The number of studies of the consequences from dry cask handling and storage accidents are more limited than those for spent fuel pools. Safety analysis reports for dry cask storage systems, submitted in support of applications or renewals for site-specific independent spent fuel storage installation (ISFSI) licenses or for DCSS certificates, include some information on offsite consequences of potential accidents (e.g., tornado missile impacts, earthquakes, floods). However, such accidents are generally shown by analysis not to result in a release, and the likelihood of more severe accidents is sufficiently low that the consequences need not be explicitly evaluated. Staff identified one previous NRC analysis on the offsite safety consequences of accidents from dry cask storage systems. The report, "A Pilot Probabilistic Risk Assessment of a Dry Storage System at a Nuclear Power Plant" (NUREG-1864, ML071340012), documents a pilot PRA for a specific dry cask system (Holtec International HI-STORM 100) at a specific boiling-water reactor (BWR) site. The study included an assessment of potential offsite consequences from the drop and failure of a cask. It provides estimates of the annual risk for one cask in terms of the individual probability of a latent cancer fatality within 16 km (10 miles) of the site, and also reports that there are no prompt fatalities. The assessment was performed using MACCS2 for a representative site and is described in detail in Appendix E to NUREG-1864. Site-specific data important to modeling a HI-STORM dry cask 30.5 meter (100-foot) drop accident scenario in the MACCS2 consequence calculation were collected and used. The important parameters/variables required to model the site are the population density/distribution and the site meteorology. The radionuclide inventory, source term (i.e., release fraction, release start time, and release duration), initial plume dimensions (related to the system geometry), and plume heat content were described. Other settings and models necessary for a MACCS2 calculation (e.g., food chain model) were taken from the NUREG-1150 study MACCS2 input file prepared for the Surry Power Station. The input file is documented in Appendix C to the MACCS2 code manual and is referred to there as Sample Problem-A.

#### **10.3.1 Supplemental Analyses**

In order to provide quantitative estimates of safety consequences for accidents during dry cask handling and storage that are directly comparable with the results of the SFPS, and to provide additional output metrics for comparison, staff performed limited MACCS2 supplemental dry cask storage analyses. These supplemental analyses used the source term characteristics from NUREG-1864 coupled with the site-specific characteristics reflected in the MACCS input decks used in the SFPS analyses. The analyses conducted in NUREG-1864 were conducted at a different geographic location than the site selected for the SFPS and evaluated impacts only in terms of selected human health metrics (the individual probability of a prompt fatality within 1.6 km (1 mile) and of latent cancer fatality within 10 miles, and the individual lifetime dose commitment). These metrics can be affected by site-specific characteristics such as meteorology and population distributions surrounding the site. To perform this analysis, staff modified the MACCS input files used for the analyses in the SFPS (described in detail in Chapter 7 of the SFPS) with the revisions discussed below.



Changes related to meteorology, site characteristics, and dosimetry:

No changes were made to the SFPS input deck related to meteorology, site demographic and economic characteristics, or dosimetry. Site data, including weather, population, and land values are therefore consistent with SFPS results. The dosimetry files used are consistent with FGR-13, whereas NUREG-1864 used the dose conversion factors used in NUREG-1150. This is a potential source of difference from the results reported in NUREG-1864.

Changes related to source term and release:

The radiological inventory was changed to be consistent with Table E.1 of NUREG-1864. In addition, a limited set of radionuclides present in the SFPS input deck that are expected to be in secular equilibrium with the nuclides listed in Table E.1 (Ba-137m, Pr-144, and Rh-106) were added with an activity equal to that of their parent radionuclide. However, a limited set of nuclides (Pm-147, Eu-154, Am-242m, Am-243, and Cm-243) reported in NUREG-1864 Table E.1 were not used in the SFPS MACCS2 input deck. Because the dosimetric data for these nuclides was not developed in the SFPS input deck, these radionuclides were not included in the modeled inventory for the supplemental analysis. Based on the much larger inventory of fission products such as Cs-137 and Sr-90, and of actinides such as Pu-241, the omission of these nuclides is not expected to significantly affect the results; however, this is a potential source of difference from the results reported in NUREG-1864. The number of chemical groups was changed to three to represent noble gases (NG), activation products (CRUD) and particulates (PART) to be consistent with the NUREG-1864 source term. Consistent with the NUREG-1864 source term, the only nuclide in the noble gas chemical group was Kr-85, and the only nuclide in the activation product chemical group was Co-60. For consistency with NUREG-1864, all other nuclides were assigned to the particulate group in view of the fact that releases from dry casks are likely to result from impacts at a sufficiently low temperature that radionuclides would be released by mechanical means rather than because of different volatilities. The inventory modeled in this supplemental analysis is provided below:

**Table 64 Modeled Inventory for Supplemental Reanalysis**

Nuclide	Bq	Chemical Group
Co-60	1.61E+14	CRUD
Kr-85	2.77E+15	NG
Sr-90	3.40E+16	PART
Y-90	3.40E+16	PART
Ru-106	2.92E+14	PART
Rh-106	2.92E+14	PART
Cs-134	5.13E+15	PART
Cs-137	5.54E+16	PART
Ba-137m	5.54E+16**	PART
Ce-144	5.08E+13	PART
Pr-144	5.08E+13**	PART
Pm-147	0* (3.37E+15)	PART
Eu-154	0* (4.15E+15)	PART
Pu-238	3.98E+15	PART
Pu-239	1.87E+14	PART
Pu-240	3.47E+14	PART

Pu-241	5.23E+16	PART
Am-241	1.20E+15	PART
Am-242m	0* (1.97E+13)	PART
Am-243	0* (3.07E+13)	PART
Cm-243	0* (3.02E+13)	PART
Cm-244	5.66E+15	PART

\*These nuclides were not included in the supplemental analysis, as discussed above. The values from NUREG-1864 are provided in parentheses to allow comparison of source terms.

\*\*These short-lived progeny were not in Table E.1 of NUREG-1864 but are included in the SFPS input deck. These were included in this table to represent the fact that these are likely to be in secular equilibrium with their parent radionuclides.

The particle size distribution assumed for NUREG-1864 was not identified in Appendix E. For purposes of this supplemental analysis, the particle size distribution for the particulate and activation product chemical group was assigned to be equal to the particle size distribution of the lanthanide chemical group in the SFPS, as lanthanides are presumed to be released due to mechanical measures rather than by volatility. Although this distribution is not the most appropriate for a dry cask storage scenario, using a cask-specific distribution would likely not change the conclusions of this Chapter. Specifically, the larger particle sizes expected to be associated with such a scenario would result in more deposition closer to the site, resulting in fewer exposed individuals within ten miles. The values used are given below:

**Table 65 Particle Size Information**

Particle Size Group	Particle Size Distribution	Dry Deposition Velocity (m/s)
1	3.2%	0.0011
2	15%	0.001
3	29%	0.0014
4	21%	0.0023
6	10%	0.0045
6	3.0%	0.0092
7	1.50%	0.0177
8	0.60%	0.0291
9	0.20%	0.0367
10	16%	0.0367

The release height and release fractions were varied to be consistent with NUREG-1864, Table E.1, as given in Table 66 below. To simulate the short duration release modeled in NUREG-1864, the number of plume segments was reduced to one with release starting at time zero, with a two minute (120 second) release duration. Reflecting the primarily mechanical rather than thermal nature of the release, the plume rise model was changed to a heat only option with a power of 18 kW to be consistent with NUREG-1864. However, parameters associated with building wake effects (e.g., building height, initial plume dimensions) were chosen to be consistent with SFPS values, as these values would be site specific. This represents another potential source of difference with NUREG-1864 values.

#### Changes related to emergency response and long-term protective actions

Consistent with the immediate release model and no evacuation assumption in NUREG-1864,

the supplemental analysis eliminated all evacuating cohorts by changing the evacuation model to “No Evacuation”. However, sheltering and relocation parameters remained consistent with SFPS estimates. No changes were made to SFPS parameters for long-term protective actions such as decontamination levels and costs, as these were selected to be consistent with the SFPS site-specific values to allow for comparability. The application of SFPS emergency-phase sheltering, relocation, and long-term protective action parameters represent a source of difference between the results of NUREG-1864 and the supplemental analysis.

The results, and their comparability to the results provided in NUREG-1864, are provided in Table 66 and Table 67. Results are provided for a range of release fractions and release heights to facilitate comparison with the results reported in NUREG-1864. Staff considers the upper end of the release fraction for particulates in NUREG-1864 (0.12%) to represent a very conservative estimate of the potential respirable particulate release from a breached cask, as it assumes essentially complete fragmentation and entrainment of the high-burnup rim region and very limited filtration (10% released) within the cladding-fuel gap during entrainment flow. Reporting the full range of results, consistent with the results presented in Table E.1 of NUREG-1864, allows a more informed comparison of results including the effects of potential conservatisms in the analyses.

Results are reported for a variety of output metrics. These include both direct measures of health impacts (doses and probabilities of early and latent fatalities) as well as indirect measures such as the amount of land that is either temporarily interdicted or permanently condemned) or the numbers of temporarily or permanently displaced individuals.

**Table 66 Parameters and Results from NUREG-1864, Table E.3**

Release Fraction						
Noble Gases	Particles	CRUD	Release Height (m)	Ind. Risk of Prompt Fatality within 10 mi	Ind. Risk of LCF within 10 mi	Ind. Peak Dose at 1.2-1.6 km (Sv)
0.12	1.2E-03	1.5E-03	50	0	3.6E-04	1.85
0.12	1.2E-04	1.5E-04	50	0	5.2E-05	0.22
0.12	7.0E-06	1.5E-03	50	0	4.3E-06	2.6E-02
0.12	7.0E-07	1.5E-04	50	0	4.3E-07	2.7E-03
0.12	1.2E-03	1.5E-03	120	0	2.1E-04	0.14
0.12	7.0E-06	1.5E-03	120	0	2.6E-06	3.2E-03

**Table 67 Supplemental Reanalysis with SFPS Input Deck**

Release Fraction			Reanalysis with SFPS Input Deck							
NG	PART	CRUD	Release Height (m)	Prompt Fatality within 10 mi	Ind. Risk of LCF within 10 mi	Ind. Peak Dose at 1.2-1.6 km (Sv)	Collective Dose (0-50 mi) Person-Sv	Interdicted land in first year after accident (square miles)	Condemned land (square miles)	Displaced Persons
0.12	1.2E-03	1.5E-03	50	0	7.1E-05	0.33	740	20	1.6E-03	5,800
0.12	1.2E-04	1.5E-04	50	0	8.9E-06	4.0E-02	86	1.4	0	150
0.12	7.E-06	1.5E-03	50	0	7.3E-07	6.6E-03	5.7	1.2E-02	0	1.8
0.12	7.E-07	1.5E-04	50	0	7.5E-08	6.8E-04	0.57	4.1E-06	0	-
0.12	1.2E-03	1.5E-03	120	0	5.1E-05	7.4E-02	780	24	3.9E-05	7,400
0.12	7.E-06	1.5E-03	120	0	7.0E-07	1.7E-03	6.2	3.2E-04	0	0.01

### 10.3.2 Quantitative Comparison of Dry Cask Storage and SFPS Analytical Results

The following table presents selected consequence results from the previous study of dry cask storage accidents, the supplemental dry cask storage study described above, and the SFPS.

**Table 68 Comparison of consequence results from SFPS, NUREG-1864, and DCSS supplemental analyses**

Metric	SFPS Results	NUREG-1864	DCSS Suppl. Analyses
Early fatalities (0 to 500 miles)	0	0	0
Individual LCF risk within 10 miles (conditional)	2.0e-4 to 4.4e-4	4.3e-7 to 3.6e-4	7.5e-8 to 7.1e-5
Collective dose within 50 miles in Person-Sv	7,400 to 39,000	Not reported	0.6 to 780
Collective dose within 500 miles in Person-Sv	27,000 to 350,000	Not reported	Not reported
Interdicted land (square miles)	170 to 9,400	Not reported	<<1 to 24
Condemned land (square miles)	<1 to 83	Not reported	<<1

### 10.3.3 Comparison of SFPS Results to Previous and Supplemental Cask Studies

Comparison of SFPS results to past dry cask studies is not straight-forward. This is because the type of information reported is different, the assumptions related to fuel and canister/cask damage are different, and the risks of dry cask handling, while low, are generally driven by design features that can vary significantly between different DCSS designs. For example, the NUREG-1864 study is based on a welded canister-in-overpack design, whereas the site selected for the SFPS study uses directly loaded bolted casks.

Nevertheless, meaningful comparisons can be made. An examination of the conditional individual latent cancer fatality probability metric demonstrates the effectiveness of emergency response and long-term protective actions at mitigating dose, consistent with the observations made in previous studies such as NUREG/CR-4982 and NUREG/CR-6451. The maximum consequences (in terms of latent cancer fatality probability) for both a pool accident and a dry cask accident, although involving substantially different amount of released material, are both limited to a range of 1E-4 to 1E-3 per event. The contrast to the much higher conditional consequence reported in NUREG-1738 (8.2E-2) is due to the assumption of a late evacuation coupled with a high source term in this study. The difference between impacts from pool and cask accidents is more clearly highlighted in measures related to the areal extent of contamination rather than in measures of peak individual risk. Inspection of Table 67 and Table 68 demonstrates that even in the case of very high release fractions from dry cask accidents, conditional results for metrics such as population dose or condemned or interdicted lands are

several orders of magnitude lower than the low end of consequences of pool accidents. This comparison is significantly exaggerated if a less conservative estimate of the DCSS release fraction is used. The results suggest that a DCSS accident is unlikely to result in the need for extensive offsite protective action such as land interdiction or population displacement, in contrast to a pool accident that may require significant offsite protective action. Furthermore, for the risks (expressed as a frequency-weighted consequence) of a DCSS accident to be comparable to the risks of a pool accident, the frequency of a DCSS accident would have to be several orders of magnitude higher than that of a pool accident.

#### **10.4 Summary of Assessment of Previous Studies**

This assessment demonstrates that past SFP accident consequence estimates from large seismic events are similar to this study for most metrics. Comparison of this study to dry cask storage studies (NUREG-1864 and supplemental analyses from this Chapter), indicates that in some circumstances, the conditional individual LCF risk within 0 to 10 miles would be similar due primarily to the conservative upper bound estimate of the dry cask release as well as the expected effectiveness of protective actions in response to an SFP release. However, conditional results for metrics such as population dose or condemned or interdicted lands are several orders of magnitude lower for dry cask scenarios than the low end of consequences of pool accidents, due to the substantially smaller amount of released material.

## 11. REGULATORY ANALYSIS SCREENING SUMMARY

Based on past studies, the NRC has concluded that both spent fuel pools and dry casks provide adequate protection of public health and safety and the environment, and that the likelihood of an accident involving a radiological release from the spent fuel remains extremely small. While the staff believes that public health and safety is adequately protected for both spent fuel pool and dry cask storage, the Spent Fuel Pool Study (SFPS) provides one part of a technical analysis to confirm, using insights from Fukushima, that spent fuel pools continue to provide adequate protection. As indicated by its title, this study looks at the storage of spent nuclear fuel in spent fuel pools. The study also assesses whether any significant safety benefits (or detriments) would occur from expedited transfer of spent fuel to dry casks, and the potential costs associated with such expedited transfer.

The study establishes that both high and low density spent fuel pool arrangements at the reference plant provide reasonable assurance of adequate protection. The analysis in Appendix D, which is summarized here, assesses the benefits and costs of this action relative to the baseline of existing requirements, including current regulations and relevant orders.

### 11.1 Decision Rationale

#### 11.1.1 Comparison to the Safety Goal Policy Statement

The Safety Goals for the Operation of Nuclear Power Plants: Policy Statement (51 FR 28044) (safety goal policy statement) was used to evaluate the impacts resulting from a severe spent fuel pool accident. The frequency of damage to the spent fuel pool is estimated to be approximately between  $7.11 \times 10^{-7}$  and  $5.39 \times 10^{-6}$  per year when considering all initiators that could challenge spent fuel pool cooling or integrity. This value, when compared to a target core damage frequency value of  $1 \times 10^{-4}$  per reactor-year in the Safety Goal Policy Statement, represents 0.71 to 5.39% percent of the overall frequency of core damage.

As described in Appendix D it is difficult to compare the estimated  $7.11 \times 10^{-7}$  to  $5.39 \times 10^{-6}$  per reactor-year release frequencies for the postulated spent fuel pool accident when considering all initiators to a target value of  $1 \times 10^{-5}$  per reactor year for a large early release frequency (LERF). The spent fuel pool source term is not similar to the core damage (or melt) source term. The consequences of a spent fuel pool accident are predicted to have no early fatalities and public health risk is dominated by latent cancer risks resulting from long-term exposures. Because the analyzed spent fuel accident is a slow progression with at least eight hours before an environmental release occurs and the resultant release is not expected to result in any offsite early fatalities, the analysis suggests that the spent fuel pool release does not fall within the definition of a large early release. Although this analyzed accident is different from a reactor accident, the spent fuel pool estimated release frequencies of  $7.11 \times 10^{-7}$  to  $5.39 \times 10^{-6}$  per reactor-year meet the  $1 \times 10^{-5}$  LERF guidelines.

Collective risk is based on the statistically expected number of early and latent cancer fatalities. The safety goal policy statement defines the early fatality area calculation as that within one mile from the site boundary. A ten-mile radius is defined for calculating latent cancer fatalities. The quantitative objective of the Policy Statement is for the risk to the population in the vicinity of a nuclear power plant from an accident at a nuclear power plant to not exceed 0.1 percent of the sum of cancer fatality risks resulting from all other causes. Based on recent data, the total

fatality rate from cancer in the U.S. is 580,350 per 315,747,500 persons (<http://www.census.gov/popclock/>) or a risk of  $1.84 \times 10^{-3}$  per year, which results in a safety goal of  $1.84 \times 10^{-6}$  per year. Using the bounding frequency of damage to the spent fuel pool of  $5.39 \times 10^{-6}$  per year, which considers all initiators that could challenge spent fuel pool cooling or integrity, and the conditional individual latent cancer fatality risk within a 10-mile radius of  $4.4 \times 10^{-4}$  yields a latent cancer fatality risk of  $2.37 \times 10^{-9}$  per year. This calculated value of  $2.37 \times 10^{-9}$  latent cancer fatalities per reactor-year associated with a spent fuel pool accident represents a 0.13 percent fraction of the  $1.84 \times 10^{-6}$  per year societal risk goal.

Therefore, the risk and consequences of a spent fuel pool accident at the reference plant meet the Safety Goal Policy Statement public health objectives. They also meet the  $1 \times 10^{-5}$  per reactor-year LERF guideline. Therefore, the NRC concludes that a regulatory requirement for expedited transfer of spent fuel from the spent fuel pool to storage casks is not needed for the reference plant in order to meet the Safety Goals.

### 11.1.2 Cost-Benefit Analysis

The key findings of the analysis are as follows:

- **Total Cost to the Reference Plant.** The proposal to expeditiously move older spent fuel assemblies from pool storage to dry cask storage beginning in year 2014 to achieve and maintain a low-density loading in the pool within five years will result in an estimated present value cost of \$46.81 million (using a 7-percent discount rate) and \$42.10 million (using a 3-percent discount rate) over the next 26 years. The earlier upfront and incremental dry storage cask capital and loading costs dominated these incremental costs. The reference plant routine occupational health costs will result in an estimated present value cost of \$27,000 (using a 7 percent discount rate) and \$24,000 (using a 3-percent discount rate). Sensitivity analyses result in an estimated present value cost that ranged from \$16.4 million to \$46.9 million.
- **Value of Benefits to the Reference Plant.** The benefits for expeditious movement of spent fuel to dry cask storage will result in an estimated present value benefit of \$493,000 (using a 7-percent discount rate) and \$711,000 (using a 3-percent discount rate). These benefits result from the monetized value for averted public and occupational radiation exposure and averted onsite impacts and offsite property damage. Sensitivity analyses result in an estimated present value benefit that ranged from \$0.5 million to \$27.7 million.
- **Costs to NRC.** The NRC costs to require the expeditious movement of spent fuel to dry cask storage were conservatively ignored to calculate the maximum potential benefit. Even though the NRC is not expected to incur substantial implementation or annual costs for this alternative, these costs would further reduce the calculated net benefit for the proposed expeditious movement of older spent fuel assemblies from pool storage to dry cask storage for the reference plant.

There are uncertainties in estimating the frequency of events for natural phenomena that are postulated to challenge spent fuel pool cooling or integrity. There are also uncertainties in the calculation of event consequences in terms of the dispersion and disposition of radioactive material into the site environs. This is due in part to uncertainties regarding the degree to which



topographical features and other phenomena are modeled at distances away from the reference plant. Estimating economic consequences also includes large uncertainties, as it is difficult to model the impact of disruptions to many different aspects of local economies and the loss of infrastructure on the general U.S. economy. An example of this is the supply chain disruptions that followed the 2011 Tohoku earthquake and subsequent tsunami in Japan or the 2004 Indian Ocean earthquake and tsunami in Thailand.

The NRC recognizes that there are also costs and risks associated with the handling and movement of spent fuel casks in the reactor building. These impacts, if included in this analysis, would further reduce the overall net benefit in relation to the regulatory baseline. These effects (e.g., the added risks of handling and moving casks) were conservatively ignored in order to calculate the maximum potential benefit by only comparing the safety of high-density fuel pool storage relative to low-density fuel pool storage and its implementation costs without consideration of cask movement risk.

The release of fission products to the environment resulting from other events that cause the loss of spent fuel pool cooling or integrity (i.e., missiles, heavy load drops, loss of cooling or make-up, inadvertent drainage or siphoning and pneumatic seal failures) are estimated to occur approximately once in 2.7 million years or  $3.7 \times 10^{-7}$  per reactor-year. Operator diagnosis and recovery are important factors considered in the development of the event frequencies for these events and portions of this evaluation are premised on licensees having taken appropriate actions to understand the potential consequences of spent fuel pool accident events and develop appropriate procedures and mitigating strategies to respond and mitigate the consequences.

In section 9.2 of the SFPS, a sensitivity analysis is provided in which a more favorable fuel pattern is considered in which eight cold assemblies surround each hot assembly (i.e., 1x8 fuel assembly pattern). Although only a few sensitivity analyses were performed using this configuration, the results looked promising for inhibiting spent fuel pool releases. The sensitivity calculations for the high-density 1x8 fuel pattern showed a shorter time to air coolability (i.e. no releases in OCP3). Even for the cases that led to the release of radioactive materials in OCP2, the release magnitude was much smaller than for the 1x4 fuel pattern, and comparable to the low density cases. The fuel thermal response has a slower heatup when compared to a fuel pattern in which four cold assemblies surround each hot assembly (i.e., 1x4 fuel assembly pattern) because there is more mass to absorb heat. Furthermore, the loading configuration may result in similar reductions in risk to the low-density storage option evaluated without the significant capital costs for implementation. Further evaluation of this alternative and possibly other loading configurations for all operating cycle phases is recommended as part of the regulatory analysis for expedited fuel movement as part of the program plan described in SECY-12-0095 to evaluate the transfer of spent fuel to dry cask storage.

Sensitivity analyses that extend the analyses beyond 50 miles at the reference plant show that the low-density spent fuel storage alternative was not cost-justified for any of the discounted sensitivity cases, and was only marginally justified if discounting was not applied. Therefore, the expedited transfer of spent fuel from pools to dry cask storage containers at the reference plant does not meet the cost-justified substantial safety enhancement criterion.

## **11.2 Further Actions**

The NRC plans to use the insights from this study along with other analyses to inform a broader regulatory analysis, which will help decisionmakers determine whether operating or future

nuclear power reactor licensees should be required to maintain a low-density configuration in their spent fuel pools.

The analysis for the reference plant and the longer-term generic regulatory analysis address the questions of what can go wrong; how likely is it; and what are the consequences. Although this approach is well established at the NRC and other government agencies, it is often difficult to explain following rare disasters such as the accident at Fukushima Dai-ichi, or in presenting the results of studies such as this one. It is not enough to look at only the estimates of the low probabilities for failing spent fuel pools or only at the worst-case consequences in the unlikely event of failures of spent fuel pool integrity and existing mitigating systems. One needs to look at the totality of information presented in this report, previous studies, operating experience, and assess both the potential advantages and disadvantages of regulatory actions regarding the movement of spent fuel from storage pools to dry cask storage containers.

## 12. SUMMARY AND CONCLUSIONS

### 12.1 Summary

This study sought to investigate the relative consequences between low and high-density loading situations for a selected site following a seismic event greater than the maximum earthquake reasonably expected to occur at the reference plant location. The NRC expects that the ground motion used in this study is more challenging for the spent fuel pool structure than that experienced at the Fukushima Daiichi nuclear power plant from the earthquake that occurred off the coast of Japan on March 11, 2011. That earthquake did not result in any spent fuel pool leaks. Chapter 1 discussed some of the considerations that are raised by stakeholders with respect to these differences. These are re-visited here to set the stage for presenting the study's findings.

- Expedited movement of fuel from the SFP to dry storage will decrease the inventory of longer-lived radionuclides such as cesium-137

OCP	High density (MCi)	Low density (MCi)	Ratio (low/high)
OCP1	54	17	0.31
OCP2	59	22	0.37
OCP3	59	22	0.37

- As a result of the above, less radioactive material would be present if a radioactive release occurred, which would be expected to reduce potential health effects, potential land contamination, and economic impacts

This point is covered in the findings below.

- Removal of older fuel slightly reduces the overall heat load in the pool, which can have the effect of delaying the start of a radioactive release (and thus increasing the time available to take mitigative action) for many types of accidents

OCP	High density (kW)	Low density (kW)	Ratio (low/high)
OCP1	2,951	2,526	0.86
OCP2	3,567	3,143	0.88
OCP3	2,571	2,149	0.84

- Removal of older fuel will increase the volume available for cooling water

As mentioned before, this is mathematically a small effect with the older fuel comprising on the order of 5% of the total pool volume (recall that most of the pool is occupied by water, not fuel). In the scenarios studied here, a 5% difference in the initial water inventory generally would not have affected the course of the accident and the offsite consequences.

The results of the study are as follows:

1. A beyond design basis event with a frequency of occurrence of 1 in 60,000 per year was used in this study, and more likely earthquakes are not expected to challenge the SFP structure.

2. Past studies have indicated that large seismic events could lead to the loss of structural integrity of the spent fuel pool liner. This study's results confirm that such a condition is unlikely. For the low probability seismic event described above, the study estimated a conditional probability of failure of 0.1. The specific conditions under which a failure might occur are site-specific.
3. NUREG-1353 (1989) predicted generic seismically-induced SFP liner failure likelihoods of  $2 \times 10^{-6}$  to  $6 \times 10^{-6}$  per year, generally associated with events greater than 0.5g peak ground acceleration. NUREG-1738 (2001) predicted generic seismically-induced SFP liner failure likelihoods of  $2 \times 10^{-7}$  to  $2 \times 10^{-6}$  per year, generally associated with events around 1.2 g. The current study looks at a seismic event in the range of 0.5 to 1 g, and estimates a site-specific SFP liner failure likelihood of  $2 \times 10^{-6}$  per year (based on the informed expectation that this seismic range has the greatest contribution to frequency-weighted consequences). Since the updated *initiating event* frequency estimate (based on the 2008 U.S. Geological Survey model) for the reference plant for events greater than 1 g is  $6 \times 10^{-6}$  per year, this portion of the seismic hazard (i.e., > 1 g) may contribute more significantly to the overall frequency-weighted consequences for the reference plant than previously anticipated, depending on the conditional structural SFP liner failure probability associated with these larger events. The effect of this scope limitation may be offset by potential conservatisms in the structural analysis described in Section 4 of this report.
4. In this study, no set of conditions short of a liner failure led to a radiological release in less than 3 days, which is consistent with past studies. In most cases, the available time to prevent a radiological release was much greater than 3 days.
5. In this study, without mitigative action, fuel is estimated to be air coolable for at least 72 hours for all but roughly 10% of the operating cycle<sup>45</sup>. Past studies estimated this time to be a greater fraction of the operating cycle, when hotter fuel was contiguously stored. In other words, use of the 1x4 pattern has a positive effect in promoting natural circulation air coolability and reducing the likelihood of a release should the SFP become completely drained. An even shorter time was predicted for the 1x8 pattern currently employed at PBAPS. While variability in SFP loading configurations was not a focus of this study, this report consistently shows the advantages associated with dispersed fuel loading patterns.
6. In the cases studied, which in general did not account for multiple or concurrent reactor and SFP accidents, the precise time to diagnose the need for SFP mitigation did not have an effect on the course of most scenarios.

Nevertheless, the improved reliable and available SFP indication required by the NRC Order of March 12, 2012 (EA-12-051) is important to ensure that plant personnel can effectively prioritize emergency actions. The availability of such instrumentation may have changed the mitigation mode (makeup versus sprays) deployed to mitigate events that resulted in a release.

---

<sup>45</sup> The actual time is between 37 days (not air coolable) and 107 days (air coolable), with 60 days representing the demarcation point between these two Operating Cycle Phases. The citation of 60 days as a representative value is reasonable based on other separate effects analyses not documented in this report. The actual time to air coolability could be more or less, depending on specific conditions.

7. This study considered variations in both pool loading and the effective deployment (or lack thereof) of 10 CFR 50.54(hh)(2) mitigation capabilities (i.e., water makeup or spray using portable equipment). Of these, effective deployment of mitigation had the largest impact on preventing a release of radioactive material, reducing the release frequency by a factor of about twenty (from  $1 \times 10^{-7}/\text{yr}$  to  $6 \times 10^{-9}/\text{yr}$ ).

Note that ongoing regulatory actions under Order EA-12-049 dated March 12, 2012 (and related correction dated March 13, 2012) increase the capability of operating nuclear power plants to mitigate beyond-design-basis external events, such as the seismic event studied here.

8. The difference between high-density and low-density loading situations were as follows:
  - In terms of the likelihood of release within 3 days, no difference was seen.
  - In terms of consequences, the low density cases resulted in a smaller release due to the smaller inventory of radioactive material and the lower potential for hydrogen combustion. For high-density loading, the rapid draindown cases in general had smaller releases mainly because the reactor building remained intact (hydrogen combustions not predicted). For slow draindown events, longer times are available for deployment of mitigation. Without successful deployment of mitigation, the releases could be up to two orders of magnitude larger (these cases are associated with hydrogen combustion events).
9. For all scenarios, no offsite early fatalities attributable to acute radiation exposure are predicted to occur. Due to radioactive decay, spent fuel pools tend to have significantly less shorter-lived radionuclides (e.g. I-131) than reactors. Partly because of this, the release is not predicted to be fast and large enough to significantly exceed offsite dose levels necessary to induce early fatalities. . When necessary, emergency response as treated in this study effectively prevents early fatalities from acute radiation exposure.
10. In both high and low density loading without successful deployment of mitigation, the individual latent cancer fatality risk within 10 miles for the studied scenarios is predicted to be on the order of  $10^{-10}$  to  $10^{-11}$  per year, based on the linear no threshold dose response model. While this risk is scenario-specific and related to a single spent fuel pool, it is several orders of magnitude lower than the  $2 \times 10^{-6}$  per year individual latent cancer fatality risk corresponding to the quantitative health objective for latent cancer fatalities and therefore unlikely to contribute significantly to a risk that would challenge the Commission's safety goal policy (NRC 1986). In addition, there is uncertainty in the risk calculations because it is dominated by low doses. As a perspective on uncertainty, excluding the uncertain effects of low doses significantly reduced the quantified individual latent cancer fatality risk within 10 miles. Average individual latent cancer fatality risk is low because of low release frequencies and the expected protective actions.
11. Average individual latent cancer fatality risk is low and decreases slowly as a function of distance from the plant. For scenarios with large releases, significant collective doses are estimated; however, risk of cancer fatalities from these doses would be a small fraction of the risk of cancer fatalities from all causes. Additionally, these individual risks are dominated by long-term exposures to very lightly contaminated areas for which doses are small enough to be considered habitable. In comparing pool configurations,

collective dose (and latent cancer fatalities) for the studied scenarios could be an order of magnitude higher for the high density loading situation as compared to the low density loading situation

12. The amount of land interdiction for the studied scenarios could be up to two orders of magnitude greater for certain high density loading situations as compared to the low density loading situations. Also, like releases in the low density loading situation, successfully deployed mitigation in the high density loading situation is predicted to reduce the amount of land interdiction to a similar extent. For both situations, the major difference is driven by hydrogen combustion events and associated large releases, which are only predicted to occur in scenarios with unsuccessful deployment of mitigation.
13. While the likelihood of release is very low, offsite protective measures in the form of population relocation and land interdiction may be extensive. High-density loading releases without 10 CFR 50.54(hh)(2) mitigation measures are calculated to result in release frequency-weighted land interdiction values of 0.001 mi<sup>2</sup> per year and 0.5 displaced individuals per year which are arrived at by multiplying the estimated frequency and the estimated consequence. While the amount of land interdiction can be large, the fraction expected to be permanently interdicted is small if a release were to occur. For low-density loading or with successful deployment of 10 CFR 50.54(hh)(2) mitigation measures, considerably less land interdiction and displaced individuals are predicted.
14. A comparison of the risks of different fuel handling strategies, such as current practice and expedited transfer, depends on several factors including the relative, site-specific risks, and the time spent in each stage of spent fuel storage. Other risks, such as the risk from cask drop events damaging fuel in the cask or the SFP, may at least partially offset the benefit of lower spent fuel pool risk from low density loading.
15. The human reliability study shows that in most situations SFP mitigation can be deployed in time to prevent release given the assumptions that sufficient plant staff and equipment is available for SFP mitigation and the work area is accessible to perform mitigation. There are two exceptions where mitigation will be ineffective under the moderate leak scenarios: (1) the earthquake occurs at the beginning of a refueling outage when the spent fuel is too hot for the assumed mitigation; and (2) the earthquake occurs when spent fuel is relatively hot and the reactor and spent fuel pool are hydraulically disconnected resulting in insufficient time to deploy mitigation and natural cooling mechanisms cannot prevent fuel damage. This study identified that possible improvements in mitigation flow and nozzle placement in low-dose locations could improve mitigation success likelihood, but this would require further verification.
16. This study demonstrates that past SFP risk estimates from large seismic events are similar to this study for most consequence metrics (see Chapter 10). Comparison of this study to dry cask storage studies (NUREG-1864 and supplemental analyses from Chapter 10) indicates that in some circumstances, the conditional individual LCF risk within 10 miles would be similar due primarily to the conservative upper bound estimate of the dry cask release as well as the expected effectiveness of protective actions in response to an SFP release. However, conditional results for metrics such as temporary or permanently interdicted land or population dose are several orders of magnitude

lower for dry cask scenarios than the low end of consequences of pool accidents, due to the substantially smaller amount of released material.

17. Applying the NRC’s regulatory analysis guidelines to analyse the results of the SFP Study indicates that requiring the low-density spent fuel pool storage alternative is not justified for the reference plant. This conclusion is subject to the analysis model, data, inputs and assumptions in Section D.3 of Appendix D. The risk due to beyond design basis accidents in the spent fuel pool analyzed in this study is sufficiently low that the added costs involved with expediting the movement of spent fuel from the pool to achieve the low-density fuel pool storage alternative are not warranted. Sensitivity analyses that extend the analyses beyond the primary area considered also show that the low-density spent fuel storage alternative was not cost justified for any of the discounted sensitivity cases.

## 12.2 Conclusions

In conclusion, past SFP risk studies have shown that storage of spent fuel in a high-density configuration is safe and risk is low. This study is consistent with earlier research conclusions that spent fuel pools are robust structures that are likely to withstand severe earthquakes without leaking. The study estimated that the likelihood of a radiological release from the spent fuel pool resulting from the selected severe seismic event analyzed in this study is on the order of one time in 10 million years or lower. The factors leading to this low likelihood, as discussed in Section 12.1, are summarized in Figure 138.

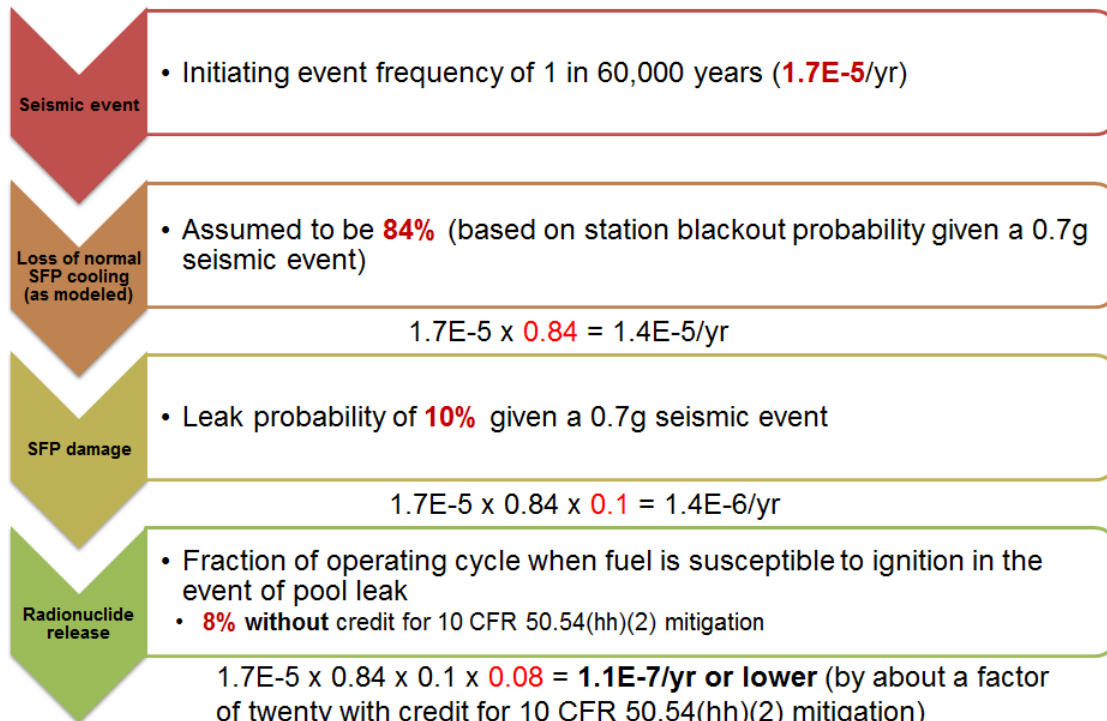
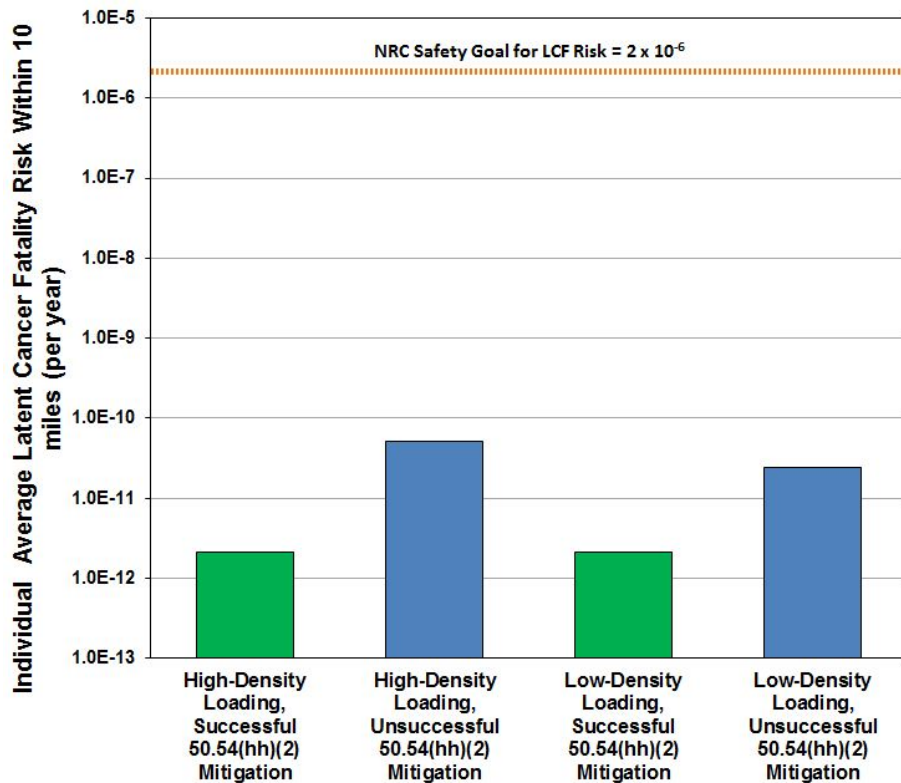


Figure 138: Affecting Likelihood of SFP Release from a Severe Seismic Event

For the hypothetical releases studied, no early fatalities attributable to acute radiation exposure were predicted and individual latent cancer fatality risks are projected to be low, but extensive

protective actions may be needed. Comparisons of the calculated individual latent cancer fatality (LCF) risk within 10 miles to the NRC Safety Goal are provided in Figure 139 to give context that may help the reader to understand the contribution to cancer risks from the accident scenarios that were studied. The NRC Safety Goal for latent cancer fatality risk from nuclear power plant operation (i.e.,  $2 \times 10^{-6}$  or two in one million per year) is set 1,000 times lower than the sum of cancer fatality risks resulting from all other causes (i.e.,  $\sim 2 \times 10^{-3}$  or two in one thousand per year). Comparing the study results to the NRC Safety Goal does involve important limitations. First, the safety goal is intended to encompass all accident scenarios on a nuclear power plant site, including both reactors and spent fuel. This study does not examine all scenarios that would need to be considered in a probabilistic risk assessment for a spent fuel pool, although seismic contributors are considered the most important contributors to spent fuel pool risk. Also, this study represents a mix of limited probabilistic considerations with a deterministic treatment of mitigating features. All analytical techniques, both deterministic and probabilistic, have inherent limitations of scope and method and also have uncertainty of varying degrees and types. As a result, comparison of the scenario-specific calculated individual LCF risk to the NRC Safety Goal is incomplete. However, it is intended to show how multiple spent fuel pool scenarios' risk results in the one in a trillion ( $10^{-12}$  to one in 10 billion ( $10^{-10}$  per year LCF range) are low. While the results of this study are scenario-specific and related to a single spent fuel pool, staff concludes that since these risks are several orders of magnitude smaller than the  $2 \times 10^{-6}$  (two in one million) individual LCF risk that corresponds to the safety goal for latent cancer fatalities, it is unlikely that the results here would contribute significantly to a risk that would challenge the Commission's safety goal policy (NRC, 1986).



**Figure 139: Comparison of Population-Weighted Average Individual Latent Cancer Fatality Risk Results for this Study to the NRC Safety Goal (plotted on logarithmic scale)**



The study results demonstrated that in a high-density loading configuration, a more favorable fuel pattern or successful mitigation generally prevented or reduced the size of potential releases. Low-density loading reduced the size of potential releases but did not affect the likelihood of a release. When a release is predicted to occur, individual early and latent fatality risks for individuals within 10 miles do not vary significantly between the scenarios studied because protective actions, including relocation of the public and land interdiction, were modeled to be effective in limiting exposure. The beneficial effects in the reduction of offsite consequences between a high-density loading scenario and a low-density loading scenario are primarily associated with the reduction in the potential extent of land contamination and associated protective actions.

The results of the SFP Study show that the overall level of safety with respect to spent fuel storage in a spent fuel pool currently achieved at the reference plant is high and that the level of risk at the reference plant is very low. Applying the NRC's regulatory analysis guidelines to analyze the results of the SFP Study with respect to the quantitative benefits attributable to expedited transfer of spent fuel at the reference plant, and the risk reduction attributable to expedited transfer against the NRC's Safety Goals, the NRC concludes the incremental safety (including risk) reduction associated with expedited transfer of spent fuel at the reference plant is not warranted in light of the added costs involved with expediting the movement of spent fuel from the pool to achieve low-density fuel pool storage. Therefore, an NRC requirement mandating expedited transfer of spent fuel from pools to dry cask storage containers at the reference plant does not appear to be justified. The NRC plans to use the insights from this analysis to inform a broader regulatory analysis of the spent fuel pools at US nuclear reactors.

### 13. REFERENCES

- (Alvarez, 2003) Alvarez, Robert, et al., "Reducing the Hazards from Stored Spent Power-Reactor Fuel in the United States," as transmitted in a letter to Ashok C. Thadani dated April 21, 2003. (ADAMS Accession No. ML031130327)
- (AEC, 1963) U.S. Atomic Energy Commission, "Nuclear Reactors and Earthquakes," Reactor Technology Report TID-4500, 22<sup>nd</sup> Edition, Prepared by Holmes and Narver, Inc., August 1963.
- (Ang, 1984) Ang, A.H-S., and Tang, W.H., *Probability Concepts in Engineering Planning and Design: Volume II—Decision, Risk and Reliability*, Wiley, 1984.
- (Ang, 2006) Ang, A. H-S., and Tang, W. H., *Probability Concepts in Engineering: Emphasis on Applications to Civil and Environmental Engineering (v. 1)*, 2<sup>nd</sup> Edition, Wiley, 2006.
- (ANSYS, 2011) Ansys Inc., "ANSYS Mechanical, Release 13," Cannonsburg, PA, 2011.
- (ASCE, 1999) American Society of Civil Engineers, "Seismic Analysis of Safety-Related Nuclear Structures and Commentary," ASCE Standard 4-98, 1999.
- (Bernreuter, 1989) Bernreuter, D.L., Savy, J.B., Mensing, R.W., and Chen, J.C., "Seismic Hazard Characterization of 69 Nuclear Power Plant Sites East of the Rocky Mountains," NUREG/CR-5250, Vols. 1–8, January 1989.
- (Cherry, 1996) Cherry, J. L., "Analyses of Containment Structures with Corrosion Damage," PVP—Vol. 343, "Development, Validation, and Application of Inelastic Methods for Structural Analysis and Design," American Society of Mechanical Engineers, 15–23.
- (Cherry, 2001) Cherry, J. L., and J. A. Smith, "Capacity of Steel and Concrete Containment Vessels with Corrosion Damage," NUREG/CR-6706, Sandia National Laboratories Report SAND2000-1735, February.
- (Congress, 2005) House Report 108-554, Energy and Water Development Appropriations Bill, 2005. Available at [thomas.loc.gov](http://thomas.loc.gov)
- (Durbin, 2005) Durbin, S., "Hydraulic Analysis of the Spent Fuel Pool Experiment," Revision 4, Sandia National Laboratories Internal Memo dated 11/21/05.
- (EPA, 1992) "Manual of Protective Action Guides and Protective Actions for Nuclear Incidents", EPA-400-R-92-001, U.S. Environmental Protection Agency, Washington D.C., May 1992. Available at <http://www.epa.gov/radiation/docs/er/400-r-92-001.pdf>
- (EPA, 1994) "Estimating Radiogenic Cancer Risk", EPA 402-R-93-076, U.S. Environmental Protection Agency, Washington, D.C., 1994.

- (EPA, 2002) Federal Guidance Report No. 13 CD Supplement, Rev. 1, Prepared by Oak Ridge National Laboratory, Oak Ridge, TN for Office of Air and Radiation, U. S. Environmental Protection Agency, Washington, DC., 2002
- (EPRI, 2002) Electric Power Research Institute, "Dry Cask Storage Probabilistic Risk Assessment Scoping Study," EPRI-TR-1003011, 2002.
- (EPRI, 2004) Electric Power Research Institute, "Probabilistic Risk Assessment (PRA) of Bolted Storage Casks: Updated Quantification and Analysis Report," EPRI-TR-1009691, December 2004.
- (EPRI, 2010) Electric Power Research Institute, "Impacts Associated with Transfer of Spent Nuclear Fuel from Spent Fuel Storage Pools to Dry Storage After Five Years of Cooling," EPRI-TR-1021049, November 2010. Available at [www.epri.com](http://www.epri.com)
- (EPRI, 2012) Electric Power Research Institute, "Impacts Associated with Transfer of Spent Nuclear Fuel from Spent Fuel Storage Pools to Dry Storage After Five Years of Cooling, Revision 1," EPRI-TR-1025206, August 2012. Available at [www.epri.com](http://www.epri.com)
- (Exelon, 2011) Exelon Corporation, Letter from Michael Jesse to the U.S. Nuclear Regulatory Commission entitled, "License Amendment Request – Safety Limit Minimum Critical Power Ratio Change," dated June 8, 2011. (ADAMS Accession No. ML111600180)
- (FHWA, 2007) Federal Highway Administration, "Evaluation of LS-DYNA Concrete Material Model 159," Publication Number FHWA-HRT-05-063, McLean, VA, 2007.
- (Gauld, 2011) Gauld, I.C., et al., "Isotopic Depletion and Decay Methods and Analysis Capabilities in SCALE," *Nuclear Technology* **174**, 2, 169, 2011.
- (Gauntt, 2005) Gauntt, R.O., "MELCOR Computer Code Manuals, Vol. 1: Primer and User's Guide, Vol. 2: Reference Manual, Version 1.8.6," NUREG/CR 6119, Nuclear Regulatory Commission, Washington, D.C. 2005.
- (Gauntt, 2010) Gauntt, R.O., "MELCOR 1.8.5 Modeling Aspects of Fission Product Release, Transport and Deposition," Sandia Report, SAND2010-1635, April 2010.
- (Housner, 1963) Housner, G.W., "The Dynamic Behavior of Water Tanks," *Bulletin of the Seismological Society of America*, 53(2):381–387, 1963.
- (ICRP 2008) International Commission on Radiological Protection, "Application of the Commission's Recommendations to the Protection of People Living in Long-term Contaminated Areas after a Nuclear Accident or a Radiation Emergency," *Annals of the ICRP*, Publication 111.

- (Ilas, 2006) Ilas, G. et al., "LWR Cross Section Libraries for ORIGEN-ARP in SCALE 5.1," *Trans. Am. Nucl. Soc.* **95**, 706 2006.
- (Ilas, 2008) Ilas, G. and Gauld, I.C., "SCALE analysis of CLAB decay heat measurements for LWR spent fuel assemblies," *Annals of Nuclear Energy* **35**, 37–48, 2008.
- (INL, 1996) Idaho National Laboratory, "Loss of Spent Fuel Pool Cooling PRA: Model and Results," INEL-96-0334, September 1996.
- (Kanitkar, 2011) Kanitkar, R., Liu, W.W., Houlahan, G., and Kianoush, R., "Water Flow through Crack in Thick Concrete Sections," *Concrete International*, April 2011.
- (Kawamura, 2008) Kawamura, Shinichi, "Investigations and Analyses of The Niigataken Chuestu-oki Earthquake and Kashiwazaki-Kariwa Nuclear Power Station," The Tokyo Electric Power Company, Inc., June 2010.
- (Lambright, 1990) Lambright, J.A., et al., "Analysis of Core Damage Frequency: Peach Bottom, Unit 2 External Events," NUREG/CR-4550, Vol. 4, Rev. 1, Part 3, December 1990.
- (LSTC, 2007) Livermore Software Technology Corporation, "LS-DYNA<sup>®</sup> Keyword User's Manual," Version 971, Livermore, CA, 2007.
- (Malhotra, 2000) Malhotra, P.K., Wenk, T., and Wieland, M., "Simple Procedure for Seismic Analysis of Liquid-Storage Tanks," Structural Engineering International, International Association of Bridges and Structural Engineering, 2000.
- (McGuire, 2001) McGuire, R.K., Silva, W.J., and Costantino, C.J., "Technical Basis for Revision of Regulatory Guidance on Design Ground Motions: Hazard- and Risk-Consistent Ground Motion Spectra Guidelines," NUREG/CR-6728, Prepared by Risk Engineering, Inc., Boulder, CO, October 2001.
- (NAC, 2011) NAC International, "NAC White Paper on Establishing a Balanced Perspective on Wet and Dry Storage of Used Fuel at U.S. Reactors," memorandum to U.S. Nuclear Regulatory Commission dated July 7, 2011.
- (NAS, 2006) National Academy of Sciences, National Research Council, "Safety and Security of Commercial Spent Nuclear Fuel Storage," 2006. Available at [www.nap.edu](http://www.nap.edu)
- (NAS, 1990) *Health Effects of Exposure to Low Levels of Ionizing Radiation: BEIR V.* National Academy of Sciences, National Research Council, National Academy Press: Washington D.C., 1990.
- (Natesan, 2004) Natesan, K. and Soppet, W.K., "Air Oxidation Kinetics for Zr-Based Alloys," NUREG/CR-6846, Argonne National Laboratories, June 2004.

- (NEI, 2006) Nuclear Energy Institute, "B.5.b Phase 2 & 3 Submittal Guideline," NEI-06-12, Revision 2, December 2006. (ADAMS Accession No. ML070090060)
- (NEI, 2011) Nuclear Energy Institute, "Methodology for Performing Aircraft Impact Assessments for New Plant Designs," NEI Report NEI 07-13, Revision 8, April 2011. (ADAMS Accession No. ML111440006)
- (NERH, 2011a) Nuclear Emergency Response Headquarters, Government of Japan, "The Accident at TEPCO's Fukushima Nuclear Power Stations," Report of the Japanese Government to the IAEA Ministerial Conference on Nuclear Safety, June 2011.
- (NERH, 2011b) Nuclear Emergency Response Headquarters, Government of Japan, "The Accident at TEPCO's Fukushima Nuclear Power Stations (Second Report)" Additional Report of the Japanese Government to the IAEA Ministerial Conference on Nuclear Safety, September 2011.
- (NEI, 2012) Nuclear Energy Institute, "Guideline for Assessing Beyond Design Basis Accident Response Staffing and Communications Capabilities," NEI Report NEI 12-01, Revision 0, May 2012. (ADAMS Accession No. ML12110A204).
- (Newmark, 1978) Newmark, N.M. and Hall, W.J., "Development of Criteria for Seismic Review of Selected Nuclear Power Plants," NUREG/CR-009, May 1978.
- (NRC, 1979) U.S. Nuclear Regulatory Commission, "Spent Fuel Heatup Following Loss of Water During Storage," NUREG/CR-0649, March 1979.
- (NRC, 1980a) U.S. Nuclear Regulatory Commission, "Criteria for Preparation and Evaluation of Radiological Emergency Response Plans and Preparedness in Support of Nuclear Power Plants," NUREG/CR-0654/FEMA-Rep1, Rev. 1, November 1980.
- (NRC, 1980b) U.S. Nuclear Regulatory Commission, "Control of Heavy Loads at Nuclear Power Plants," NUREG-0612, July 1980. (ADAMS Accession No. ML070250180)
- (NRC, 1983) U.S. Nuclear Regulatory Commission, "Safety Goals for Nuclear Power Plant Operation," NUREG-0880, Rev. 1, May 1983.
- (NRC, 1986) U.S. Nuclear Regulatory Commission, "Safety Goals for the Operation of Nuclear Power Plants," 51 FR 28044, August 4, 1986 as corrected and republished at 51 FR 30028, August 21, 1986.
- (NRC, 1987) U.S. Nuclear Regulatory Commission, "Severe Accidents in Spent Fuel Pools in Support of Generic Safety Issue 82," NUREG/CR-4982, July 1987.

- (NRC, 1989a) U.S. Nuclear Regulatory Commission, "Value/Impact Analyses of Accident Preventive and Mitigative Options for Spent Fuel Pools," NUREG/CR-5281, March 1989. (ADAMS Accession No. ML071690022)
- (NRC, 1989b) U.S. Nuclear Regulatory Commission, "Regulatory Analysis for the Resolution of Generic Issue 82, "Beyond Design Basis Accidents in Spent Fuel Pools",," NUREG-1353, April 1989. (ADAMS Accession No. ML082330232)
- (NRC, 1990) U.S. Nuclear Regulatory Commission, "Severe Accident Risks: An Assessment for Five U.S. Nuclear Power Plants," NUREG-1150, December 1990. (ADAMS Accession No. ML040140729)
- (NRC, 1995) U.S. Nuclear Regulatory Commission, "Accident Source Terms for Light-Water Nuclear Power Plants," NUREG-1465, February 1995.
- (NRC, 1996) U.S. Nuclear Regulatory Commission, "Generic Environmental Impact Statement for License Renewal of Nuclear Plants," NUREG-1437, May 1996.
- (NRC, 1997a) U.S. Nuclear Regulatory Commission, "Operating Experience Feedback Report: Assessment of Spent Fuel Cooling," NUREG-1275, Volume 12, February 1997. (ADAMS Accession No. ML010670175)
- (NRC, 1997b) U.S. Nuclear Regulatory Commission, Memo from L. Joseph Callan to the Commission entitled "Followup Activities on the Spent Fuel Pool Action Plan," dated September 30, 1997. (ADAMS Accession No. ML003706412)
- (NRC, 1997c) U.S. Nuclear Regulatory Commission, "A Safety and Regulatory Assessment of Generic BWR and PWR Permanently Shutdown Nuclear Power Plants," NUREG/CR-6451, August 1997.
- (NRC, 2001) U.S. Nuclear Regulatory Commission, "Technical Study of Spent Fuel Pool Accident Risk at Decommissioning Nuclear Power Plants," NUREG-1738, February 2001.
- (NRC, 2002a) U.S. Nuclear Regulatory Commission, "Analysis of Spent Fuel Heatup Following Loss of Water in a Spent Fuel Pool: A Users' Manual for the Computer Code SHARP," NUREG/CR-6441, March 2002. (ADAMS Accession No. ML021050336)
- (NRC, 2002b) U.S. Nuclear Regulatory Commission, "Perspectives Gained from the Individual Plant Examination of External Events (IPEEE) Program," NUREG-1742, April 2002.
- (NRC, 2003a) U.S. Nuclear Regulatory Commission, Letter from Ashok Thadani to Robert Alvarez with enclosure entitled, "NRC Review of "Reducing the Hazards from Stored Spent Power Reactor Fuel in the United States," dated August 19, 2003. (ADAMS Accession No. ML031210075)

- (NRC, 2003b) U.S. Nuclear Regulatory Commission, "A Survey of Crane Operating Experience at U.S. Nuclear Power Plants from 1968 through 2002," NUREG-1774, July 2003. (ADAMS Accession No. ML032060160)
- (NRC, 2005a) U.S. Nuclear Regulatory Commission, Letter from Nils Diaz to Pete Domenici with enclosure entitled, "U.S. NRC Report to Congress on the NAS Study on the Safety and Security of Commercial Spent Nuclear Fuel Storage," dated March 14, 2005. (ADAMS Accession No. ML050280428)
- (NRC, 2005b) U.S. Nuclear Regulatory Commission, "Identification and Analysis of Factors Affecting Emergency Evacuations", NUREG/CR-6864, January 2005.
- (NRC, 2005c) U.S. Nuclear Regulatory Commission, "Parametric Evaluation of Seismic Behavior of Freestanding Spent Fuel Dry Cask Storage Systems," NUREG/CR-6865, SAND2004-5794P, February 2005.
- (NRC, 2006a) U.S. Nuclear Regulatory Commission, "Combining Modal Responses and Spatial Components in Seismic Response Analysis," Regulatory Guide 1.92, Office of Nuclear Regulatory Research, Revision 2, July 2006.
- (NRC, 2007) U.S. Nuclear Regulatory Commission, "A Pilot Probabilistic Risk Assessment of a Dry Cask Storage System at a Nuclear Power Plant," NUREG-1864, March 2007. (ADAMS Accession No. ML071340012)
- (NRC, 2008a) U.S. Nuclear Regulatory Commission, "Denial of Two Petitions for Rulemaking Concerning the Environmental Impacts of High-Density Storage of Spent Nuclear Fuel in Spent Fuel Pools (PRM-51-10 and PRM-51-12," SECY-08-0036 dated March 7, 2008 and SRM-SECY-08-0036 dated June 19, 2008. (ADAMS Accession No. ML080170587, ML081710446)
- (NRC, 2008b) U.S. Nuclear Regulatory Commission, "Risk Assessment of Operational Events Handbook," Volume 2, Revision 1.01, January 2008. (ADAMS Accession No. ML080300179)
- (NRC, 2008c) U.S. Nuclear Regulatory Commission, "Review of NUREG-0654, Supplement 3, 'Criteria for Protective Action Recommendations for Severe Accidents' - Focus Group and Telephone Survey," NUREG/CR-6953, October 2008.
- (NRC, 2009) U.S. Nuclear Regulatory Commission, "Generic Environmental Impact Statement for License Renewal of Nuclear Plants, Draft Report for Comment" NUREG-1437 Revision 1, July 2009.
- (NRC, 2010) U.S. Nuclear Regulatory Commission, "Documentation of Evolution of Security Requirements at Commercial Nuclear Power Plants with Respect to Mitigation Measures for Large Fires and Explosions," dated February 4, 2010. (ADAMS Accession No. ML092990438)

- (NRC, 2011a) U.S. Nuclear Regulatory Commission, "Recommendations for Enhancing Reactor Safety in the 21<sup>st</sup> Century: The Near-Term Task Force Review of Insights from the Fukushima Dai-ichi Accident," July 12, 2011. (ADAMS Accession No. ML11186A950)
- (NRC, 2011b) U.S. Nuclear Regulatory Commission, "Virginia Earthquake Frequently Asked Questions," Virginia Quake—NRC Actions. Available at <http://www.nrc.gov/about-nrc/emerg-preparedness/virginia-quake-info.html>.
- (NRC, 2011c) U.S. Nuclear Regulatory Commission, "Options for Proceeding with Future Level 3 Probabilistic Risk Assessment Activities", SECY-11-0089, 2011.
- (NRC, 2012a) U.S. Nuclear Regulatory Commission, Office of Nuclear Regulatory Research, "Generic Issue Management Control System Report for Fiscal Year 2012, 2<sup>nd</sup> Quarter," 2012. Available at <http://www.nrc.gov/reading-rm/doc-collections/generic-issues/quarterly/index.html>.
- (NRC, 2012b) U.S. Nuclear Regulatory Commission, "Central and Eastern United States Seismic Source Characterization for Nuclear Facilities," NUREG-2115; U.S. Department of Energy (DOE) Report, DOE/NE-0140; Electric Power Research Institute Report, EPRI 1021097, 2012. Available at <http://www.ceus-ssc.com>.
- (NRC, 2012c) U.S. Nuclear Regulatory Commission, "Resolution of Generic Safety Issues: Issue 82: Beyond Design Basis Accidents in Spent Fuel Pools (Rev. 3) (NUREG-0933, Main Report with Supplements 1–34)," 2012. Available at <http://www.nrc.gov/reading-rm/doc-collections/nuregs/staff/sr0933/sec3/082r3.html>.
- (NRC, 2012d) U.S. Nuclear Regulatory Commission, "State of the Art Reactor Consequence Analyses (SOARCA) Project: Peach Bottom Integrated Analysis", NUREG/CR-7110, Volume 1, January 2012.
- (NRC, 2012e) U.S. Nuclear Regulatory Commission, "State of the Art Reactor Consequence Analyses (SOARCA) Project: Surry Bottom Integrated Analysis", NUREG/CR-7110, Volume 2, January 2012.
- (NRC, 2012f) U.S. Nuclear Regulatory Commission, "Proposed Orders and Requests for Information in Response to Lessons Learned from Japan's March 11, 2011, Great Tohoku Earthquake and Tsunami," SECY-12-0025, February 17, 2012. (ADAMS Accession No. ML12039A103)
- (NRC, 2012g) U.S. Nuclear Regulatory Commission, NRC Order EA-12-049, "Issuance of Order to Modify Licenses with Regard to Requirements for Mitigation Strategies for Beyond-Design-Basis External Events," dated March 12, 2012, with related correction dated March 13, 2012
- (NRC, 2012h) U.S. Nuclear Regulatory Commission, NRC Order EA-12-051, "Issuance of Order to Modify Licenses with Regard to Reliable Spent Fuel Pool



- Instrumentation," dated March 12, 2012, with related correction dated March 13, 2012
- (NRC, 2012i) U.S. Nuclear Regulatory Commission, "State-of-the-Art Reactor Consequence Analyses (SOARCA) Report," NUREG-1935, November 2012.
- (NRC, 2013) U.S. Nuclear Regulatory Commission, "Synthesis of Distributions Representing Important Non-Site-Specific Parameters in Off-Site Consequence Analyses", NUREG/CR-7161, 2013
- (Paul, 1994) Paul, D.D., et al., "Evaluation and Refinement of Leak Rate Estimation Models," NUREG/CR-5128, June 1994.
- (Petersen, 2008) Petersen, M.D., Frankel, A.D., Harmsen, S.C., Mueller, C.S., Haller, K.M., Wheeler, R.L., Wesson, R.L., Zeng, Y., Boyd, O.S., Perkins, D.M., Luco, N., Field, E.H., Wills, C.J., and Rukstales, K.S., "Documentation for the 2008 Update of the United States National Seismic Hazard Maps," U.S. Geological Survey Open-File Report 2008–1128, 2008.
- (Prassinos, 1989) Prassinos, P.G., et al., "Seismic Failure and Cask Drop Analyses of the Spent Fuel Pools at Two Representative Nuclear Power Plants," NUREG/CR-5176, January 1989.
- (Rearden, 2012) Rearden, B. T., et al. , "Enhancements in SCALE 6.1," PHYSOR 2012 – Advances in Reactor Physics – Linking Research, Industry, and Education, Knoxville, Tennessee, USA, April 15-20, 2012, on CD-ROM, American Nuclear Society, LaGrange Park, IL, 2012.
- (Sato, 2010) Sato, Gatu, "Experience of NCO Earthquake and Restart of Kashiwazaki-Kariwa NPP," *First Kashiwazaki International Symposium on Seismic Safety of Nuclear Installations*, November 2010. Available at <http://www.jnes.go.jp/seismic-symposium10/presentationdata/content.html>.
- (SNL, 1997) Chanin, D. and M.L. Young, *NUREG/CR-6613, SAND97-0594: Code Manual for MACCS2 User's Guide*. 1997, Sandia National Laboratories: Albuquerque, NM.
- (SNL, 2003) Bixler, N.E., et al., *NUREG/ER-6525, Rev. 1, SAND2003-1648P: SECPOP2000: Sector Population, Land Fraction, and Economic Estimation Program*. Sandia National Laboratories: Albuquerque, NM, 2003.
- (SNL, 2005) McFadden, K.L., N.E. Bixler, and R.O. Gauntt, *MELMACCS System Documentation (MELCOR to MACCS2 interface definition)*, Sandia National Laboratories: Albuquerque, NM, 2005.
- (Sobel, 1994) Sobel, P., "Revised Livermore Seismic Hazard Estimates for Sixty-Nine Nuclear Power Plant Sites East of the Rocky Mountains," NUREG-1488, April 1994.

- (Toro, 1989) Toro, G.R., McGuire, R.K., Jacobson, J.P., O'Hara, T.F., Silva, W.J., "Probabilistic Seismic Hazard Evaluations at Nuclear Plant Sites in the Central and Eastern United States: Resolution of the Charleston Earthquake Issue," Electric Power Research Institute Report NP-6395-D, Prepared for the Seismicity Owners Group, April 1989.
- (Wolshon, 2010) Wolshon, B., J. Jones, and F. Walton, "The Evacuation Tail and Its Effect on Evacuation Decision Making", Journal of Emergency Management, January/February 2010, Volume 8, Number 1.

## APPENDIX A: DETAILED EMERGENCY RESPONSE MODELS

The detailed evacuation timing and speeds for each cohort developed using the information and approach described in Section 7.1.4 are described in this appendix. Selected input parameters for WinMACCS are described below:

- Delay to shelter (DLTSHL) represents a delay from the time of the start of the accident until cohorts enter the shelter.
- Delay to evacuation (DLTEVA) represents the length of the sheltering period from the time a cohort enters the shelter until the point at which it begins to evacuate.
- The speed (ESPEED) is assigned for each of the three phases used in WinMACCS, which are the beginning, middle, and late phases. Average evacuation speeds were derived from the reference plant's ETE report. Speed adjustment factors are used in the WinMACCS application to represent free flow in rural areas and congested flow in urban areas.
- Duration of beginning phase (DURBEG) is the duration assigned to the beginning phase of the evacuation and may be assigned uniquely for each cohort.
- Duration of middle phase (DURMID) is the duration assigned to the middle phase of the evacuation and may also be assigned uniquely for each cohort. The remainder of the evacuation, following period defined by DURMID, is the late phase.

### **A.1 Evacuation Model 1: WinMACCS response parameters for sequences where PAGs are not exceeded beyond the EPZ.**

The following cohorts were established for this evacuation model:

0 to 10 Miles, Early Evacuees: This population begins to evacuate before receiving an evacuation order. Focus group work conducted to support NUREG/CR-6953, Volume 2 (NRC, 2008c) suggested that some residents are prepared and ready to evacuate at the first indication of an accident at the nuclear power plant. Results of the telephone survey conducted with NUREG/CR-6953 showed that on a national level, 20 percent of residents of EPZs have packed a "go-bag" and are ready to leave. Because the accident is initiated by a severe earthquake, it is assumed 30 percent of the public evacuate.

10 to 20 Miles, Shadow: These residents evacuate from areas that are not under an official evacuation order. The distribution of the shadow evacuation would likely include a larger percentage of the public near the boundary of the EPZ, and the percent would decrease proportional to the distance away from the EPZ. For this analysis, a uniform fraction of the population is assumed to evacuate within the 10- to 20-mile region. Because the accident is initiated by a severe earthquake, it is assumed 30 percent of the public evacuate. This cohort will begin evacuating as they hear of the evacuation orders and observe EPZ evacuees traveling through the area.

0 to 10 Miles, Public: This population group evacuates over a period of time, with some residents leaving promptly and others leaving later. For this analysis, the bulk of this group is

modeled as a single cohort, while the rest of the group is captured as different cohorts, such as the tail.

0 to 10 Miles, Special Facilities: This is a small but unique population group within the EPZ. There is no delay to shelter because these residents are assumed to be in a robust facility when the accident begins. Specialized vehicles to evacuate these facilities take time to mobilize.

0 to 10 Miles, Tail: The tail represents the last 10 percent of the EPZ population who typically take a longer time to begin to evacuate.

0 to 10 Miles, Schools: This cohort includes elementary, middle, and high school student populations within the EPZ. Schools receive early and direct warning from OROs and have response plans in place to support busing of students out of the EPZ.

Nonevacuating Public: A portion of the public does not follow protective action orders. It is assumed that 0.5 percent of the general public within the EPZ refuse to evacuate.

**Table 69 Evacuation Model 1: EPZ Evacuation**

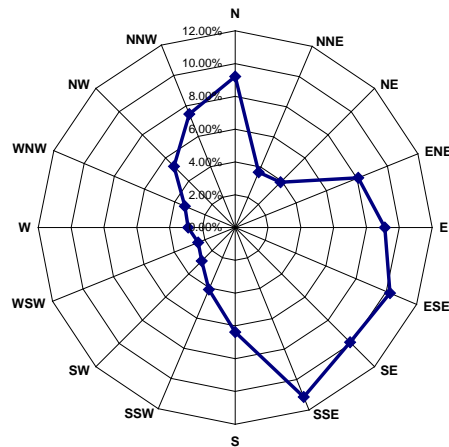
Population		Response Delays (hours)				Phase Duration (hr)		Evacuation Travel Speeds (mph)			
Cohort	Population Fraction	Siren (OALARM)	Delay to Shelter	Delay to Evacuation	Total (Depart time)	Early (DURBEG)	Middle (DURMID)	Early (ESPEED)	Middle (ESPEED)	Late (ESPEED)	
1	0 to 10 miles Early Evacuees	0.3	1	0	0	1	1	0.5	20	15	5
	10 to 20 miles Shadow			2	1	4					
2	0 to 10 miles General Public	0.417	1	1	1	3	0.25	3	5	2	20
3	0 to 10 miles Special Facilities	0.006	1	0	4	5	0.5	0.5	2	15	20
4	0 to 10 miles Evacuation Tail	0.1	1	2	3	6	0.5	0.5	2	15	20
5	0 to 10 miles Schools	0.172	1	0	0.5	1.5	1	0.5	20	15	20
6	0 to 10 miles Nonevacuating Public	0.005	1	-	-	-	-	-	-	-	-

For this sequence, hotspot relocation is 5 rem at 4 hours and normal relocation is 1 rem at 8 hours. The values were established specific for this evacuation model developed for sequences with relatively small releases.

## **A.2 Evacuation Model 2: WinMACCS response parameters for late release sequences where the PAG is exceeded beyond the EPZ.**

Preliminary results suggest that emergency-phase doses of 1 rem may extend 30 to 40 miles from the plant for some of the larger postulated releases. The EPA PAG suggests evacuation to these distances. In this analysis, it is assumed that evacuation to 30 miles is completed and SIP is implemented in the 30- to 40-mile area, which reduces the dose to the public below the PAG.

The population within a 30-mile radius of the reference plant is approximately 1.4 million. The population within the 40-mile radius is approximately 3.4 million. Because of larger populations at longer distances, it is important to better understand the potential directions that the plume would travel. The reference plant's wind rose in the figure below suggests that the predominant wind direction is to the south and east, which is generally toward lower population areas. A secondary direction in terms of likelihood is to the northwest to north. This region is also low in population. Thus, if a release were to occur, it is more likely that a relatively small population would be affected than if the release occurred at a facility near a major city.



**Figure 140 The Reference Plant's Wind Rose**

It is assumed in this evacuation model that ORO's begin to order evacuations beyond the EPZ 24 hours after the start of the accident. This is based on preliminary results that indicates a large release beginning at 48 hours. For this sequence, the population within a 30-mile radius is evacuated after the EPZ has evacuated. The overall evacuation would be implemented as a staged evacuation, which is common for plume-related emergency response. In addition, a SIP is assumed to be ordered for the 30- to 40-mile radius area.

To develop an ETE and corresponding speeds for the areas beyond the EPZ, it was assumed 90 percent of the general public who reside between 10- and 30-miles from the plant can be evacuated 24 hours after ordered to evacuate. This is consistent with the lengthy travel times observed in hurricane evacuations of similar populations. The last 10 percent (evacuation tail) is estimated to take an additional 12 hours. Because of the lengthy time for this release to the atmosphere, this evacuation model effectively includes two separate evacuations, the first being within EPZ followed later by the 10- to 30-mile area.

The following cohorts were established for this evacuation model:

0 to 10 Miles, Schools: This cohort includes elementary, middle, and high school student populations within the EPZ. Schools receive early and direct warning from OROs and have response plans in place to support busing of students out of the EPZ.

0 to 10 Miles, Early Evacuees: This population begins to evacuate before receiving an evacuation order. Focus group work suggested that some residents are prepared and ready to evacuate at the first indication of an accident at the nuclear power plant (NRC, 2008c). Because the accident is initiated by a severe earthquake, it is assumed 30 percent of the public evacuate.

0 to 10 Miles, Public: This population group would evacuate over a period of time, with some residents leaving promptly and others leaving later. For this analysis, the bulk of this group is modeled as a single cohort, while the rest of the group is captured as different cohorts, such as the tail.

10 to 20 Miles, Shadow: These residents evacuate from areas that are not under an official evacuation order. The distribution of the shadow evacuation would likely include a larger percentage of the public near the boundary of the EPZ, and the percent would decrease proportional to the distance away from the EPZ. For this analysis, it is assumed that 30 percent of the general public from the 10 to 20 mile area shadow evacuate. For simplicity, this cohort is assumed to be distributed uniformly over the 10- to 20-mile area. This cohort begins evacuating as they observe EPZ evacuees traveling through the area.

0 to 10 Miles, Special Facilities: This is a small but unique population group within this EPZ. There is no delay to shelter because these residents are assumed to be in a robust facility when the accident begins. Specialized vehicles to evacuate these facilities take time to mobilize.

0 to 10 Miles, Tail: The tail represents the last 10 percent of the EPZ population who typically take a longer time to begin to evacuate.

10 to 30 Miles, Public: This population group evacuates over a period of time, with some residents leaving promptly and others leaving later. For this analysis, the bulk of this group is modeled as a single cohort that enters the roadway network while EPZ evacuees are travelling through. The rest of the group is captured as different cohorts, such as the tail.

10 to 30 Miles, Special Facilities: Special vehicles needed to evacuate these facilities require additional time to mobilize and support the evacuation.

30 to 40 Miles, Shadow: A shadow evacuation may be expected in the area beyond the evacuation area. For this analysis, it is assumed that 20 percent of the general public from the 30- to 40-mile area evacuate. This cohort begins evacuating as they hear the order to evacuate for the 10- to 30-mile area, or observe evacuees traveling through the area.

10 to 30 Miles, Tail: The tail represents the last 10 percent of the population of this area who typically take a longer time to begin to evacuate.

30 to 40 Miles, Shelter in Place (SIP): For this evacuation model, it is assumed that 80 percent of the public remaining after the shadow evacuation complies with the SIP order.

Nonevacuating Public: A small portion of the public does not follow protective action orders. It is assumed that 0.5 percent of the general public within the 0 to 40 mile area refuse to evacuate. This group, however, is subject to relocation and a portion of this cohort is relocated according to the relocation parameters discussed above.

**Table 70 Evacuation Model 2: Evacuation for PAGs exceeded beyond the EPZ (SFP release after 40 hours.)**

Population		Response Delays (hours)			Phase Duration (hr)		Evacuation Travel Speeds (mph)			
Cohort	Population Fraction	Delay to Shelter*	Delay to Evacuation	Total (Depart time)	Early (DURBEG)	Middle (DURMID)	Early (ESPEED)	Middle (ESPEED)	Late (ESPEED)	
1	0 to 10 miles Schools	.172	0.25	1.25	1.5	0.25	2	20	15	20
2	0 to 10 miles Early Evacuees	.2	0.5	0.5	1	1	2	20	10	20
3	0 to 10 miles General Public	.517	1	2	3	0.25	3	5	2	20
4	10 to 20 miles Shadow	.3	2	2	4	0.25	6	20	15	20
5	0 to 10 miles Special Facilities	.006	0	5	5	3	2	2	5	20
6	0 to 10 miles Evacuation Tail	.1	3	3	6	2	2	2	5	20
7	10 to 20 miles General Public	.552	24	4	28	2	18	2	1	20
	20 to 30 miles General Public	.852								
8	10 to 30 miles Special Facilities	.043	15	15	30	1	10	1	1	20
9	30 to 40 miles Shadow	.2	24	8	32	1	6	15	5	20
10	10 to 30 miles Evacuation Tail	.1	24	16	40	10	2	1	10	20
11	30 to 40 miles Shelter in Place	.795	NA	NA	NA	NA	NA	NA	NA	NA
12	0-40 miles Non-evacuating Public	.005	NA	NA	NA	NA	NA	NA	NA	NA

\*Delay to shelter is from the start of the accident (i.e. OALARM set to zero)

For this sequence, hotspot relocation is 5 rem at 4 hours and normal relocation is 1 rem at 16 hours. The releases for these sequences do not begin until about 40 hours or thereafter, and hotspot relocation does not begin until 4 hours after the plume reaches the location. OROs would be able to assemble considerable resources to monitor radiological conditions and could be expected to relocate people relatively rapidly should it be necessary.

### **A.3 Evacuation Model 3: WinMACCS response parameters for early release sequences where the PAG is exceeded beyond the EPZ.**

This evacuation is similar to Evacuation Model 2. Preliminary results suggest that certain sequences that have large releases that begin between 8 and 18 hours and are capable of emergency-phase doses that exceed the PAGs beyond the EPZ. It is expected that dose projections would indicate protective actions beyond the EPZ are necessary. It is assumed that evacuation of the area beyond the EPZ would begin at 10 hours after the start of the accident.

Because the evacuation of the 10- to 30-mile area begins at 10 hours, this response is typical of a staged evacuation that would be employed in the case of a chemical release. The EPZ evacuation impacts the evacuation speeds of the 10- to 30-mile area. The following cohorts were established for this evacuation model:

0 to 10 Miles, Schools: This cohort includes elementary, middle, and high school student populations within the EPZ. Schools receive early and direct warning from OROs and have response plans in place to support busing of students out of the EPZ.

0 to 10 Miles, Early Evacuees: This population begins to evacuate before receiving an evacuation order. Focus group work suggested that some residents are prepared and ready to evacuate at the first indication of an accident at the nuclear power plant (NRC, 2008c). Because the accident is initiated by a severe earthquake, it is assumed 30 percent of the public evacuate.

0 to 10 Miles, Public: This population group would evacuate over a period of time, with some residents leaving promptly and others leaving later. For this analysis, the bulk of this group is modeled as a single cohort, while the rest of the group is captured as different cohorts, such as the tail.

10 to 20 Miles, Shadow: These residents evacuate from areas that are not under an official evacuation order. The distribution of the shadow evacuation would likely include a larger percentage of the public near the boundary of the EPZ, and the percent would decrease proportional to the distance away from the EPZ. For this analysis, it is assumed that 30 percent of the general public from the 10 to 20 mile area shadow evacuate. For simplicity, this cohort is assumed to be distributed uniformly over the 10- to 20-mile area. This cohort begins evacuating as they observe EPZ evacuees traveling through the area.

0 to 10 Miles, Special Facilities: This is a small but unique population group within this EPZ. There is no delay to shelter because these residents are assumed to be in a robust facility when the accident begins. Specialized vehicles to evacuate these facilities take time to mobilize.

0 to 10 Miles, Tail: The tail represents the last 10 percent of the EPZ population who typically take a longer time to begin to evacuate.

10 to 30 Miles, Public: This population group evacuates over a period of time, with some residents leaving promptly and others leaving later. For this analysis, the bulk of this group is modeled as a single cohort that enters the roadway network while EPZ evacuees are travelling through. The rest of the group is captured as different cohorts, such as the tail.

10 to 30 Miles, Special Facilities: Special vehicles needed to evacuate these facilities require additional time to mobilize and support the evacuation.



**30 to 40 Miles, Shadow:** A shadow evacuation may be expected in the area beyond the evacuation area. For this analysis, it is assumed that 20 percent of the general public from the 30- to 40-mile area evacuate. This cohort begins evacuating as they hear the order to evacuate for the 10- to 30-mile area, or observe evacuees traveling through the area.

**10 to 30 Miles, Tail:** The tail represents the last 10 percent of the population of this area who typically take a longer time to begin to evacuate.

**30 to 40 Miles, Shelter in Place (SIP):** For this evacuation model, it is assumed that 80 percent of the public remaining after the shadow evacuation complies with the SIP order.

**Nonevacuating Public:** A small portion of the public does not follow protective action orders. It is assumed that 0.5 percent of the general public within the 0 to 40 mile area refuse to evacuate. This group, however, is subject to relocation and a portion of this cohort is relocated according to the relocation parameters discussed above.

**Table 71 Evacuation Model 3: Evacuation for PAGs exceeded beyond the EPZ (SFP release after 8 hours).**

Population		Response Delays (hours)			Phase Duration (hr)		Evacuation Travel Speeds (mph)			
Cohort	Population Fraction	Delay to Shelter*	Delay to Evacuation	Total (Depart time)	Early (DURBEG)	Middle (DURMID)	Early (ESPEED)	Middle (ESPEED)	Late (ESPEED)	
1	0 to 10 miles Schools	.172	0.25	1.25	1.5	0.25	2	20	15	20
2	0 to 10 miles Early Evacuees	.2	0.5	0.5	1	1	2	20	15	20
3	0 to 10 miles General Public	.517	1	2	3	0.25	3	5	2	20
4	10 to 20 miles Shadow	.3	2	2	4	0.25	6	20	15	20
5	0 to 10 miles Special Facilities	.006	0	5	5	3	2	2	5	20
6	0 to 10 miles Evacuation Tail	.1	3	3	6	2	2	2	5	20
7	10 to 20 miles General Public	.552	6	4	10	2	18	2	1	20
	20 to 30 miles General Public	.852								
8	10 to 30 miles Special Facilities	.043	0	20	20	1	10	1	1	20
9	30 to 40 miles Shadow	.2	6	6	12	1	6	15	5	20
10	10 to 30 miles Evacuation Tail	.1	10	20	30	10	2	1	10	20
11	30 to 40 miles Shelter in Place	.795	NA	NA	NA	NA	NA	NA	NA	NA
12	0-40 miles Non-evacuating Public	.005	NA	NA	NA	NA	NA	NA	NA	NA

\*Delay to shelter is from the start of the accident (i.e. OALARM set to zero)

For this evacuation model, the hotspot relocation is 5 rem at 26 hours and normal relocation is 1 rem at 38 hours. The plume's initial release for these sequences begins between 8 and 18 hours after accident initiation. The assumed inability of the licensee to halt this release is the basis for expecting decision makers to expand the evacuation. Sequences that develop rapidly

could challenge ORO resources to assess radiological conditions beyond the evacuated areas and delay relocation of affected people. In this evacuation model, hotspot relocation does not begin until 26 hours after the release arrives, in order to account for the relatively earlier release and the evacuation of the public from the 10-30 mile area (which is expected to take as long as 24 hours).

# **APPENDIX B: A QUALITATIVE RISK COMPARISON OF SPENT FUEL STORAGE STRATEGIES**

## **B.1 Introduction**

In Staff Requirements Memorandum (SRM) M120607C, dated July 16, 2012, the Commission directed the staff to conduct a comparative assessment of the results of the Spent Fuel Pool Study (SFPS) against previous studies of the safety consequences associated with loading, transfer, and long-term storage in dry cask storage systems (DCSS). Since the SFPS only includes a consequence study of certain seismic events, it is necessary to create a step-by-step model that can be used to compare safety consequences associated with the various stages of onsite spent fuel management. As part of the response to this SRM, this analysis (1) defines several fuel storage strategies to be compared, (2) develops a structure for calculating the difference in risks between these strategies, (3) identifies what relevant information exists, and (4) identifies what new information may be needed.

## **B.2 Spent Fuel Storage Strategies**

For the purpose of studying this issue, two distinct spent fuel storage strategies commonly considered are defined: (1) current practice and (2) expedited transfer of spent fuel into dry storage. A large amount of variation exists in current spent fuel storage practices at various sites. Expedited transfer strategies, if implemented, would also be expected to vary considerably from site to site. Rather than attempting to bound all of the practices that are or may be implemented at various sites, this appendix will focus on the key elements of spent fuel storage strategies covered by existing risk analyses. Current practice generally consists of loading casks only when the pool, in a high density configuration, is nearly full. Just enough casks are loaded to maintain the capability to unload one full core into the pool. Expedited transfer of spent fuel into dry storage involves loading casks at a faster rate for a period of time to achieve a low density configuration in the spent fuel pool (SFP). The expedited process maintains a low density pool by moving all fuel cooled longer than 5 years out of the pool.

## **B.3 Spent Fuel Storage Stages**

The risks associated with spent fuel storage will vary throughout the lifetime of a plant site and will depend on how the fuel is stored, and in what quantities. To analyze the lifecycle risk of spent fuel storage at a plant site, this appendix defines five fuel storage stages, beginning with a low-density pool approaching high density and ending with the final core offload being loaded into casks. The current practice strategy will not include the expedited transfer stage defined below.

Stage 1 consists of the fuel being offloaded into a low-density pool that eventually reaches high density. It is assumed that no casks are loaded during this stage as is generally industry practice. Stage 2 is when the pool is full in a high-density configuration and only as many casks are loaded as necessary. Stage 3 is during the expedited transfer period when the amount of cask loading is increased so as to decrease the inventory in the SFP. Stage 4 begins when expedited loading has been completed and the pool has returned to a low-density configuration and a lower rate of cask loading. Stage 5 begins when the reactor is permanently shut down and the last core is offloaded to the SFP. Stage 5 ends when all fuel has been placed in dry cask storage.

## **B.4 Risk of Spent Fuel Storage**

This section presents generalized equations for the risk of spent fuel storage. These equations will serve as a guide to a subsequent discussion of the relative risk between storage stages and what drives the changes in risk.

The total annual risk of storing spent fuel during any stage can be expressed as the sum of the risk from the SFP and the dry casks. This can be expressed as,

$$R = R_{\text{casks}} + R_{\text{sfp}}$$

where:  $R$  = annual risk of spent fuel  
 $R_{\text{casks}}$  = annual risk of loading and storing fuel in dry casks  
 $R_{\text{sfp}}$  = annual risk of the spent fuel pool

The risk from loading and storing each dry cask is assumed to be constant and only dependent on the number of casks loaded or stored. The total risk of loading and storing casks is given by,

$$R_{\text{casks}} = r_{\text{cask,load}} * N_{\text{load}} + r_{\text{cask,store}} * N_{\text{store}}$$

where:  $r_{\text{cask,load}}$  = risk per cask loaded  
 $N_{\text{load}}$  = number of casks loaded per year  
 $r_{\text{cask,store}}$  = risk per cask in storage  
 $N_{\text{store}}$  = number of casks being stored

Section 1.5 of the SFPS report provides an overview of contributors to SFP risk. The majority of SFP risk is thought to emanate from a loss of water from a leak or a boiloff. The risk from the SFP can then be characterized as the frequency of fuel uncovering multiplied by the consequences of the accident. The uncovering frequency is the sum of the frequency of uncovering from cask drops, seismic events, and other initiators. The frequency of a cask drop damaging the pool and leading to uncovering is the product of the number of casks loaded, the probability of a drop, and the probability of pool damage and uncovering given a drop. This value is given by,

$$R_{\text{sfp}} = (N_{\text{load}} * P_{\text{drop}} * P_{\text{damage}} + F_{\text{seismic}} + F_{\text{other}}) * C_{\text{uncovery}}$$

where:  $P_{\text{drop}}$  = probability of a cask drop per cask loaded  
 $P_{\text{damage}}$  = probability of a dropped cask leading to fuel uncovering  
 $F_{\text{seismic}}$  = frequency of uncovering from seismic events  
 $F_{\text{other}}$  = frequency of uncovering from sources other than cask drops and seismic  
 $C_{\text{uncovery}}$  = consequences of fuel uncovering

The SFPS provided a detailed analysis of the consequences,  $C_{\text{uncovery}}$ , for a particular site and a calculation of  $F_{\text{seismic}}$  for seismic bin 3. To fully calculate  $F_{\text{seismic}}$ , seismic bin 4 would need to be analyzed as well. The SFPS did not analyze other initiators for pool accidents that contribute to SFP risk.

## **B.5 Risk during Each Stage**

Figure 139 is an illustration of the spent fuel risks during each stage for both the current practice and expedited transfer strategies. Though the “current practice” strategy does not include expedited loading, it is divided into the same stages (time periods) for comparison purposes. The figure depicts the SFP risk, dry cask loading risk and dry cask storage risk. The SFP risk includes the risk to the pool from dropped casks.

Figure 141 includes the following major assumptions and limitations:

- The figure is only intended to show trends, not absolute differences in risk. No specific numbers were used to generate the figure.
- The type of risk used will significantly affect the relative values of different portions of the figure. Table 37 gives the ratio of consequences between a high- and low- density pool for several types of risk, with the risk reduction from a low-density pool varying from a factor of 2.1 for individual latent cancer fatality risk for 0–10 miles to 56 for land interdiction.
- The amount of time spent in each stage will affect a calculation of the total risk.
- Changes in  $N_{load}$ ,  $N_{store}$ , and  $C_{uncovery}$  are the drivers for the change in risk between stages. Other terms in the above equations are assumed to be constant.
- The specific shape of the figure will depend on site specific parameters such as the pool’s susceptibility to be drained from a cask drop event ( $P_{damage}$ ).
- Risks are averaged over the operating cycle to demonstrate general trends rather than short-term changes in risk.

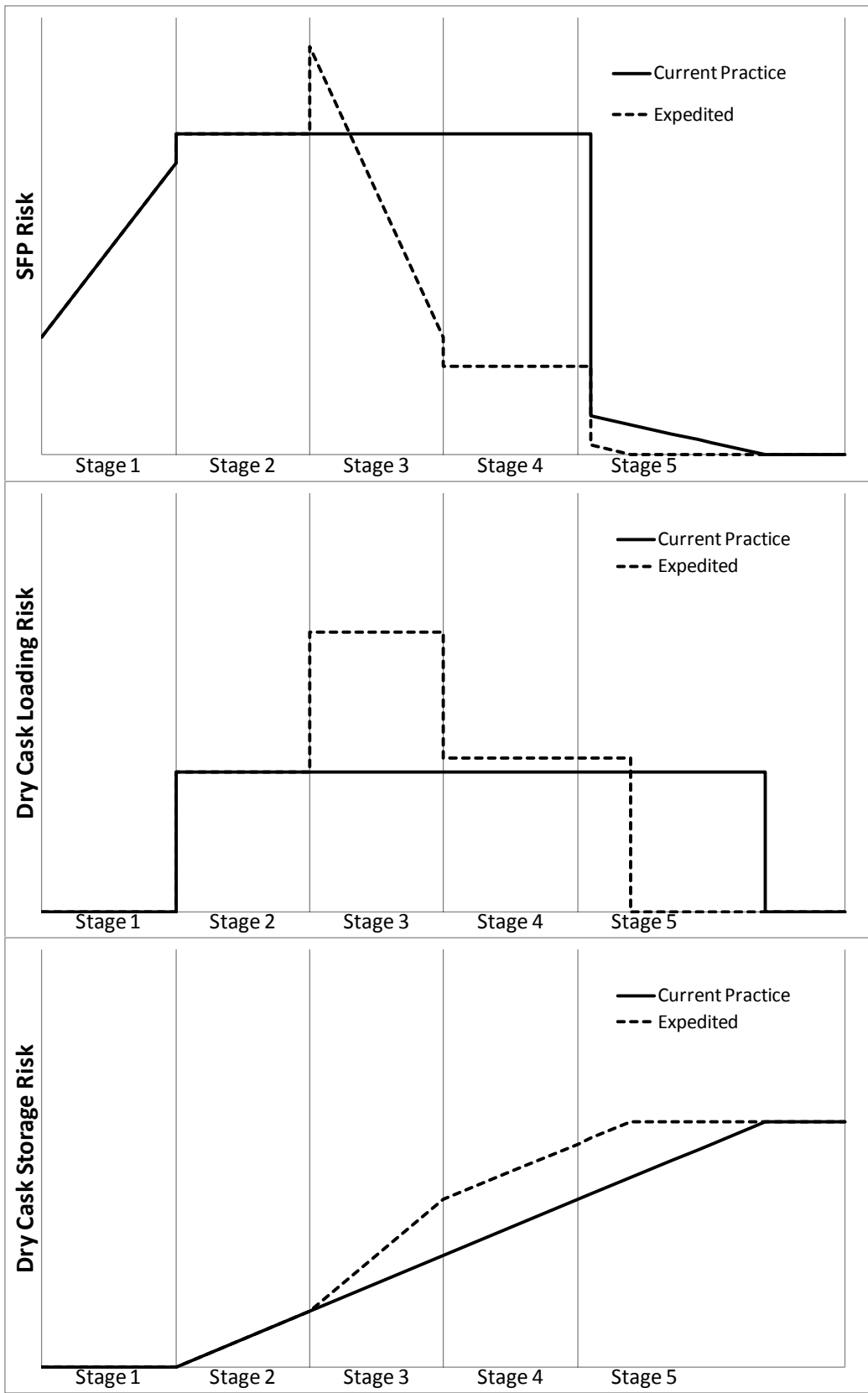


Figure 141 Graphical representation of spent fuel risks

During Stage 1, for both the current practice and expedited transfer scenarios, the amount of spent fuel being stored in the SFP is increasing. As the pool moves from low-density loading to high-density loading, the consequences of fuel uncover,  $C_{\text{uncovery}}$ , and thus SFP risk,  $R_{\text{sfp}}$ , increase. Dry cask loading and storage risk is zero since no casks are loaded during this stage ( $N_{\text{load}}$  and  $N_{\text{store}} = 0$ ).

At the beginning of Stage 2, the pool reaches a high-density configuration and cask loading begins. SFP risk is greater than at the end of Stage 1 because of the possibility of cask drops ( $N_{\text{load}} > 0$ ). It is assumed that the rate of dry cask loading is constant throughout this stage, leading to a constant loading risk and a gradually increasing storage risk as more casks are stored ( $N_{\text{store}}$  is increasing). For the current practice spent fuel storage strategy, the same loading rate is maintained in Stages 2, 3 and 4 and the pool is maintained at maximum loading.

For the expedited transfer strategy, Stage 3 is the beginning of an increased cask loading rate ( $N_{\text{load}}$  increases). The SFP risk undergoes another step increase (from the increased frequency of cask drop events) and then declines as the pool approaches a low-density configuration and the consequence of fuel uncover,  $C_{\text{uncovery}}$ , decreases. Cask loading risk increases as the rate of loading,  $N_{\text{load}}$ , increases. Storage risk increases at a faster rate while more casks are being loaded.

Stage 4 marks the end of the expedited transfer phase when the pool has reached a low-density configuration. The cask loading rate and risk decrease to levels slightly higher than in Stage 2. The hotter fuel being loaded requires more lower capacity casks. The decrease in cask loading rate,  $N_{\text{load}}$ , and consequences of uncover,  $C_{\text{uncovery}}$ , decrease the SFP risk which remains at a constant, lower level for the rest of the stage. Cask storage risk continues increasing at a slower rate.

At the beginning of Stage 5, the reactor ends its final operating cycle and fuel in the reactor core is offloaded to the SFP. After several months, the fuel in the SFP is generally capable of being air cooled, and the risk decreases for both the current practice and expedited transfer strategies. The risk is nonzero because of the possibility of events which may impede air cooling of the fuel. It is assumed that casks continue being loaded at a constant rate until the pool is empty. The SFP risk continues decreasing gradually as the fuel cools and is removed from the pool. When the cask loading is complete, the pool risk and the cask loading risk go to zero, and the cask storage risk stabilizes. The low-density pool in the expedited transfer case contains less fuel and is emptied sooner since much of the fuel was removed in Stage 3.

## **B.6 Total Risk over Time**

Two components compromise the total risk over a period of time, (1) the amount of time spent in each stage and (2) the risk in each stage. The time spent in each stage will vary depending on how soon expedited transfer is initiated (if at all), how long it takes, and how long the reactor continues to operate with a low-density pool. The risks during each stage will depend on the relative hazards at each site.

The recent EPRI report analyzing spent fuel transfer (EPRI, 2012) estimates that expedited transfer for fuel cooled longer than five years would take between 8-15 years at most sites. The amount of fuel in the SFP, whether the site has multiple units sharing a single cask handling crane, and the availability of trained personnel, and equipment affect this estimate. The amount of time then spent in a low-density configuration depends on how much longer the reactor is

operated. It is expected that most reactors will apply for and receive extensions of their operating licenses to 60 years.

The site-specific risks during each stage will drive whether expedited transfer decreases risk, and over what timeframe. An accounting of the risk increases and decreases of expedited transfer compared to current practice will illustrate this point.

For expedited transfer, risk increases relative to current practice are seen in the following stages:

- SFP risk in the beginning of Stage 3 from cask drop events,
- Cask loading risk during Stage 3, and to a lesser extent in Stages 4 and 5,
- Storage risk in Stages 3 and 4 and the beginning of Stage 5

Risk decreases occur in:

- SFP risk later in Stage 3 and in Stage 4,
- cask loading risk in Stage 5

Since the total number of casks loaded is likely to be only slightly higher for the expedited strategy, the increase in cask loading risk during Stage 3 is expected to be mostly offset by the decrease in risk in Stage 5. Furthermore, previous studies such as NUREG-1864, "A Pilot Probabilistic Risk Assessment of a Dry Cask Storage System At a Nuclear Power Plant," issued March 2007, and an EPRI report entitled, "Probabilistic Risk Assessment (PRA) of Bolted Storage Casks," indicate that dry cask storage risk is likely lower than SFP risk. Hence, this leaves a comparison of the increase in SFP risk from cask drops to the decrease in risk from a low-density pool.

The risk increase will depend on the pool's susceptibility to drops (discussed below). For example, if the SFP risk at a particular site were dominated by cask drop risk, it could take many years of operating with a low-density pool to "pay back" the temporary risk increase seen at the beginning of Stage 3. This increase in risk could be mitigated by only loading casks during operating cycle phases 4 or 5 when the SFP is typically air coolable for at least 72 hours, for a complete draindown. In contrast, a pool with low susceptibility to cask drops and high seismic risk will see a greater risk benefit sooner.

One aspect not included in the above figure is the potential need to repackage casks that have already been loaded, before interim storage or permanent disposal. Given the uncertainty in the national strategy for spent fuel, the specifications for disposal at a long-term repository or interim storage site are currently unclear but may be developed in the future. Earlier movement of fuel into current cask designs increases the probability that fuel will have to be repackaged to meet these specifications.

## **B.7 Availability of Information**

The equations defined earlier identify the variables needed to calculate the risk of spent fuel storage. The general shape of Figure 141 is believed to generally apply to operating reactors. However, no analysis has attempted to quantify the horizontal or vertical axes. The discussion below points to existing



information that could be useful in quantifying these variables as well as what further information could be useful.

### **B.7.1 Cask Risks ( $r_{\text{cask,load}}$ and $r_{\text{cask,store}}$ )**

Two major studies have addressed the risk of dry cask loading and storage, NUREG-1864 and EPRI's probabilistic risk assessment of bolted storage casks. NUREG-1864 analyzed a welded cask at a particular boiling-water reactor site. In a complementary effort, the EPRI study analyzed a bolted cask at a generic pressurized-water reactor site. NUREG-1864 identified cask drops and aircraft strikes as the major contributors to risk during cask loading and cask storage, respectively. The EPRI study found the major contributors to risk during cask loading to be drops, failure of the refueling building, and high temperature fires. During storage, major risk contributors were high temperature and forces (e.g., explosions) or heavy loads (e.g., high winds) leading to cask tipover. The difference in major contributors to risk is likely because of differences in the methods used in the analysis as well as differences in the analyzed systems. Regardless, both studies found the risk of dry cask loading and storage to be extremely small. Key factors contributing to this result include the robustness of the analyzed casks and the availability of the refueling building ventilation system, which is capable of significantly decreasing the source term for many accident sequences that result in a cask release.

Several additional factors may affect a calculation of dry cask risk. Considerable uncertainty exists in the source term expected from cask accident sequences resulting in a significant range in consequences, as discussed in Chapter 10. Different cask designs will vary in their ability to resist hazards and may have failure modes not considered in previous studies. Since no standard for performing a dry cask PRA exists, these issues will have to be addressed on a case-by-case basis. The applicability of the assumptions and limitations of previous studies to any future analysis will have to be carefully considered.

### **B.7.2 Number of Casks ( $N_{\text{load}}$ and $N_{\text{store}}$ )**

The number of casks loaded,  $N_{\text{load}}$ , and stored,  $N_{\text{store}}$ , affects the total cask risk,  $R_{\text{cask}}$ . The number of casks loaded also affects the SFP risk,  $R_{\text{sfp}}$ , because of the potential for cask drops. As discussed above, cask loading is assumed to begin in Stage 2, increase during Stage 3 (expedited transfer), and, in Stage 4, return to a lower level necessary to maintain a low-density configuration in the pool.

NUREG-1353 (NRC, 1989a) and the EPRI report on spent fuel transfer (EPRI, 2012) include estimates for the number of casks loaded. NUREG-1353 initially assumes two casks are loaded per week resulting in 104 loads per reactor year. Using assumptions based on more updated information regarding the number of assemblies discharged per reload, the length of the fuel cycle, and the capacity of storage casks in use at the time, the analysis revised this estimate downward by a factor of 10. The EPRI report contains a more detailed analysis considering multi-unit sites and possible expedited loading scenarios. Dependent on these factors, the number of casks loaded annually was estimated to average 3 to 4 annually for current sites and up to 15 to 19 annually for some sites during expedited loading.

At the end of 2011, more than 1,500 casks had been loaded (EPRI). For a comparative risk calculation, site-specific information would have to be collected or estimated. Given the uncertainties in the calculation of risk per cask, and the fact that the risk of loading and storing casks has been estimated to be lower than the risk associated with SFPs, a precise number of casks loaded and stored is not expected to drive the results.

As a first approximation, one might assume that the total number of casks loaded from the SFP would be the same no matter the fuel management strategy. However, expedited fuel transfer requires loading fuel with a higher heat load into casks. Therefore, expedited fuel transfer may result in more casks being loaded with different accident consequences than the current package. The EPRI report estimates the increased number of casks required.

### **B.7.3 Pool Uncovery Frequency from Cask Drop Events ( $N_{load}$ , $P_{drop}$ and $P_{damage}$ )**

Heavy load drops have the potential to damage the SFP, possibly leading to uncovery of the fuel. In general, casks are considered to be the only loads handled over the pool heavy enough to have the potential to cause structural damage. Other heavy loads are usually prevented from traveling directly over the pool.

SFPs can have a variety of configurations affecting their susceptibility to cask drop events. Some pools contain cask loading pits with floors at a higher elevation than the bottom of the pool. Damage from a cask drop event would only drain the pool to a certain level, potentially giving operators sufficient time to align a makeup water source and continue keeping the fuel covered. The cask loading pit may be separated from the pool by a gate. In other pools, casks are loaded directly in the SFPs in a section which may or may not be reinforced to reduce the risk of damage in a cask drop event.

The total frequency of uncovery will be a function of how many casks are loaded, the estimated probability of a drop per loading, and the probability of damage given a drop. Expedited transfer of spent fuel will lead to increased cask loading for a number of years, increasing the risk of a dropped cask damaging the pool. The number of casks loaded is discussed above.

Several studies have addressed the issue of heavy load drops and the anticipated effect on the SFP. NUREG-1353 estimated a drop rate of  $3.1 \times 10^{-4}$  per reactor year assuming two lifts per week without consideration of Generic Safety Issue (GSI) A-36, "Control of Heavy Loads Near Spent Fuel." The reduction in the probability of a cask drop for a plant which complies with the resolution of GSI A-36 was estimated to be a factor of 0.001 for a revised probability of  $3.1 \times 10^{-7}$  per reactor year. A LLNL analysis reported in NUREG/CR-5176 in support of NUREG-1353 considered worst-case cask drops on the pool wall for a boiling-water reactor and a pressurized-water reactor (Prassinis, 1989). The analysis concluded that it is likely that the liner would be severely damaged, so a value of 1 was used for  $P_{damage}$ . Based on updated information, NUREG-1353 judged two lifts per week (104 per year) to be an overestimate by about a factor of 10. The final estimate of the frequency of a cask being dropped and damaging the SFP is  $3.1 \times 10^{-8}$  with an upper bound estimate of  $3.1 \times 10^{-7}$ . This analysis only considered casks dropped on the SFP wall.

NUREG-1738 considered drops that would catastrophically fail the pool, leading to a rapid draindown and failure modes other than drops onto the SFP wall (NRC, 2001). The analysis assumed that only casks are heavy enough to cause catastrophic damage to the pool. Data from NUREG-0612, "Control of Heavy Loads at Nuclear Power Plants: Resolution of Generic Technical Activity A-36," issued July 1980, and NUREG/CR-5176 were combined with a calculation of the fraction of the load path spent over the pool and the fraction of the total path the load is lifted high enough to damage the pool to estimate the probability of a drop that damages the pool. For a nonsingle-failure-proof crane, the drop frequency was estimated, based on NUREG-0612 information, to have a mean value of  $2.1 \times 10^{-5}$  per year (using 100 lifts per year). For single-failure-proof cranes or plants that conform to the NUREG-0612 guidelines,

the drop frequency was estimated to have a mean value of  $2 \times 10^{-7}$  per year (for 100 lifts per year). The analysis assumed that licensees with a non-single-failure-proof crane took appropriate mitigative actions to reduce the expected frequency of catastrophic damage to the same range as for facilities with a single-failure-proof crane.

NUREG-1864 used empirical drop data reported in NUREG-1774, "A Survey of Crane Operating Experience at U.S. Nuclear Power Plants from 1968 through 2002," issued July 2003, to estimate the probability of dropping a cask. Three load drop events were identified from an estimated 54,000 lifts in the 1968–2002 time period, giving a probability of  $5.6 \times 10^{-5}$  per lift. This probability was considered conservative given that, of the three events, only one was a freefall while the other two were uncontrolled descents. The probability of pool damage was not estimated.

The EPRI dry cask PRA constructed a fault tree of a crane to address a range of factors and to account for specific crane features. Data from NUREG-0612 and other sources were used to estimate failure probabilities for basic components as well as human error probabilities. The final probability of a cask drop given a lift was estimated to be  $5.3 \times 10^{-6}$ . The probability of pool damage was not estimated.

Data cataloguing the susceptibility of SFPs to cask drops for the reactor fleet is not readily available. To address this issue, a risk analysis would need to either perform a site-specific analysis of cask drops, or conservatively assume that most (if not all) drops will damage the pool.

#### **B.7.4 Pool Uncovery Frequency from Seismic Events ( $F_{\text{seismic}}$ )**

The frequency of seismic events damaging the pool liner and leading to fuel uncovery depends on both the seismic hazard (i.e., the frequency of the initiating event) and the fragility of the SFP (i.e., the probability that the liner fails given that the event occurs). Chapter 3 of the SFPS report discusses the availability of seismic hazard information.

In contrast, seismic fragility data has not been characterized for most SFPs. NUREG/CR-5176 used a fragility analysis approach involving seismic loads derived from floor response spectra for the reactor building based on design response spectra. These loads were then combined with analytical methods for the calculation of the fundamental period of vibration of SFP floors and walls, as well as approximate methods for the calculation of the strength of these floors and walls. The approach used to derive the SFP fragility was generally consistent with methods used for seismic margin assessments at the time of that study. Since NUREG-1738 was not a site-specific analysis, an attempt was made to generalize this information. NUREG-1738 convolved a generic fragility (roughly corresponding to the fragilities calculated in NUREG/CR-5176) with EPRI and LLNL seismic hazard estimates to estimate the seismic risk. The study also developed a screening checklist such that a plant passing the checklist would have confidence of having a pool fragility of at least the assumed amount.

Finally, the SFPS performed a detailed analysis for the reference plant employing a combination of the approach used in NUREG/CR-5176 to estimate seismic loads with finite element analyses of the SFP structure to calculate hydrodynamic impulsive loads, nonlinear response mechanisms and strain concentrations in the liner. Chapter 4 of the SFPS report describes the structural analysis and estimated SFP performance. Chapter 10 provides a comparative assessment of the estimated performance for the SFP considered in the study with the

performance of SFPs in recent major earthquakes in Japan including the SFPs at the Fukushima Daiichi nuclear power plant under the Tohoku earthquake of March 11, 2011.

The most robust way to estimate the seismic risk would be to utilize existing hazard estimates, and perform a site-specific fragility analysis. For some analyses, particularly those considering multiple sites, this may be time and cost prohibitive since the staff and licensees do not generally have fragility analyses of the pools. A generalized analysis for all plant sites would have to address the uncertainty in the variation of SFP responses to seismic events. One approach would be to use a conservative fragility estimate and to develop a checklist to ensure that the estimate is appropriate for the pools being considered.

#### **B.7.5 Pool Uncovery Frequency from Other Events ( $F_{\text{other}}$ )**

As discussed in Section 1.5 of the SFPS report, the majority of SFP risk is believed to emanate from pool leakage events such as cask drops and seismic events discussed above, as well as events that preclude water injection for a long period of time (e.g. days). Table 1 in the SFPS report shows the frequency of fuel uncovery from various contributors calculated in NUREG-1353 and NUREG-1738.

#### **B.7.6 Pool Consequences ( $C_{\text{uncovery}}$ )**

The SFPS is the most detailed analysis to date of SFP consequences. As discussed in the SFPS report, the study was performed for a specific site for a specific initiating event. However, the consequence results will largely hold for other initiating events and may offer insights applicable to other sites. When applying the consequence results to one or several other sites, the assumptions used in the study, discussed in Chapter 2 of this report, must be considered along with which factors drove the results, discussed in Chapter 10 of this report. Some of these drivers and how they are expected to vary between plants are discussed below.

Once fuel in the pool has become uncovered, it may still be coolable from natural circulation of air, depending on the amount of decay heat and the amount of cooling. In the SFPS, the fuel is estimated to not be air coolable for 10 percent of the operating cycle. Factors affecting this include the amount of fuel in the pool, its configuration, burnup, geometry of the fuel racks, etc. A partial draindown event with channeled fuel could impede airflow and increase the time to coolability.

A significant driver of the amount of radioactivity released is whether a hydrogen combustion event occurs. The SFPS results predict these events in some high density loading situations, but not in any low density loading scenarios. It's not clear whether this result will hold true for other reactor sites and what level of pool loading is sufficient to achieve this result. Furthermore, the SFPS did not consider hydrogen events from hydrogen originating from a concurrent reactor accident.

The consequence metric used will significantly affect the outcome of any comparative risk calculation. Comparisons of results using different consequence metrics are seen in Table 38 of the SFPS for high-density versus low-density fuel loading and are discussed in Chapter 10 for previous SFP and dry cask risk studies. These results demonstrate that the individual latent cancer fatality risk metric is relatively insensitive to changes in release magnitude for spent fuel accidents. Other metrics, such as land contamination, are much more affected by the amount of radioactivity released. Specific reasons for this are discussed in more detail in Sections 7.6 and Chapter 10.

Other site-specific factors that may affect the consequences of pool uncover include SFP inventory, mitigative measures, and the surrounding population density and land value. The SFPS analysis for these aspects may have varying levels of applicability to other sites.

### **B.7.7 Other Spent Fuel Risk Considerations**

Several additional events are not believed to significantly contribute to spent fuel risk. Dropping a single assembly is not expected to challenge the integrity of the pool, but may release some radiation. NUREG-1864 analyzes this event. Criticality events, which NUREG-1353 assumes not to be an issue, are considered in Section 3.6 of NUREG-1738. Although this report does not explicitly evaluate criticality events, Section 2.3 does discuss them.

### **B.8 Conclusions**

This appendix discusses some of the information needed to perform a risk comparison of spent fuel storage strategies. NUREGs 1353, 1738 and 1864 provide much of the information for certain plants, and could be supplemented by the site-specific analyses described in the SFPS report. A complete comparison depends on several factors, including the relative, site-specific risks, and the time spent in each stage of fuel storage. The benefit of lower SFP risk from low density loading may be offset by increases in other risks, such as the risk from cask drop events damaging fuel in the cask or the SFP. However, the magnitude of that offset has not been completely calculated for any single plant. Additional work would be necessary to evaluate the applicability of existing information to a particular site or a group of sites.

## APPENDIX C: COMMISSION AND ACRS CORRESPONDENCE

Letter from the Advisory Committee on Reactor Safeguards on April 25<sup>th</sup> 2012 (ADAMS Accession No. ML1208A216): In this letter the ACRS describes the results of a meeting between the Advisory Committee on Reactor Safeguards and the Office of Nuclear Regulatory Research, to the NRC Chairman.



**UNITED STATES  
NUCLEAR REGULATORY COMMISSION  
ADVISORY COMMITTEE ON REACTOR SAFEGUARDS  
WASHINGTON, DC 20555 - 0001**

April 25, 2012

The Honorable Gregory B. Jaczko  
Chairman  
U.S. Nuclear Regulatory Commission  
Washington, DC 20555-0001

SUBJECT: SPENT FUEL POOL SCOPING STUDY

Dear Chairman Jaczko:

During the 593<sup>rd</sup> meeting of the Advisory Committee on Reactor Safeguards, April 12-14, 2012, we reviewed the methods and approaches being used in the Office of Nuclear Regulatory Research (RES) Spent Fuel Pool Scoping Study (SFPSS). Our Materials, Metallurgy, and Reactor Fuels and Reliability and PRA Subcommittees jointly reviewed the methods and approaches as well as preliminary results of this study on March 6, 2012. During these meetings, we had the benefit of discussions with representatives of the NRC staff. We also had the benefit of the documents referenced.

### CONCLUSIONS

1. The SFPSS is being performed in an organized and systematic manner, and is using modern NRC codes to evaluate the change in consequences from seismically induced spent fuel pool accidents with high and low-density loading.
2. The SFPSS consists of a detailed deterministic analysis of the consequences of a severe seismic event on a spent fuel pool at a single boiling water reactor (BWR) site.
3. The study will contribute to the technical basis for making decisions regarding expedited transfer of older irradiated spent nuclear fuel (SNF) from spent fuel pools.

### BACKGROUND

The SFPSS was initiated in July 2011 and is planned for completion by June 2012. The staff was tasked with developing updated information on key aspects of potential spent fuel pool accident consequences on an aggressive one year schedule. The staff was directed to move expeditiously in a technically rigorous manner, using modern codes and methods.

To accomplish this task, the staff reviewed past consequence and risk assessments related to SNF storage, as well as other reports of relevance that have been developed by other organizations. The staff identified seismic hazard as the logical starting point to assess the continued applicability of past studies and to develop insights for the SFPSS. Depending on the results gained from the SPFSS, additional work may be appropriate to reach generally applicable conclusions for the U.S. BWR and pressurized water reactor (PWR) fleet.

Along with providing general updates to past information within the current operational and regulatory environment, the staff indicated that for the scenarios investigated, the study can address key questions and provide insights, such as:

- Do accident progression timelines for SNF pools proceed more slowly than previously thought?
- Do seismically induced station blackout scenarios contribute significantly to the overall consequences, or are these consequences dominated by seismically induced pool drain down?
- Do low-density loadings in spent fuel pools produce substantially different results in terms of public health effects and offsite consequences compared to high-density loadings?
- Do successful post event mitigation actions substantially reduce offsite consequences?

The staff indicated that answers to these questions are expected to be helpful in determining whether expedited transfers of SNF from pools to dry cask storage systems (DCSS) produce substantial safety benefits, thereby informing future regulatory decision making. Other ongoing efforts, such as planned Level 3 probabilistic risk analyses, will complement and build on this work.

#### **DISCUSSION**

The technical approach selected by the staff is focused on a detailed analysis of the spent fuel pool in a General Electric BWR-4 reactor at a single site during five phases of an operating cycle. Two conditions in the pool are considered: one representative of the current high-density loading in a relatively full SNF pool, and another representative of low-density loading in which older SNF has been removed to a dry cask storage facility. The elements of the study will include:

- seismic and structural assessments of the integrity of the pool and liner following seismic events with up to six times greater peak ground acceleration than the design basis safe shutdown earthquake (SSE) for the examined site;
- analysis of reactor building dose rates using the SCALE code package;

- accident progression analyses of fuel damage, fission product release, benefits of mitigation, and other effects using the MELCOR code modified to handle spent fuel pool accidents;
- emergency planning assessment;
- offsite consequences analyses of health effects and land contamination using the MACCS2 code; and
- probabilistic considerations.

The approach taken by the staff is capable of producing useful assessments of the consequences of severe seismic events on the structural integrity of the selected spent fuel pool design. The study is also capable of producing quantitative assessments of the safety benefits of low density fuel pool loading on the extent of fuel damage, land contamination, and off site health effects. However, since the study will not address the safety consequences of the same severe seismic events on cask loading, transportation, or long-term storage; the overall safety benefit will not be quantified. The possibility that there could be negative safety consequences associated the expedited loading, transfer, and long-term storage of possibly thousands of DCSS would need to be considered.

For the reasons noted above, the conclusions of the study may not be broadly applicable to the variety of reactor and pool designs in operation in the United States.

We look forward to a future review of the results and conclusions of the SFPSS.

Additional comments by ACRS Members J. Sam Armijo, Michael T. Ryan, Stephen P. Schultz, and Gordon R. Skillman are presented below.

Sincerely,

/RA/

J. Sam Armijo  
Chairman



**Additional Comments by ACRS Members J. Sam Armijo, Michael T. Ryan, Stephen P. Schultz, and Gordon R. Skillman**

The staff's approach is rightly focused on the effects of severe seismic events on the structural integrity of U.S. spent fuel pools. Absent a failure of the pool structure and liner, there can be no rapid or uncontrollable draining of the pool, overheating and failure of the fuel cladding, release of radioactive fission products, and exposure to workers and the public. In the absence of pool failure and drain down, fuel cooling will be maintained in either the high density or low density loading scenarios to be studied in the SFPSS.

In view of the importance of pool structural integrity following seismic events, the SFPSS should be broadened to consider the performance of the spent fuel pools at the Fukushima Daiichi, Fukushima Daini, Onagawa, and Tokai sites following the severe Tohoku earthquake of March 2011, as well as the performance of the spent fuel pools at the Kashiwazaki-Kariwa site following the severe Chuetsu earthquake of July 2007. None of these pools suffered structural failure or drain down. The demonstrated robustness of the spent fuel pools at Fukushima Daiichi was noteworthy. These pools were subjected to the initial M9 earthquake, followed by several aftershocks greater than M7, and hundreds of lesser magnitude. In addition, the potentially weakened spent fuel pools in Units 1, 3 and 4 survived further structural loading from hydrogen explosions without significant damage or draining of the pool water. Although limited in scope, inspection of the fuel and sampling of the spent fuel pool water in the badly damaged Unit 4 revealed that the fuel had not suffered significant damage. By any reasonable standard, the performance of spent fuel pools protected the fuel from significant damage.

Since the spent fuel pools at Fukushima Daiichi were of the same design and vintage as the design chosen for the SFPSS, this broader approach could provide valuable data to confirm or correct the findings of the study.

**REFERENCES**

1. Technical Study of Spent Fuel Pool Accident Risk at Decommissioning Nuclear Power Plants, NUREG-1738, February 2001(ML010430066)
2. RES Memorandum, Subject: Project Plan for Spent Fuel Pool Scoping Study, July 26, 2011 (ML111570370)

Letter from the NRC Staff (ML12137A271): Letter was to the ACRS Chairman, Dr. J. Sam Armijo in response to his earlier letter to the Commission.

May 23, 2012

Dr. J. Sam Armijo, Chairman  
Advisory Committee on Reactor Safeguards  
U.S. Nuclear Regulatory Commission  
Washington, DC 20555-0001

SUBJECT: RESPONSE TO THE ADVISORY COMMITTEE ON REACTOR SAFEGUARDS  
LETTER, DATED APRIL 25, 2012, ON THE SPENT FUEL POOL SCOPING  
STUDY

Dear Dr. Armijo:

I am responding to your letter of April 25, 2012, in which you provided the comments of the Advisory Committee on Reactor Safeguards (ACRS) on the staff's Spent Fuel Pool Scoping Study that was presented to the ACRS on April 12–14, 2012.

The staff agrees with ACRS' summary of the limitations of the study. The study results and the limitations will be considered with other factors when the staff evaluates the Fukushima Lessons Learned Tier 3 issue of whether spent fuel should be transferred to dry cask storage earlier than currently planned by the nuclear power plant licensees. As summarized in your letter, such factors include, but are not limited to, the risks of additional fuel handling when loading and transferring the spent fuel to the casks. The staff will also consider the relevant operating experience related to the integrity of spent fuel pools subjected to severe seismic events.

We appreciate the comments on the staff's plans for the study and look forward to further interactions on this topic.

Sincerely,

*/RA Michael F. Weber for/*

R. W. Borchardt  
Executive Director  
for Operations

cc: Chairman Jaczko  
Commissioner Svinicki  
Commissioner Apostolakis  
Commissioner Magwood  
Commissioner Ostendorff  
SECY

Staff Requirements Memo of July 16th 2012 (ADAMS Accession No. ML121980043): SRM directing staff to include additional scope to the Spent Fuel Pool Scoping Study report.

July 16, 2012

**ML121980043**

IN RESPONSE, PLEASE  
REFER TO: M120607C

MEMORANDUM TO: Edwin M. Hackett, Executive Director  
Advisory Committee on Reactor Safeguards

R. W. Borchardt  
Executive Director for Operations

FROM: Andrew L. Bates, Acting Secretary */RA/*

SUBJECT: STAFF REQUIREMENTS – MEETING WITH THE ADVISORY  
COMMITTEE ON REACTOR SAFEGUARDS, 9:30 A.M.,  
THURSDAY, JUNE 7, 2012, COMMISSIONERS' CONFERENCE  
ROOM, ONE WHITE FLINT NORTH, ROCKVILLE, MARYLAND  
(OPEN TO PUBLIC ATTENDANCE)

The Commission met with the Advisory Committee on Reactor Safeguards (ACRS) to discuss the Committee's recent accomplishments and its ongoing and future activities. The ACRS presented updates on the following specific issues: 1. Spent Fuel Pool Scoping Study (SFPSS), 2. Implementation of Fukushima Recommendations, 3. State-of-the-Art Reactor Consequences Analyses (SOARCA), and 4. NRC Research Program.

As the ACRS noted in its April 25, 2012, letter on the SFPSS and reiterated during its meeting with the Commission, "since the study will not address the safety consequences of the same severe seismic events on cask loading, transportation, or long-term storage, the overall safety benefit will not be quantified. The possibility that there could be negative safety consequences associated with the expedited loading, transfer, and long-term storage of possibly thousands of DCSS [dry cask storage systems] would need to be considered."

The Office of Nuclear Regulatory Research should conduct a comparative assessment of SFPSS results against previous studies of safety consequences associated with loading, transfer, and long-term dry storage. These previous studies should be updated as necessary to conduct the comparative assessment.

The staff should also conduct a human reliability analysis focused on the capability to implement effective spent fuel pool cooling mitigating strategies, such as those required by 10 CFR 50.54(hh) or the recently issued Order EA-12-49, "Mitigation Strategies for Beyond-Design-Basis External Events."

In addition, the SFPSS should consider the evidence from the performance of the spent fuel pools during the real incidents identified in the additional comments by ACRS members in the April 25, 2012, letter.

The results of the SFPSS and the comparative assessment should be provided to the ACRS for its review, and subsequently provided to the Office of Nuclear Reactor Regulation for use in disposition of the Near-Term Task Force Tier 3 item on spent fuel storage, and sent to the Commission as an information paper after the staff has addressed the ACRS's comments.

cc: Chairman Macfarlane  
Commissioner Svinicki  
Commissioner Apostolakis  
Commissioner Magwood  
Commissioner Ostendorff  
OGC  
CFO  
OCA  
OIG  
OPA  
Office Directors, Regions, ASLBP (via E-Mail)  
PDR

ACRS letter to Honorable Allison M. Macfarlane, NRC Chairman, from J. Sam Armijo, ACRS Chairman, dated July 18, 2013 (ADAMS Accession No. ML13198A433).



**UNITED STATES  
NUCLEAR REGULATORY COMMISSION  
ADVISORY COMMITTEE ON REACTOR SAFEGUARDS  
WASHINGTON, DC 20555 - 0001**

July 18, 2013

The Honorable Allison M. Macfarlane  
Chairman  
U.S. Nuclear Regulatory Commission  
Washington, DC 20555-0001

**SUBJECT: SPENT FUEL POOL STUDY**

Dear Chairman Macfarlane:

During the 606<sup>th</sup> meeting of the Advisory Committee on Reactor Safeguards, July 9-12, 2013, we reviewed the NRC staff's report, "Consequence Study of a Beyond-Design-Basis Earthquake Affecting the Spent Fuel Pool for a U.S. Mark I Boiling Water Reactor." This study is commonly referred to as the Spent Fuel Pool Study (SFPS). Our Materials, Metallurgy, and Reactor Fuels and Reliability and PRA Subcommittees jointly reviewed the methods, approaches, and findings of this study on May 8, 2013. During these meetings we had the benefit of discussions with representatives of the NRC staff. We also had the benefit of the documents referenced.

**CONCLUSIONS AND RECOMMENDATIONS**

1. The SFPS has been performed in a thorough and systematic manner, and provides a state-of-the-practice assessment of the consequences of a beyond-design-basis seismic event on the spent fuel pool in a reference boiling water reactor containing either high-density or low-density fuel loading.
2. The study has demonstrated that health effects from seismically initiated spent fuel pool damage scenarios are very low for both low-density and high-density pool loadings.
3. We agree with the staff's conclusion that expedited transfer of spent fuel from the pool to dry cask storage does not provide a substantial safety enhancement for the reference plant.
4. An important insight from the SFPS is that the less conventional (1x8) high-density fuel loading configuration actually used in the reference plant can significantly reduce the consequences of seismically induced damage. This approach should be further explored as a measure to provide additional defense in depth against spent fuel pool accidents.

5. The SFPS provides sound approaches, tools, and insights for a broader evaluation of the consequences of severe seismic events on spent fuel pools of different design and will be valuable in determining whether expedited transfers to dry cask storage systems (DCSSs) produce substantial safety benefit for U.S. BWRs and PWRs.
6. The SPFS should be issued.

## BACKGROUND

One of the early NRC concerns following the March 11, 2011 Great East Japan Earthquake and tsunami was the possibility that the spent fuel pools at Fukushima had been severely damaged and drained, that fuel cladding had failed due to overheating, and could be releasing very large amounts of radioactive material. This early concern was not unreasonable in view of the unexpected detonation at Unit 4 in which all the fuel was in the spent fuel pool. Within a short time it became clear that the spent fuel pools at Fukushima were not damaged or leaking, the fuel cladding was undamaged, and uncontrolled radiological releases had not occurred. Despite these observations, concerns remained that spent fuel in the pools constituted a major threat to public health and safety. As a result, expedited transfer of spent fuel from the pools in U.S. reactors to DCSSs has been proposed.

The primary objective of the SFPS was to determine the safety benefit of expedited transfer of spent fuel from the pool of a reference BWR (of similar design to those at Fukushima) to DCSSs. The staff reviewed past consequence and risk assessments related to spent fuel storage. These studies showed that risk of fuel uncover was low, but that the consequences could be large. These prior studies also showed that seismic hazard was the dominant contributor to spent fuel pool risk. For these reasons, the staff selected a study of the consequences of a beyond-design-basis seismic event at a General Electric BWR-4 Mark I reference plant as the starting point to assess the continued applicability of past studies and to evaluate the safety benefit of low-density versus high-density fuel loading in spent fuel pools. Depending on the results gained from the study, it was recognized that additional work would be needed to reach generally applicable conclusions for U.S. BWRs and PWRs.

In a Staff Requirements Memorandum (SRM), dated July 16, 2012, the Commission directed the staff to incorporate human reliability analysis (HRA) and conduct a comparative assessment of the results of the SFPS with previous studies of the safety consequences associated with loading, transfer, and long-term storage in DCSSs. In addition, the SRM stated that the SFPS should consider comparisons of the performance of spent fuel pools during the real incidents identified by the ACRS members in the April 25, 2012, letter with the predicted behavior of the reference spent fuel pool.

## DISCUSSION

The SFPS is a detailed analysis of the consequences of a severe, beyond-design-basis, seismic event on the spent fuel pool in a BWR-4 Mark 1 reference plant at a specific site. The analysis was intended to be as realistic as possible with minimal deliberate additions of conservatism. The study examines the benefits of 10 CFR 50.54(hh)(2) mitigation procedures and equipment required by the Power Reactor Security Rulemaking, although it does not consider the capabilities associated with the FLEX program or the requirements of Orders EA-12-051 and EA-12-049.

### Seismic and Structural Analyses

The seismic initiator selected for the study was an event with a peak ground acceleration (PGA) range of 0.5 to 1.0 g, a geometric mean PGA of 0.7 g, and a likelihood (based on PGA) of 1 in 60,000 years. The staff concluded that this event provided a good compromise between events with higher occurrence frequencies that would lead to little or no damage versus higher consequence events with very low frequencies. This selection was consistent with prior spent fuel pool probabilistic risk analyses and similar to the seismic event chosen for the State-of-the-Art Reactor Consequences Analysis short-term station blackout study. The event is considerably more severe than the current design basis Safe Shutdown Earthquake (SSE) of the reference plant (PGA of 0.12 g) and the SSEs of most U.S. plants. The horizontal response spectrum is the Generic Issue-199 spectral shape, which used the 2008 U.S. Geological Survey model, scaled to a PGA of about 0.7 g.

Structural modeling and analyses were performed to determine the damage states that would be produced by the reference seismic event and to define the initial conditions for the damage progression analysis. Cracking of the reinforced concrete pool and tearing of its stainless steel liner at the bottom of the pool had the greatest potential for creating leaks and potentially draining the pool, but other damage states were not ignored. The study included quantitative assessments of: the amount of water lost by sloshing, damage to the refueling gate, damage to support systems and penetrations, damage to the reactor building, and damage to other relevant structures. Qualitative assessments were also made of damage to spent fuel racks and stored fuel assemblies.

In-structure response spectra (ISRS) at elevations of interest were obtained by scaling the ISRS developed for the reference plant for the NUREG-1150 study. The loads on the spent fuel pool structure included the static weight of concrete, steel, water, storage racks, and fuel; the dynamic forces from the ground motion; and hydrodynamic forces from the water in the pool. These loads and best-estimate mechanical properties of all pool materials including concrete, structural steel, and the liner were used as inputs to a three dimensional nonlinear finite element analysis of the pool structure and its supports to determine the extent of cracking of the concrete and deformation or tearing of the liner.

The integrity of the spent fuel pool liner is the most important factor influencing the rate and extent of damage following the seismic event. To address liner integrity, the staff constructed a detailed finite element model of the reference plant liner, including floor and wall attachments, using elements as small as 0.15 inches. This model was integrated into the concrete base model to calculate the strains in the liner. The maximum liner strains were concentrated at the attachments to the backup plates embedded in the concrete. These maximum strains however were less than the expected failure strain for the liner material. The staff performed an analysis which considered variability in the failure strain, uncertainties in the ISRS accelerations, uncertainties in concrete properties, and reductions in spectral accelerations to account for ground motion incoherency and nonlinear effects.

The results of these analyses confirmed that a state with no liner tearing was most likely with a relative likelihood in excess of 90%. For the state in which there was a 10% likelihood of liner tearing, the staff assumed that there was an equal likelihood that tearing of the liner would result in small leaks or moderate leaks. The staff estimated the average flow rate for a small leak to a height of about 16 ft above the spent fuel pool floor is about 200 gallons per minute. Their estimate of the average flow rate for the moderate leak to a height of about 16 ft above the spent fuel pool floor is about 1,500 gallons per minute.

The analyses of the likelihood of liner tearing and the resulting flow rates are subject to considerable uncertainty associated with the characteristics of the cracking in the concrete, the loading on the structure, the initial condition of the liner and the concrete, the prediction of failure in the liner material under complex stress states, and the leak rates through cracks in concrete and steel.

The staff believes that this assessment is somewhat conservative. We concur with this assessment. The impact of such uncertainties should be considered in the context of the overall behavior of the system. Caution should be exercised in extrapolating the fragility results from the analysis of this particular spent fuel pool to other pool configurations.

The results of the seismic and structural analysis can be described in terms of three initial damage states which are used as inputs to follow-on analyses of accident progression:

- A state with no leakage. In this state, the liner would be intact, but through-wall cracking of the concrete would occur at the junction of floor and wall of the pool. The likelihood of this state was determined to be 90%.
- A state with small leakage. In this state the rate of leakage would be controlled by the number and dimensions of localized tears in the liner. The likelihood of this state was assumed to be 5%. Absent any mitigation, the pool would drain completely in approximately 42-62 hours.
- A state with moderate leakage. In this state the liner would be severely damaged and the rate of leakage would be controlled solely by the dimension of cracks in the concrete. The likelihood of this state was assumed to be 5%. Absent any mitigation, the pool would drain completely in approximately 6-9 hours.



### Accident Progression Analyses and Radiological Releases

Detailed analyses of accident progression were performed using the MELCOR code. Various models within the code were used to evaluate major factors affecting accident progression. These included the pool geometry, fuel design, fuel loading configurations, rack design, decay heat, radionuclide inventory, thermal radiation, air oxidation, hydraulic resistance, fission product release and transport, and the effects of mitigative sprays.

To address the varying heat load and fission product content of the spent fuel pool, the plant operating cycle, was divided into five operating cycle phases (OCPs):

- OCPs 1 and 2 include the refueling period during which the spent fuel pool is connected to the reactor, and the decay heat generation rate is at its highest. These phases account for 3% of the plant operating cycle.
- OCP 3 is a post outage phase in which the spent fuel pool is no longer connected to the reactor, and decay heat is decreasing but still high. This phase represents 5% of the plant operating cycle.
- OCPs 4 and 5 cover the remaining 92% of the plant operating cycle during which decay heat is slowly decreasing. A 1x4 configuration (one recently discharged assembly surrounded by four low power assemblies) was used throughout the study for the high-density pool loading cases, although the reference plant uses a more favorable 1x8 configuration.

For each OCP, the staff analyzed scenarios in which combinations of damage state (no leak, small leak, or moderate leak) mitigation (effective or ineffective) and fuel loading (high-density or low-density) were evaluated. The analyses showed:

- No radiological release occurred for the most likely, no-leak, damage state even with high-density fuel loading. Coolant losses due to seismic induced sloshing and boil-off were small. Even during OCP 1 the fuel remained covered with 15 feet of water after 72 hours.
- For the small leak damage state, no releases occurred for any operating cycle phase for mitigated high-density or low-density fuel loading scenarios. This was not the case for unmitigated, high-density or low-density loadings during OCPs 1, 2 and 3. For these scenarios timely deployment of 10 CFR 50.54(hh)(2) spent fuel pool makeup was required to prevent release. If left unmitigated, radiological release would begin within 40 to 60 hours of the seismic event.

- A significant advantage of the low-density loading was that hydrogen deflagrations were not predicted for any of the small leak unmitigated cases, whereas deflagrations and substantially higher releases were predicted for unmitigated high-density pool loading using the 1x4 configuration. In separate sensitivity analyses the staff evaluated the 1x8 high-density configuration actually used by the reference plant and found that this configuration resulted in major reductions in heat-up rates and maximum fuel temperatures, no deflagrations, and no radiological releases. Such loadings should be evaluated further to determine whether they are broadly beneficial to BWR and PWR spent fuel pools.
- For the moderate leak damage state, mitigation was effective in preventing release during OCPs 2 and 3 for both high-density and low-density fuel loading but not effective during the first week of the plant operating cycle (OCP 1).
- For the moderate leak damage state, mitigation was not necessary to prevent release during OCPs 4 and 5. Both high-density and low-density fuel loadings were air-coolable.

#### Mitigation and Human Reliability Analyses

For scenarios in which mitigation is successful, the study credited the use of 10 CFR 50.54(hh)(2) equipment and the use of both on-site capabilities and off-site resources to extend the utilization of this equipment until on-site capabilities are recovered. None of these capabilities were credited in the assessment of unmitigated scenarios.

The SFPS shows that the 10 CFR 50.54(hh)(2) equipment is capable of mitigating most scenarios. However, such equipment may not be available due to deployment for other purposes. Order EA-12-049, while not evaluated in the SFPS, specifically requires a capability to maintain spent fuel pool cooling. Responses to the order should be evaluated to ensure that they provide the capability to deal with leakage on the order of that expected in a beyond-design-basis seismic event such as that considered in the SFPS.

To gain insights into the likelihood that successful mitigation could be accomplished, the staff performed a simplified HRA. Unfortunately the analysis does not address complexities expected to affect human performance during a severe seismic event, and it does not account for the effects of uncertainties. Therefore, the calculated human error probabilities are optimistic and cannot be considered as realistic estimates of the probability of success. Nevertheless, the descriptive analysis of the actions required to implement mitigation provides a useful structure for understanding these activities.

### Offsite Consequence Analyses

The SFPS shows that for all scenarios no early fatalities are predicted to occur. Even in the unmitigated scenarios, the predicted releases are neither fast enough nor large enough to significantly exceed offsite dose levels that can cause early fatalities. As modeled in the SFPS, personnel evacuation and hotspot relocation are always effective in preventing significant exposure to all individuals in the areas of most concern. A more thorough consideration of uncertainties could identify cases where evacuations are not as effective.

The SFPS also shows that average individual latent cancer fatality risk based on the linear no threshold dose response model is low for both high and low-density loadings without successful mitigation. These individual risks are dominated by long-term exposures to contaminated areas for which doses are small enough to be considered habitable. Use of alternate dose models results in significant reduction in the individual latent cancer fatality risk estimates.

The amount of land interdiction for the studied scenarios could be up to two orders of magnitude greater for the high-density loading configuration compared to the low-density loading configuration. However, successfully deployed mitigation in the high-density loading configuration is predicted to reduce the amount of land interdiction.

Overall, the SFPS provides a technically sound basis for the staff's conclusion that expedited transfer of spent fuel from the pool to dry cask storage does not provide a substantial safety enhancement for the reference plant. The study also provides approaches, tools, and insights for a broader evaluation of the consequences of severe seismic events on spent fuel pools of different design, and will be valuable in determining whether expedited transfers to DCSSs produce substantial safety benefit for U.S. BWRs and PWRs. We commend the staff for these accomplishments.

Sincerely,

*/RA/*

J. Sam Armijo  
Chairman

### REFERENCES

1. Consequence Study of a Beyond-Design-Basis Earthquake Affecting the Spent Fuel Pool for a U.S. Mark I Boiling Water Reactor, June, 2013 (ML13133A132)
2. ACRS Letter, Subject: Report on the Spent Fuel Pool Scoping Study, April 25, 2012 (ML12108A216)
3. Staff Requirements: M120607C, July 16 2012 (ML121980043)
4. U.S. Nuclear Regulatory Commission, "Severe Accident Risks: An Assessment for Five U.S. Nuclear Power Plants," NUREG-1150, December 1990 (ML040140729)

5. U.S. Nuclear Regulatory Commission, NRC Order EA-12-049, "Issuance of Order to Modify Licenses with Regard to Requirements for Mitigation Strategies for Beyond-Design-Basis External Events," dated March 12, 2012 (ML12054A736)
6. U.S. Nuclear Regulatory Commission, NRC Order EA-12-051, "Issuance of Order to Modify Licenses with Regard to Reliable Spent Fuel Pool Instrumentation," dated March 12, 2012 (ML12054A682)
7. RES Memorandum, Subject: Project Plan for Spent Fuel Pool Scoping Study, July 26, 2011 (ML111570370)

**APPENDIX D: REGULATORY ANALYSIS AND BACKFITTING  
DISCUSSION TO DETERMINE THE SAFETY BENEFIT OF  
EXPEDITED TRANSFER OF SPENT FUEL AT A REFERENCE  
PLANT**

---

U.S. Nuclear Regulatory Commission  
Office of Nuclear Reactor Regulation

## ABBREVIATIONS AND ACRONYMS

ADAMS	Agencywide Documents Access and Management System
Bq	Becquerel
BLS	Bureau of Labor Statistics
BWR	boiling-water reactor
CDF	Core Damage Frequency
CFR	<i>Code of Federal Regulations</i>
CoC	certificate of compliance
Cs	cesium
DOE	U.S. Department of Energy
DSC	dry storage cask systems
EPA	U.S. Environmental Protection Agency
EPRI	Electric Power Research Institute
FR	<i>Federal Register</i>
FTE	Full-Time Equivalent
ISFSI	independent spent fuel storage installation
LCF	latent cancer fatality
LERF	Large Early Release Frequency
LNT	linear no-threshold
LOOP	loss of offsite power
MACCS2	MELCOR Accident Consequence Code System, Version 2
MELCOR	not an acronym
NPV	Net Present Value
NRC	Nuclear Regulatory Commission
NTTF	Near-Term Task Force
OCP	operating cycle phase
OMB	Office of Management and Budget
PAG	protective action guides
PGA	peak ground acceleration
PRM	petition for rulemaking
RA	Regulatory Analysis
SFP	spent fuel pool
SRM	Staff Requirements Memorandum
USGS	United States Geological Survey

## **D.1 INTRODUCTION**

This appendix, which is organized into five sections, presents the regulatory analysis and backfitting discussion to determine the safety benefit of expedited transfer of spent fuel at a reference plant:

- Section D.1 describes the nature of the problem and a clear statement of the objective of the proposed action.
- Section D.2 describes and clearly explains the alternative approaches considered.
- Section D.3 describes the attributes affected, the methodology used to evaluate benefits and costs, the analysis model, key data and assumptions, and results for the alternatives evaluated.
- Section D.4 presents the analytical results and findings including discussion of supplemental considerations, uncertainties in estimates, and results of sensitivity analyses on the overall costs and benefits.
- Section D.5 presents the preferred alternative and the basis for selection, discusses any decision criteria used, identifies and discusses the regulatory instrument to be used (as applicable), and explains the statutory basis for the action.

### **D.1.1 Statement of the Problem**

Various risk studies (most recently NUREG-1738, "Technical Study of Spent Fuel Pool Accident Risk at Decommissioning Nuclear Power Plants," February 2001) have shown that storage of spent fuel in a high-density configuration in spent fuel pools is safe and that the risk is appropriately low. These studies used simplified and sometimes bounding assumptions and models to characterize the likelihood and consequences of beyond-design-basis spent fuel pool accidents<sup>46</sup>. As part of NRC's post-9/11 security assessments, spent fuel pool modeling using detailed thermal-hydraulic and severe accident progression models integrated into the MELCOR code were developed and applied to assess the realistic heatup of spent fuel under various pool draining conditions. Moreover, in conjunction with these post-9/11 security assessments, NRC issued a new regulation in 2009, 10 CFR 50.54(hh)(2), that requires reactor licensees to develop and implement guidance and strategies intended, in part, to maintain or restore spent fuel pool cooling capabilities following certain beyond design basis events.

Recently, the agency has restated its views on the safety of spent fuel stored in high-density configurations in a response to Petition for Rulemaking (PRM)-51-10 and PRM-51-12 (73 FR 46204, August 8, 2008) as well as the revision to NUREG-1437 (the Generic Environmental Impact Statement for License Renewal, Draft Report for Comment). However, this position relies in part on the findings of the aforementioned security assessments, which are not publicly available. The events in Japan following the March 2011 earthquake has rekindled public and industry interest in understanding the consequences from postulated accidents associated with high-density spent fuel pool storage and the relative benefits of low-density spent fuel pool storage. This study provides an analysis of the health and safety benefits, if any,

---

<sup>46</sup> An overview of previous studies is provided in section 10.2 to the Spent Fuel Pool Study.

from moving from high-density to low-density spent fuel pool storage at the reference plant. This appendix assesses the costs and benefits of this activity, and then, for illustrative purposes, assesses whether the benefits are cost justified and substantial enough to justify a backfit to impose these requirements on the reference plant.

In response to these recent events, the staff has determined that it should confirm that high-density spent fuel pool configurations continue to provide adequate protection, and assess whether any safety benefits (or detriments) would occur from expedited transfer of spent fuel to dry cask storage at the reference plant.

The purpose of this regulatory analysis is to help ensure that:

- Appropriate alternatives to regulatory objectives are identified and analyzed.
- No clearly preferable alternative is available to this action.
- The costs of implementation are justified by its effect on overall protection of the public health and safety.

#### **D.1.2 Objective of Proposed Action**

Following the March 2011 accident at the Fukushima Daiichi nuclear power plant in Japan that resulted after the Tohoku Earthquake and subsequent tsunami, several stakeholders submitted comments to the Commission and staff requesting that regulatory action be taken to require the expedited transfer of spent fuel stored in spent fuel pools to dry cask storage. The rationale was that transferring the spent fuel to dry storage would lessen the potential consequences associated with a loss of spent fuel pool coolant inventory by decreasing the amount of spent fuel stored in these pools and thereby decreasing the heat generation rate and radionuclide source term associated with the spent fuel in pool storage.

As directed by the Commission in SRM-SECY-12-0025, dated March 9, 2012, the staff has undertaken regulatory actions that originated from the NTF recommendations to enhance reactor and spent fuel pool safety. On March 12, 2012, the staff issued Order EA-12-051, which requires that licensees install reliable means of remotely monitoring wide-range spent fuel pool levels to support effective prioritization of event mitigation and recovery actions in the event of a beyond-design-basis external event. In addition, the staff issued Order EA-12-049 which requires that licensees develop, implement, and maintain guidance and strategies to maintain or restore core cooling, containment, and spent fuel pool cooling capabilities following a beyond design basis external event. Upon full implementation of these Orders, spent fuel pool safety will be significantly increased.

While the staff has concluded, based on previous studies without these enhancements, that both spent fuel pools and dry casks provide adequate protection of public health and safety, the staff has determined that it should confirm that spent fuel pools continue to provide adequate protection.

This analysis uses information contained within the “Consequence Study of a Beyond-Design-Basis Earthquake Affecting the Spent Fuel Pool for a U.S. Mark I Boiling Water Reactor” (Spent Fuel Pool Study or main document), to evaluate whether there is a benefit at the reference plant in the study to change from high- to low-density storage configurations in the spent fuel pool.



This analysis calculates the potential benefit per reactor year resulting from expedited fuel transfer by comparing the safety of high-density fuel pool storage relative to low-density fuel pool storage. The comparison uses the initiating frequency and consequences from the Spent Fuel Pool Study as an indicator of any changes in the NRC's understanding of safe storage of spent fuel. The staff also used calculated results from previous spent fuel pool studies (i.e., NUREG-1353 and NUREG-1738) to extend the applicability of this evaluation to include other initiators, which could challenge spent fuel pool cooling or integrity.

## **D.2 IDENTIFICATION AND PRELIMINARY ANALYSIS OF ALTERNATIVE APPROACHES**

This section presents the analysis of the alternatives that the NRC considered to meet the regulatory goals identified in the previous section. The NRC considered the regulatory baseline and one alternative to change this baseline as discussed below.

### **D.2.1 Alternative 1 – Regulatory Baseline – Maintain the Existing Spent Fuel Storage Requirements**

This alternative reflects a Commission decision not to expedite the storage of spent fuel to dry cask storage, but to continue with NRC's existing licensing requirements for spent fuel storage. Under this alternative, spent fuel is moved into dry storage only as necessary to accommodate fuel assemblies being removed from the core during refueling operations. It also assumes that all applicable requirements and guidance to date have been implemented, but no implementation is assumed for related generic issues or other staff requirements or guidance that is unresolved or still under review.

The condition represented by this alternative is the storage of spent fuel in high-density racks<sup>47</sup> in the spent fuel pool, a relatively full spent fuel pool, compliance with all current regulatory requirements including those requirements associated with the following:

- 10 CFR 50.54(hh)(2) with respect to spent fuel configuration, and spent fuel pool preventive and mitigative capabilities,
- Order EA-12-051 that requires licensees to install reliable means of remotely monitoring wide-range spent fuel pool levels to support effective prioritization of event mitigation and recovery actions in the event of a beyond-design-basis external event, and
- Order EA-12-049 that requires licensees to develop, implement, and maintain guidance and strategies to maintain or restore core cooling, containment, and spent fuel pool cooling capabilities following a beyond design basis external event.

Furthermore, because spent fuel pools have a limited amount of available storage, even after licensees expanded their storage capacity using high-density storage racks, the current practice

---

<sup>47</sup> Most nuclear power plant spent fuel pools were originally designed for temporary storage of spent fuel. Starting in the 1980s, most pools were "re-racked" to utilize hardware that stores the assemblies in a more closely-spaced arrangement, thus allowing the storage of more assemblies in a high-density configuration.

of transferring spent fuel to dry storage in accordance with 10 CFR 72 is assumed to continue.<sup>48</sup> This alternative represents the baseline for estimating the incremental costs of alternative 2.

## **D.2.2 Alternative 2 – Low-density Spent Fuel Pool Storage**

Under this alternative, older spent fuel assemblies<sup>49</sup> are expeditiously moved from spent fuel pool storage to dry cask storage beginning in year 2014 to achieve and maintain a low-density loading of spent fuel in the existing high-density racks within five years. The situation where the spent fuel pool is re-racked to a low-density rack configuration was not evaluated because such a situation would be inefficient in terms of regulatory benefit given that much of the benefit could be achieved by storing less fuel in the existing high-density racks. Because of the low-density spent fuel pool loading, this alternative has less longer-lived radionuclide inventory in the spent fuel pool, a lower overall heat load in the pool, and a slight increase in the initial water inventory that displaces the removed spent fuel assemblies. In certain situations, this additional water could delay the clearing of the baseplate, which would temporarily inhibit natural air circulation cooling under and up through the racks should the spent fuel pool completely drain.

Due to the uncertainty associated with the schedule for the availability of a spent fuel repository, the reference plant has a plan to have sufficient on-site storage capacity (in-pool capacity and dry storage) to store all of the spent fuel discharged over the operating life of the plant until sufficient repository capacity becomes available. As a result, the analyzed incremental increase in costs results primarily from the increase in net present value cost for the early transfer of spent fuel into dry storage resulting from the earlier capital costs for new casks and for a dry storage facility.

The staff recognizes that there are cost and risk impacts associated with the transfer of spent fuel from the spent fuel pool to cask storage after five years of cooling and during long-term cask storage<sup>50</sup>. These cost and risk impacts, if included, would reduce the overall net benefit in relation to the regulatory baseline. These effects (e.g., the added risks of handling and moving casks) were conservatively ignored to calculate the potential benefit per reactor year by only comparing the safety of high-density fuel pool storage relative to low-density fuel pool storage and its implementation costs.

## **D.3 ESTIMATION AND EVALUATION OF VALUES AND IMPACTS**

---

<sup>48</sup> Maintenance of the existing spent fuel pool storage requirements would not limit the Commission's authority to add new requirements or update regulatory guidelines, as necessary. These actions and activities are a part of the regulatory baseline. However, these activities would be pursued as separate regulatory actions to resolve particular technical issues. Under this alternative, the NRC would take no action to require facilities to expedite the movement of spent fuel to achieve low-density loading in the spent fuel pool.

<sup>49</sup> Older spent fuel assemblies are those that have been placed in the spent fuel pool to cool for at least five years after discharge from the reactor core.

<sup>50</sup> EPRI report TR-1021049 assesses the cost and risk impacts (from a worker dose perspective) associated with transfer of spent nuclear fuel from spent fuel pools to dry storage after five years of cooling. The report concludes that expedited fuel movement would result in an increase cost to the U.S. nuclear industry of \$3.6 billion, with the increase primarily related to the additional capital costs for new casks and construction costs for the dry storage facilities.

This section discusses the benefits and costs of each action alternative relative to the baseline. Ideally, all costs and benefits are converted into monetary values. The total of benefits and costs are then algebraically summed to determine for which alternative the difference between the values and impacts was greatest. However, in some cases the assignment of monetary values to benefits is not provided because meaningful quantification is not possible.

### **D.3.1 Identification of Affected Attributes**

This section identifies the factors within the public and private sectors that the regulatory alternatives (discussed in section D.2) are expected to affect. These factors are classified as attributes using the list of potential attributes provided by the NRC in Chapter 5 of its Regulatory Analysis Technical Evaluation Handbook. The basis for selecting each attribute is presented below.

Affected attributes are the following:

- Public Health (Accident). This attribute measures expected changes in radiation exposure to the public due to changes in accident frequencies or accident consequences associated with the proposed action. The expected changes in radiation exposure are measured over a 50-mile radius from the plant site. The dose to the public is from reoccupation of the land and other activities following a severe accident. In addition, the dose to the public includes the occupational dose to workers for cleanup and decontamination of the contaminated land not onsite. The calculation for each alternative is made by subtracting the alternative from the regulatory baseline.
- Occupational Health (Accident). This attribute measures occupational health effects, for both immediate and long-term, associated with site workers because of changes in accident frequency or accident mitigation. Within the regulatory baseline, the short-term occupational exposure related to the accident occurs at the time of the accident and during the immediate management of the emergency and during decontamination and decommissioning of the onsite property. The radiological occupational exposure resulting from cleanup and refurbishment or decommissioning activities of the damaged facility to occupational workers are found within the long-term occupational exposure.
- Occupational Health (Routine). This attribute accounts for radiological exposures to workers during normal facility operations (i.e., non-accident situations). These occupational exposures occur during DSC loading and handling activities; ISFSI operations, maintenance, and surveillance activities; and preparing to ship the spent fuel offsite.

This attribute represents an estimate of health effects incurred during normal facility operations so accident probabilities are not relevant. As is true of other types of exposures, a net decrease in worker exposures is taken as positive; a net increase in worker exposures is taken as negative. This exposure is also subject to the dollar per person-rem conversion factor.

- Offsite Property. This attribute measures the expected total monetary effects on offsite property resulting from the proposed action. Changes to offsite property can take various forms, both direct, (e.g. land, food, and water) and indirect

(e.g. tourism). This attribute is typically the product of the change in accident frequency and the property consequences from the occurrence of an accident.

For the regulatory baseline, the offsite property costs are any property consequences resulting from any radiological release from the occurrence of an accident. Normal operational releases and those releases before severe accident are outside the scope of this regulatory analysis.

- Onsite Property. This attribute measures the expected monetary effects on onsite property, including replacement power costs, decontamination, and refurbishment costs, from the proposed action. There are two forms of onsite property costs that are evaluated. The first type is the cleanup and decontamination costs for the unit. The second type is the cost to replace the energy from the damaged or shutdown units.
- Industry Implementation. This attribute accounts for the projected net economic effect on the affected licensees to implement the mandated changes. Costs include procedural and administrative activities. Additional costs above the regulatory baseline are considered negative and cost savings are considered positive.
- Industry Operation. This attribute accounts for the projected net economic effect due to routine and recurring activities required by the proposed alternative on all affected licensees.
- NRC Implementation. This attribute accounts for the projected net economic effect on the NRC to place the proposed alternative into operation. NRC implementation costs and benefits incurred in addition to those expected under the regulatory baseline are included. Additional rulemaking, policy statements, new or expedited revision of guidance documents, and inspection procedures are examples of such costs.
- NRC Operation. This attribute accounts for the projected net economic effect on the NRC after the proposed action is implemented. Additional inspections, evaluations, or enforcement activities are examples of such costs.

Attributes that are not expected to be affected under any of the alternatives include the following: public health (routine), other government, general public, antitrust considerations, safeguards and security considerations, regulatory efficiency, improvements in knowledge, and environmental considerations.

### **D.3.2 Methodology Overview**

This section describes the process used to evaluate benefits and costs associated with the proposed regulatory framework alternatives. The benefits (values) include desirable changes in affected attributes (e.g., monetary savings and improved security and safety). The costs (impacts or burdens) include undesirable changes in affected attributes (e.g., increased monetary costs, and decreased security and safety).

The regulatory analysis methodology is specified by various guidance documents. The two documents that govern the NRC's voluntary regulatory analysis process are NUREG/BR-0058, Revision 4, "Regulatory Analysis (RA) Guidelines of the U.S. Nuclear Regulatory Commission,"

dated September 2004 (RA Guidelines), and NUREG/BR-0184, “Regulatory Analysis Technical Evaluation Handbook,” dated January 1997 (RA Handbook). The regulatory analysis identifies all attributes impacted by the proposed alternative and analyzes them either quantitatively or qualitatively as described in the previous section.

For the quantified regulatory analysis, the NRC staff develops expected values for each cost and benefit. The expected value is the product of the probability of the cost or benefit occurring and the consequences that would occur assuming the event actually happens. For each alternative, the staff first determines the probabilities and consequences for each cost and benefit, including the year the consequence is incurred. The NRC staff then discounts the consequences in future years to the current year of the regulatory action. Finally, the NRC staff sums the costs and the benefits for each alternative and compares them.

After performing a quantitative regulatory analysis, the NRC staff adds attributes that could only be qualified<sup>51</sup>. Based on the qualification of each attribute, uncertainties, sensitivities, and the quantified costs and benefits, the staff makes a recommendation for each alternative. If the benefits, both quantified and qualified, are greater than the quantified and qualified costs, then the staff recommends the alternative should be implemented. If the benefits, both quantified and qualified, are less than the quantified and qualified costs, then the staff recommends the alternative should not be implemented.<sup>52</sup>

### **D.3.2.1 Analysis Model**

This regulatory analysis measures the incremental impacts of the proposed regulatory framework alternative to the “continue with the existing regulatory framework” baseline, which reflects anticipated behavior in the event that the proposed alternatives are not adopted. Section D.4 presents the estimated incremental costs and savings of each alternative relative to continuing with NRC’s existing regulatory framework (alternative 1).

Key inputs into the analysis model are discussed in the following subsections.

#### **D.3.2.1.1 Baseline for the Analysis**

The regulatory baseline used in the analysis is to continue with NRC’s existing approach to spent fuel pool storage. This baseline assumes full compliance with existing NRC requirements, including current regulations and relevant orders. This is consistent with NUREG/BR-0058, “Regulatory Analysis Guidelines of the U.S. Nuclear Regulatory Commission,” Rev. 4, which states that, “in evaluating a new requirement..., the staff should assume that all existing NRC and Agreement State requirements have been implemented.”

---

<sup>51</sup> See NRC’s Regulatory Analysis Technical Evaluation Handbook, Section 4.3, “Estimation and Evaluation of Values and Impacts.”

<sup>52</sup> See NRC’s Regulatory Analysis Technical Evaluation Handbook, Section 4.5, “Decision Rationale.” Non-quantifiable attributes can only be factored into the decision in a judgmental way; the experience of the decisionmaker will strongly influence the weight that they are given. Qualitative attributes may be significant factors in regulatory decisions and should be considered, if appropriate.

### D.3.2.1.2 Discount Rates

In accordance with guidance from the Office of Management and Budget (OMB) and NUREG/BR-0058, Rev. 4, present-worth calculations are used to determine how much society would need to invest today to ensure that the designated dollar amount is available in a given year in the future. By using present-worth, costs and benefits, regardless of when averted in time, are valued equally. Based on OMB guidance Circular No. A-4, September 17, 2003, present-worth calculations are presented using both 3 percent and 7 percent real discount rates. The 3 percent rate approximates the real rate of return on long-term government debt, which serves as a proxy for the real rate of return on savings. This rate is appropriate when the primary effect of the regulation is on private consumption. Alternatively, the 7 percent rate approximates the marginal pretax real rate of return on an average investment in the private sector, and is the appropriate discount rate whenever the main effect of a regulation is to displace or alter the use of capital in the private sector.

Although the NRC is not bound to follow OMB guidance, the NRC has voluntarily complied with the present-worth calculations developed in OMB Circular No. A-4 and has stated so in the RA Guidelines and RA Handbook.

### D.3.2.2 Data

The data and assumptions used in analyzing the quantifiable impacts associated with the proposed alternative are discussed in this subsection. Information on attributes affected by the proposed regulatory framework alternatives were obtained from experienced NRC staff and other sources as referenced. The NRC staff considered the potential differences between the new requirements and the current requirements and has incorporated the proposed incremental changes into this regulatory analysis.

Available cost information is included in the backfitting analysis of the reference plant, which is provided for illustrative purposes. The NRC plans to use the insights from this analysis to inform a broader regulatory analysis to support decisionmakers in determining whether NRC's regulations should be changed to impose new generic requirements on all operating nuclear reactors.

#### D.3.2.2.1 Spent Fuel Pool Initiator Release Frequency

Section 1.5 of the Spent Fuel Pool Study provides an overview of contributors to spent fuel pool risk. The majority of spent fuel pool risk emanates from a loss of water from a sizeable leak in the spent fuel pool or a boil off in which operator action to inject water into the pool for an extended period is precluded. The release frequency from the spent fuel pool can then be characterized as the frequency of the initiator causing fuel uncovering multiplied by the probability of a release given fuel uncovering for the specific initiating event. The total release frequency is the sum of the frequency of releases from cask drops, seismic events, and other initiators. This value is given by:

$$F_{release} = \sum_i F_{initiator_i} \times P_{release_i}$$

Where  $F_{initiator}$  includes

- $F_{drop}$  = frequency of spent fuel uncovering from cask drops
- $F_{seismic-bin 3}$  = frequency of spent fuel uncovering from seismic bin 3 event

- $F_{\text{seismic-bin 4}}$  = frequency of spent fuel uncoverly from seismic bin 4 event
- $F_{\text{other}}$  = frequency of spent fuel uncoverly from sources other than cask drops and seismic
- $P_{\text{release}}$  = probability of release given spent fuel uncoverly for specific initiators

Source: Derived from Spent Fuel Pool Study, section B.4.

The Spent Fuel Pool Study provides a detailed analysis of the consequences, for a particular site and a calculation of  $F_{\text{seismic}}$  for seismic bin 3, a hazard exceedance frequency range provided in Table 4 of the Spent Fuel Pool Study and reproduced in Table 72.

**Table 72 Seismic Bins and Initiating Event Frequencies**

Bin No.	Bin Range (g)	Bin PGA (g)	Approximate Initiating Event Frequency (USGS 2008 model) (/yr)
1	0.05 - 0.3	0.12	$5.2 \times 10^{-4}$
2	0.3 - 0.5	0.4	$2.7 \times 10^{-5}$
3	0.5 - 1.0	0.7	$1.7 \times 10^{-5}$
4	> 1.0	1.2	$4.9 \times 10^{-6}$

The Spent Fuel Pool Study did not analyze initiators that contribute to spent fuel pool risk other than for seismic events defined by seismic bin no. 3. However past studies, such as NUREG-1353 and NUREG-1738, evaluated additional events that could contribute to risk and consequences from spent fuel pool fires. Table 74 summarizes these initiating-event-class fuel uncoverly frequencies. Uncoverly frequencies taken from past studies depend on the assumptions stated in those studies. Additionally, seismic bin no. 4 is included by extrapolating the results of this study. For seismic bin no. 3 and bin no. 4 events, the uncoverly frequency is the product of the initiating event frequency, ac power fragility, and the liner fragility.

The main report uses an ac power fragility value of 0.84 taken from NUREG-1150 as a surrogate for the conditional probability of normal spent fuel pool cooling and makeup not being available following a 0.7g earthquake. This simplifying assumption was made in light of the fact that the main report is not a probabilistic risk assessment (but rather a consequence analysis with probabilistic considerations) and that this value already approximates the upper bound value of 1.00. For the seismic bin no. 4 event, ac power fragility upper bound value of 1.00 was used in this regulatory analysis. In reality, the availability of normal spent fuel pool cooling and makeup would be a combination of the ac power fragility, the fragility of the actual equipment and its support equipment, and operator actions to recover spent fuel pool cooling capabilities using additional mitigation equipment and strategies implemented in response to Order EA-12-049, which were not considered in the main report. The modeling and consideration of these guidance and strategies to maintain or restore spent fuel pool cooling capabilities following a beyond design basis external event could result in a smaller value for spent fuel pool cooling and makeup failure conditional probability than the values used here and a resulting smaller initiating event fuel uncoverly frequency.

Section 4.1.5 of the main report describes the results from the nonlinear finite element analysis to estimate the likelihood of leakage from concrete cracking and related spent fuel pool liner failure for the 0.7g earthquake. Figure 27 shows that the maximum membrane effective strain is about 3.7 percent. Based on this calculated liner strain for the 0.7g earthquake, a structural analysis of the pool estimates that the spent fuel pool in this study has a 90% probability of surviving the 0.7g earthquake with no liner leakage (or conversely, a 10% probability of damaging the liner such that leakage will occur). As a result, a liner fragility value of 0.1 is used

for the seismic bin no. 3 initiating event. For the seismic bin no. 4 initiating event (i.e., 1.2g earthquake), a comparable structural analysis was not performed to determine the liner fragility value. As detailed in section 4.1.1 of the main report, the specific conditions for liner failure vary according to site conditions and spent fuel pool design. NUREG-1353 predicted the likelihood of liner failure from all potential earthquakes to be between about two and six times in a million years. NUREG-1738 predicted the likelihood of liner failure from all potential earthquakes to be between about two times in a million years and two times in 10 million years. Because a documented liner fragility value for a 1.2g earthquake for the reference plant is not readily available, a conservative bounding approach was used. A liner fragility value of 1.00 is used in this regulatory analysis for the best estimate, even though a realistic analysis may be able to justify a value a factor of 2 or more lower.

Past studies have reached generally similar conclusions about the relative contribution to risk from the seismic initiating events considered. Table 73 Frequency of Spent Fuel Pool Fuel Uncovery for Seismic Events summarizes the impact of the above modeling assumptions when comparing the seismic initiating event fuel uncovery frequencies from previous spent fuel pool accident regulatory analyses.

**Table 73 Frequency of Spent Fuel Pool Fuel Uncovery for Seismic Events**

Reference	Spent Fuel Pool Fuel Uncovery (per reactor-year)	Percent Increase in Fuel Uncovery Frequency Value
NUREG-1353 (1989) (BWR, best estimate) <sup>1</sup>	$7 \times 10^{-6}$	(10%)
NUREG-1738 <sup>2</sup>	$2 \times 10^{-6}$	315%
This regulatory analysis <sup>3</sup>	$6.3 \times 10^{-6}$	100%

1. This number was not multiplied by the stated conditional probability of having a zirconium fire of 0.25.
2. NUREG-1738 presented results for the two different seismic hazard models in wide use at the time (the Electric Power Research Institute and Lawrence Livermore National Labs models). The larger of the two values is listed above.
3. The initiating event frequency values are from Table 72. The likelihood of fuel uncovery is a product of initiating event frequency (e.g.,  $1.6 \times 10^{-5}$  for seismic bin no. 3), ac power fragility (0.84), and liner fragility (0.1). For seismic bin no. 4, the likelihood of fuel uncovery is a product of initiating event frequency ( $4.9 \times 10^{-6}$ ), ac power fragility of 1.0, and a liner fragility of 1.0 (i.e., 100-percent likelihood of ac power and pool liner failure).

As discussed in the SFPS report, the study was performed for a specific site and for a specific initiating event. Once fuel in the pool has become uncovered, it may still be coolable from natural circulation of air, depending on the amount of decay heat and the amount of cooling. In section 12.1 of the main report, the fuel is estimated to be air coolable for at least 72 hours for all but roughly 10 percent of the operating cycle. Factors affecting this value include the amount of fuel in the pool, its configuration, burnup, geometry of the fuel racks, etc. A partial draindown event with channeled fuel could impede airflow. In this case with no natural circulation of air through the racks, the cooling of the fuel by the spray flow would be the only effective cooling mechanism until the decay heat of the fuel is reduced.

For the seismic bin no. 4 event, the spent fuel is assumed to retain an air coolable geometry following this event that causes a moderate to large crack in the pool and results in full pool draindown. Information provided in NUREG/CR-5176 (Prassinis et al, 1989), which concludes that there is high confidence that spent fuel pool racks are sufficiently robust to remain generally intact with their fuel channels open supports this assumption. Furthermore, prior studies conclude that severe earthquakes are not expected to result in catastrophic failure of spent fuel



pool structural walls and floor or fuel racks. Section 4.2 of this study cites median fragility for the reactor building of about 1.6g. However, the main report did not perform a structural analysis to verify that the reference plant spent fuel and racks retain their structural integrity and air-coolable geometry following a 1.2g peak ground acceleration seismic event. Given the uncertainties involved, a bounding approach was used to evaluate the sensitivity of assuming the spent fuel is not air-coolable following a seismic bin no. 4 earthquake that causes a rapid draindown of the spent fuel pool. This was done by assuming a value of 1.0 for the high estimate of the conditional probability of release for the seismic bin no. 4 unsuccessful mitigation event.

For the cask drop event, spent fuel is assumed to retain an air coolable geometry because a postulated cask drop accident would most likely affect the fuel pool floor in the cask loading area. The overhead crane used to move the casks is designed to meet single failure proof criteria, and has interlocks and administrative controls that limit the motion of the crane over the spent fuel pool to the cask loading area, where no fuel is stored. Although improbable, crane failure is more likely to occur during hoisting operations when many components contribute to holding the cask than during translational motion when the hoist holding brakes are set. The hoisting activities occur over the cask loading area, and, in that location, the cask, if dropped, could have sufficient potential energy to damage the spent fuel pool floor. . However, the main report did not perform a structural analysis to verify that the reference plant spent fuel and racks retain their structural integrity and air-coolable geometry following a cask drop event. Given the uncertainties involved, a bounding approach was used to evaluate the sensitivity of assuming the spent fuel is not air-coolable following a cask drop accident. This was done by assuming a value of 1.0 for the high estimate of the conditional probability of release for the cask drop unsuccessful mitigation event.

To calculate the total release frequency, the uncover frequencies are multiplied by the conditional probability of release for each initiating event class. The conditional probability of release depends on the fraction of the operating cycle where the fuel is not air coolable. For the seismic bin no. 3 event analyzed in the SFPS, this was calculated to be the ratio of 60/730 days or 8.2% of the operating cycle. See Section 5.6.3 of the main document for further discussion. For the non-seismic and non-cask drop events taken from previous studies, the nature of the events may lead to a situation similar to a partial draindown where the rack baseplate is not cleared and airflow is impeded. For these events, the conditional release probability is assumed to be 100%.

When mitigation is credited, this study found that successful mitigation decreased the conditional probability by a factor of 19 for the seismic bin no. 3 event analyzed using mitigation measures required under 10 CFR 50.54 (hh)(2). The main report does not consider the post-Fukushima mitigation equipment and mitigation strategies for their use required under Order EA-12-049 and being implemented by the operating plants that are intended to increase the likelihood of restoring or maintaining power and mitigation capability during severe accidents. For the purposes of this regulatory analysis, it was assumed that successful mitigation decreased the conditional probability by a factor of 19 for all initiating events as determined in the main report. In reality, the effectiveness of post-Fukushima improvements to severe accident mitigation measures will depend on a variety of factors, which the SFPS did not consider, and which are expected to be more effective than what is assumed here. Although the likelihood of successful mitigation deployment is uncertain.

Table 74 summarizes the initiating event class fuel uncover frequencies, the conditional probability of release, and the total release frequency with and without mitigation.

**Table 74 Release Frequencies for Spent Fuel Pool Initiators**

Spent fuel loading configuration		1x4		1x4	
Initiating Event Class	Initiating Event Fuel Uncovery Frequency (per r-yr)	Conditional Probability of Release (Unsuccessful mitigation)	Release Frequency (Unsuccessful mitigation) (per r-yr)	Conditional Probability of Release (successful mitigation)	Release Frequency (successful mitigation) (per r-yr)
Seismic bin no. 3 event	$1.4 \times 10^{-6(3)}$	8.2%	$1.18 \times 10^{-7}$	0.43% <sup>(4)</sup>	$6.18 \times 10^{-9}$
Seismic bin no. 4 event	$4.9 \times 10^{-6(3)}$	8.2% – 100%	$4.03 \times 10^{-7} - 4.9 \times 10^{-6}$	0.43% <sup>(4)</sup>	$2.12 \times 10^{-8} - 2.58 \times 10^{-7}$
Cask / heavy load drop	$2 \times 10^{-7(2)}$	8.2% – 100%	$1.64 \times 10^{-8} - 2 \times 10^{-7}$	0.43% <sup>(4)</sup>	$8.65 \times 10^{-10} - 1.05 \times 10^{-8}$
LOOP – severe weather	$1 \times 10^{-7(2)}$	100%	$1.00 \times 10^{-7}$	0.43% <sup>(4)</sup>	$5.26 \times 10^{-9}$
LOOP – other	$3 \times 10^{-8(2)}$	100%	$3.00 \times 10^{-8}$	0.43% <sup>(4)</sup>	$1.58 \times 10^{-9}$
Internal fire	$2 \times 10^{-8(2)}$	100%	$2.00 \times 10^{-8}$	0.43% <sup>(4)</sup>	$1.05 \times 10^{-9}$
Loss of pool cooling	$1.5 \times 10^{-8(1)}$	100%	$1.50 \times 10^{-8}$	0.43% <sup>(4)</sup>	$7.89 \times 10^{-10}$
Loss of coolant inventory	$3 \times 10^{-9(2)}$	100%	$3.00 \times 10^{-9}$	0.43% <sup>(4)</sup>	$1.58 \times 10^{-10}$
Inadvertent aircraft	$3 \times 10^{-9(2)}$	100%	$3.00 \times 10^{-9}$	0.43% <sup>(4)</sup>	$1.58 \times 10^{-10}$
Missiles – general	$2.5 \times 10^{-9(1)}$	100%	$2.50 \times 10^{-9}$	0.43% <sup>(4)</sup>	$1.32 \times 10^{-10}$
Missiles - tornado	$1 \times 10^{-9(2)}$	100%	$1.00 \times 10^{-9}$	0.43% <sup>(4)</sup>	$5.26 \times 10^{-11}$
Pneumatic seal failures	n/a <sup>(5)</sup>				
Total			$7.11 \times 10^{-7} - 5.39 \times 10^{-6}$		$3.74 \times 10^{-8} - 2.84 \times 10^{-7}$

1. Values from NUREG-1353. These numbers were multiplied by the stated conditional probability of having a zirconium fire of 0.25.
2. Values from NUREG-1738
3. Initiating event frequency values from Spent Fuel Pool Study, Table 4. The likelihood of fuel uncovery is a product of initiating event frequency (e.g.,  $1.6 \times 10^{-5}$  for seismic bin no. 3), ac power fragility (0.84), and liner fragility (0.1). For seismic bin no. 4, the likelihood of fuel uncovery is a product of initiating event frequency ( $4.9 \times 10^{-6}$ ), ac power fragility of 1.0, and a liner fragility of 1.0 (e.g., 100-percent likelihood of ac power and pool liner failure).
4. The conditional probability of release with successful mitigation with deployed 50.54(hh)(2) equipment is the quotient of OCP probability (60/730 or 8.2%) divided by the mitigation benefit in reducing the release likelihood (factor of 19). See Section 5.6.3 of the main document for further discussion. Additional mitigation equipment and mitigation strategies under Order EA-12-049 would further enhance the likelihood of successful mitigation, thereby further reducing the value for the conditional probability of release with successful mitigation.
5. As discussed in Table 3 of the main report, the reference plant has gates with mechanical seals to prevent leakage. These seals are kept under pressure by passive mechanical means (i.e., do not depend on air pressure, ac power, or dc power). Therefore, pneumatic seal failures are not applicable for the reference plant.

Based on this information, the values used in this regulatory analysis for  $F_{\text{release}}$  is are summarized in Table 75.

**Table 75 Spent Fuel Pool Release Frequency Estimates**

Parameter	Unsuccessful mitigation			Successful mitigation				
	Low	Best	High	Low	Best	High		
$F_{\text{release}}$	$7.11 \times 10^{-7}$			$5.39 \times 10^{-6}$			$3.74 \times 10^{-8}$	$2.84 \times 10^{-7}$

These release frequency values are subject to the assumption of unsuccessful deployment of mitigation and the other assumptions contained in this analysis and those stated in Table 3 of the main report. A comparison of the release frequencies (total and delta) used in this regulatory analysis to the release frequencies used for only seismic bin no. 3 in the Spent Fuel Pool Study is provided in Table 76.

**Table 76 Release Frequency Comparison Between Inclusion of All Initiator Event Classes to the Seismic Bin No. 3 Event**

Mitigation Case	Release Frequency for All Initiator Events Classes (per r-yr)	Release Frequency for the Seismic Bin No. 3 Event (per r-yr)	Net Percent Increase in Release Frequency
Unsuccessful Mitigation	$7.11 \times 10^{-7} - 5.39 \times 10^{-6}$	$1.18 \times 10^{-7}$	505% – 4489%
Successful Mitigation	$3.74 \times 10^{-8} - 2.84 \times 10^{-7}$	$6.18 \times 10^{-9}$	505% – 4489%
Delta change	$6.74 \times 10^{-7} - 5.11 \times 10^{-6}$	$1.11 \times 10^{-7}$	505% – 4489%

#### D.3.2.2.2 Duration of On-site Spent Fuel Storage Risk

The reference plant operating license expires in 2034. For this analysis, it is assumed that the plant operates through the term of its operating license and that the licensee continues to store spent fuel in the pool following commercial operation<sup>53</sup> to allow the spent fuel to cool sufficiently before placing into dry storage. For all cases analyzed, it was assumed that spent fuel stored in the spent fuel pool is susceptible to the risk of spent fuel fires for up to one year after permanent cessation of operations.

#### D.3.2.2.3 Cost/Benefit Inflaters

The consequences for some attributes are estimated based on the values published in the NRC Regulatory Analysis Handbook. Within the NRC Regulatory Analysis Handbook, the information in relation to severe reactor accident consequences is provided in previous year dollars. To evaluate the costs and benefits consistently, the consequences are inflated. The most common inflator is the Consumer-Price Index for all urban consumers (CPI-U), developed by the U.S. Department of Labor, Bureau of Labor Statistics. Using the CPI-U, the previous year dollars were converted to the year 2012. The formula to determine the amount in 2012 dollars is

$$\frac{\text{CPIU}_{2012}}{\text{CPIU}_{\text{Base Year}}} * \text{Consequence}_{\text{Base Year}} = \text{Consequence}_{2012}$$

Values of CPI-U used in this regulatory analysis are summarized in Table 77.

**Table 77 Consumer Price Index – All Urban Consumers Inflator**

Base Year	CPI-U Inflator for Year 2012
2005	1.1756
2006	1.1389

<sup>53</sup> Decommissioning of the unit must be completed within 60 years of permanent cessation of operations under 10 CFR 50.82, "Termination of License." Completion of decommissioning beyond 60 years will be approved by the Commission only when necessary to protect public health and safety.

Base Year	CPI-U Inflator for Year 2012
2007	1.1073
2008	1.0664
2009	1.0702
2010	1.0529
2011	1.0207

Source: [www.bis.gov/data/inflation\\_calculator.htm](http://www.bis.gov/data/inflation_calculator.htm)

#### D.3.2.2.4 Dollar per Person-Rem Conversion Factor

Using the dollar value of the health detriment and a risk factor that establishes the nominal probability for stochastic health effects attributable to radiological exposure (fatal and non-fatal cancers and hereditary effects) provides a dollar per person-rem of \$2,000, rounded to the nearest thousand, according to NUREG-1530, "Reassessment of NRC's Dollar per Person-Rem Conversion Factor Policy," dated December 1995.

The NRC currently use a value of statistical life (VSL)<sup>54</sup> of \$3 million based on NUREG-1530, and a cancer risk factor of  $7.0 \times 10^{-4}$ , which is a reduction to the closest significant digit of a recommendation by the International Commission on Radiation Protection (ICRP) in Publication No. 60. Therefore, the dollar per person-rem is equal to \$3 million times  $7.0 \times 10^{-4}$  rounded to the nearest thousand (due to uncertainties) or \$2,000.

#### D.3.2.2.5 Onsite Property Decontamination, Repair, and Refurbishment Costs

Spent fuel pool accident risks have significant contributions from onsite property monetary losses (e.g., repair and refurbishment) and plant decontamination. The risk dominant accident sequences involve the failure of the pool due to seismic or load drop events resulting in the loss of pool integrity. This scenario results in loss of spent fuel pool water inventory, zircaloy cladding fire initiation with propagation through the spent fuel assemblies stored in the pool, and an uncontrolled radiological release from the reactor building. The NRC assumes that, based on the current regulatory framework, with insights from the Fukushima Dai-ichi accident, that onsite property would be radiologically affected in the following way. The consequences of a spent fuel fire are expected to be similar to the Category II accident as defined in NUREG/CR-5281, section 3.2.4. Based on this reference, the cleanup and decontamination costs are estimated to be approximately \$165 million (1983 dollars) and the cost for permanent disposal of the damaged fuel is \$26 million (1983 dollars). Using Table C.95 from the RA Handbook, the pool repair to is expected to cost \$72 million (1983 dollars). Adjusting these estimated costs using the CPI-U inflator formula and using a multiplier of three to model the high estimate and a divider of two to model the low estimate results in the values provided in Table 78.

<sup>54</sup> The value of a statistical life (VSL) is the monetary value of a mortality risk reduction that would prevent one statistical (as opposed to an identified) death (Jones-Lee, 2004). The VSL is a key component in the calculation of the dollar per person-rem value, which is the product of the VSL multiplied by a risk coefficient.

**Table 78 Onsite Property Decontamination, Repair, and Refurbishment Costs**

Onsite Property Cost Element	1983 dollars			2013 dollars		
	Best Estimate	High Estimate	Low Estimate	Best Estimate	High Estimate	Low Estimate
Cleanup and decontamination	\$165,000,000	\$495,000,000	\$82,500,000	\$371,250,000	\$1,113,750,000	\$185,625,000
Repair Pool	\$72,000,000	\$216,000,000	\$36,000,000	\$162,000,000	\$486,000,000	\$81,000,000
Disposal of damaged fuel	\$26,000,000	\$78,000,000	\$13,000,000	\$58,500,000	\$175,500,000	\$29,250,000
Total	\$263,000,000	\$789,000,000	\$131,500,000	\$591,750,000	\$1,775,250,000	\$295,875,000

### D.3.2.2.6 Replacement Energy Costs

Replacement energy costs are the costs for replacing the energy from the nuclear power plant due to a plant shutdown to install required equipment or due to an accident.<sup>55</sup> The NRC assumes that replacement energy costs would be required until onsite decontamination and repair efforts are completed or the unit is retired.

The NRC assumes that licensees engage in power purchase agreements (PPA)<sup>56</sup> to economically purchase replacement power. A PPA is a legal contract between an electricity generator (licensee) and a power purchaser. The NRC assumes that a licensee will not be able to replace the power through other generation for seven years and would have to buy power from the market. Although not all licensees may have PPAs, the licensee will still replace the lost energy any time that the nuclear power plant is not operating to meet its electrical power supply obligations. The NRC assumes that after 7 years, the onsite decontamination and repair efforts are completed or the unit is retired and other power sources will be developed to replace the unit's lost electrical generation capability.

For the replacement energy cost calculation in this regulatory analysis, the NRC assumes that the reference plant is located on a multi-unit site. For the high estimate case, the NRC assumes that replacement energy is purchased for both the accident unit and the co-located unit at the site.

### D.3.2.2.7 Occupational Worker Exposure (Accident)

There are two types of occupational exposure related to accidents: short-term and long-term. The first occurs at the time of the accident and during the immediate management of the emergency. The second is a long-term exposure, presumably at significantly lower individual rates, associated with the cleanup and refurbishment or decommissioning of the damaged facility. The value gained in the avoidance of both types of exposure is conditioned on the change in frequency of the accident's occurrence.

<sup>55</sup> The replacement energy cost is only the cost to buy the energy for production on the market. Therefore, the cost would be the cost of buying the cheapest energy. These estimates do not include transmission or distribution costs.

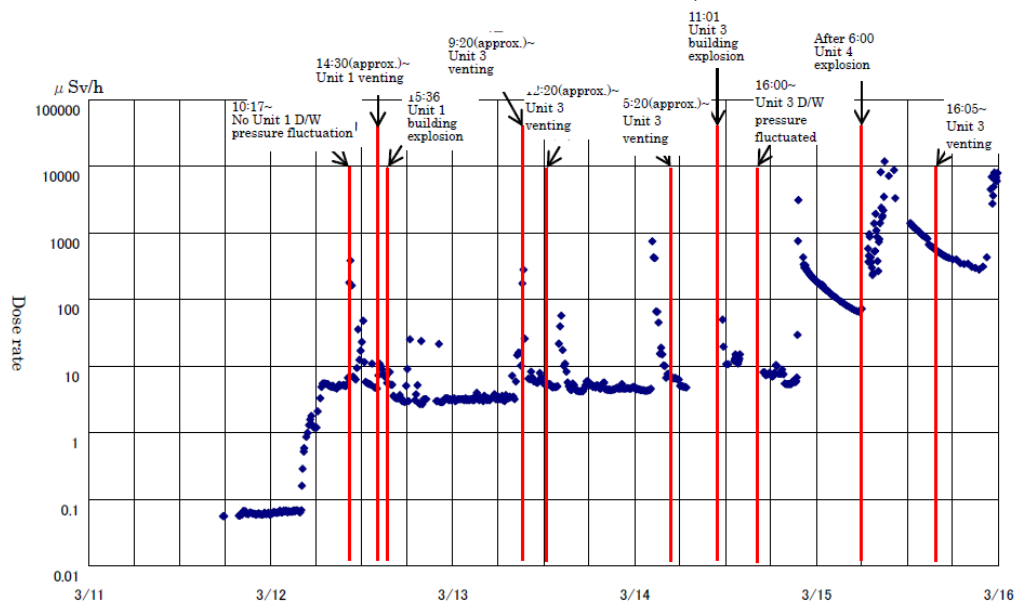
<sup>56</sup> A power purchase agreement is a contract between two parties, one who generates electricity for the purpose of sale (the seller) and one who is looking to purchase electricity (the buyer). The PPA defines all of the commercial terms for the sale of electricity between the two parties, including when the project will begin commercial operation, schedule for delivery of electricity, penalties for under delivery, payment terms, and termination.

The experiences at the Three Mile Island Unit 2 (TMI-2), the Chernobyl, and the Fukushima nuclear power plants illustrated that significant occupational exposures could result from performing activities outside the control room during a power reactor accident. At TMI-2, the average occupational exposure related to the incident was approximately 1.0 rem, with a collective dose of 1,000 person-rem occurring over a 4-month span, after which time occupational exposure approached pre-accident levels. For Chernobyl, the average dose for persons closest to the plant was 3.3 person-rem (RA Handbook p. 5.30), yielding an average value of 3,300 person-rem.

After the Fukushima unit 1 building explosion on March 12, 2011, the unit 3 building explosion on March 14, and the unit 4 building explosion and the exposure of the unit 2 reactor fuel rods on March 15, radioactive materials were release into the environment and surrounding areas of the Fukushima Dai-ichi nuclear power plant. Measurement and evaluation of radiation exposure levels for workers engaged in emergency work at the Fukushima Daiichi NPS have been implemented continuously since the Tohoku Earthquake.

As shown in Figure 142, the dose rate in the vicinity of the main gate at the Fukushima Dai-ichi site near the time of the Unit 4 explosion varied between 20 mrem and 1.0 rem per hour (between 200 and 10,000  $\mu\text{Sv}$  per hour).

**Figure 142: Dose Rate in Vicinity of Fukushima Daiichi Nuclear Plant Site Main Gate between March 11 and March 16, 2011**



Source: Fukushima Nuclear Accident Analysis Report p. 371.

On March 22 and 23, surveys of the airborne radioactivity and dose rates around the Fukushima Daiichi site were collected and documented. The dose rates are shown on Figure 143.

**Figure 143: Fukushima Daiichi Site Dose Rates between March 22 and March 23, 2011**



Source: INPO 11-005, p 41

The distribution of total monthly exposure for workers engaged in radiation work at the Fukushima Daiichi NPS for the first three months following the March 2011 accident is provided in Table 79.

**Table 79 Average Accident Occupational Exposure at Fukushima Dai-ichi Nuclear Power Plant from March to May 2011**

Total Radiation Exposure (mSv)	Number of Plant Workers Exposed		
	March 2011 <sup>1</sup>	April 2011 <sup>2</sup>	May 2011 <sup>3</sup>
≥ 250	6	0	0
200 - 249	2	0	0
150 - 199	14	0	0
100 - 149	77	0	0
50 - 99	309	3	0
20 - 49	859	81	19
10 - 19	1041	310	144
< 10	1434	3214	2854
Total number of workers	3742	3608	3017

1. Maximum March 2011 occupational exposure was 670.4 mSv.

2. Maximum April 2011 occupational exposure was 69.3 mSv.

3. Maximum May 2011 occupational exposure was 41.6 mSv.

4. One mSv is equal to 0.1 rem.

Source: Wada et al, Occupational and Environmental Medicine, 2012 August; 69(8): p. 600.

To estimate the monthly total occupational radiation exposure received by all workers, a high estimate, best estimate, and low estimate were calculated based on the maximum category value, the midpoint category value, and the first quartile category value. The results are tabulated in Table 80.



**Table 80 Estimated Immediate Accident Occupational Monthly Exposure at Fukushima**

Radiation Exposure (mSv)	Best Estimate			High Estimate			Low Estimate		
	Category	Radiation Exposure (mSv)		Category	Radiation Exposure (mSv)		Category	Radiation Exposure (mSv)	
	March 2011	April 2011	May 2011	March 2011	April 2011	May 2011	March 2011	April 2011	May 2011
≥ 250	460.2			670.4			355.1		
200 - 249	224.5			249			212.25		
150 - 199	174.5			199			162.25		
100 - 149	124.5			149			112.25		
50 - 99	74.5	69.3		99	69.3		62.25	62.25	
20 - 49	34.5	34.5	34.5	49	49	41.6	27.25	27.25	27.25
10 - 19	14.5	14.5	14.5	19	19	19	12.25	12.25	12.25
< 10	5	5	5	10	10	10	2.5	2.5	2.5
Total Monthly Dose	90,200	23,600	17,000	125,600	42,200	32,100	72,500	14,200	9,400
Avg Worker Dose	24.1	6.5	5.6	33.6	11.7	10.6	19.4	3.9	3.1

The immediate accident occupational exposure for a spent fuel pool accident shown in Table 81 is estimated based on the Fukushima data and the following assumptions:

- The immediate accident period lasts for one year,
- The workforce during the immediate accident period is 3,700 workers, and
- The average worker radiation exposure remains constant at the May 2011 value from May 2011 through February 2012.

**Table 81 Immediate Accident Occupational Exposure for a Spent Fuel Pool Fire**

Case	Immediate Accident Occupational Exposure (averted person-rem)
Low Estimate	18,070
Best Estimate	28,380
High Estimate	48,880

After the immediate response to a spent fuel pool fire, a long process of cleanup and refurbishment or decommissioning will follow. The Fukushima Nuclear Accident Analysis Report states, "The average value for 5,128 people in April of 2012 was 1.07 mSv per worker due to decreasing trends in environment dose rates (p 415). The NRC assumes that the process of cleanup and refurbishment or decommissioning will begin one year after the accident and will take seven years to complete. During those seven years, the NRC assumes that each occupational worker at the damaged reactor site will be exposed to 1.07 mSv per month (0.107 rem per month) for the duration of the cleanup and refurbishment or decommissioning. Assuming the average value for 5,128 workers would remain for the duration yields a cumulative long-term occupational dose of 46,000 person-rem.

In NUREG/CR-5281, Jo et al. (1989) conducted what essentially amounted to a regulatory analysis of a non-reactor nuclear fuel cycle facility using the 1983 Handbook (Heaberlin et al. 1983) as guidance. The accidental occupational exposure was assumed to be similar to that from TMI-2, which is 4,580 person-rem.

As described in the RA Handbook (p 5.30), the DOE (1987) summarized results on the collective dose received by the populace surrounding the Chernobyl accident. Average dose equivalents of 3.3 rem per person, 45 rem per person, and 5.3 rem per person were estimated for residents within 3 km, between 3 km and 15 km, and between 15 km and 30 km of Chernobyl, respectively (Mubayi et al. 1995, p. A-5). Assuming 1,000 workers and a 4.2 multiplier, an estimate radiation exposure of 14,000 person-rem results.



Site worker exposures following a spent fuel pool accident could be greater than that of a reactor core melt accident. This is because a spent fuel pool stores significantly more fuel assemblies than a reactor core. Additionally, radionuclides released during a spent fuel pool accident have longer half-lives (e.g., Cesium-137) than those that would be released during a reactor accident. Given the uncertainties in existing data and variability in severe accident parameters and worker response, Table 82 provides the long-term occupational dose used in this regulatory analysis to analyze spent fuel pool fires.

**Table 82 Long-Term Accident Occupational Exposure for a Spent Fuel Pool Fire**

Case	Immediate Accident Occupational Exposure (averted person-rem)
Low Estimate	4,580
Best Estimate	14,000
High Estimate	46,000

#### **D.3.2.2.8 Long-Term Habitability Criteria**

The long-term phase is the period following the seven-day emergency phase and is modeled for 50 years to calculate consequences from exposure of the average person. Radiation exposure during this phase is mainly from external radiation from trace contaminants that remain after the land is decontaminated, or in lightly contaminated areas where no decontamination was required. Internal radiation exposures may also occur during this period, including inhalation of resuspended radionuclides and ingestion of food and water with trace contaminants. Depending on the relevant protective action guides (PAGs) and the level of radiation, food, and water below a certain limit could be considered adequately safe for ingestion, and lightly contaminated areas could be considered habitable.

A long-term cleanup policy for recovery after a severe nuclear power plant accident does not currently exist. The actual decisions regarding how land would be recovered and populations relocated after an accident would be made by a number of local, state, and federal jurisdictions and would most likely be based on a long-term cleanup strategy, which is currently being developed by the NRC, EPA, and other Federal agencies. Furthermore, a cleanup standard may not have an explicit dose level for cleanup. Instead, the cleanup strategy may give local jurisdictions the ability to develop localized cleanup goals after an accident, to allow for a number of factors that include sociopolitical, technical, and economic considerations.

Site-specific values are used to determine long-term habitability. For habitability, most states adhere to EPA intermediate phase protective action guides that allow a dose of 2 rem in the first year and 500 mrem each year thereafter. This habitability criterion was used in previous spent fuel pool studies, which used 4 rem in 5 years to represent these PAG levels (e.g., 2 rem in year one, followed by 0.5 rem each successive year). However, consistent with the location of the reference plant, the Spent Fuel Pool Study analysis utilizes the State of Pennsylvania habitability criterion of 500 mrem beginning in the first year (and each following year). The use of this long-term habitability criterion reduces the predicted long-term population doses and

health effects and increases the costs associated with interdiction, decontamination, and condemnation.<sup>57</sup>

Given the uncertainties in which long-term habitability criterion would be used, Table 83 provides the long-term phase habitability criterion used in this analysis to analyze the consequences of spent fuel pool fires on public health (accident).

**Table 83 Long-Term Habitability Criterion**

Case	Long-Term Habitability Criterion	Protective Action Basis
Low Estimate	500 mrem annually	Pennsylvania dose limit to the public
Best Estimate	2 rem in the first year and 500 mrem each year thereafter	EPA intermediate phase PAGs
High Estimate	2 rem annually	EPA intermediate phase PAG: first year

Based on the average population dose for a release estimated using a sensitivity analysis, the public dose for the two EPA protective action bases was estimated by scaling population dose calculated using the Pennsylvania dose limit. The habitability criterion scaling factors used are provided in Table 84.

**Table 84 Habitability Criterion Scaling Factors**

	500 mrem	2 rem in the first year and 500 mrem each year thereafter	2 rem
Population Dose within 50 miles	100%	207%	278%
Total Population Dose	100%	165%	192%

The use of these habitability criteria also affects the values of offsite property damage used in this analysis. Certain metrics such as offsite property damage, the number of displaced individuals (either temporarily or permanently) and the extent to which such actions may be needed are inversely proportional to changes in collective dose resulting from changes in habitability criteria.

The impacts for alternate protective action levels were produced by examining the sensitivity analyses used to evaluate the effect of alternate protective action levels on land contamination, which were based on the results for a release from a high-density loading without credit for mitigation during OCP3. Scaling factors for different protective action levels were derived from this case. For a very large release that led to economic impacts beyond 50 miles, the sensitivity of the results within 50 miles to different protective action levels is less than the sensitivity of results beyond 50 miles. For significantly lower release magnitudes associated with the low density and successful mitigation cases, the scaling approach used can predict higher economic consequences within 50 miles than for the total. This implies that the economic impacts beyond 50 miles would be small relative to the economic impacts within 50 miles, and the total scaled

<sup>57</sup> Interdiction and condemnation refer to the relocation of people from contaminated areas according to the habitability criterion. Interdiction is the temporary relocation of the affected population while decontamination, natural weathering, and radioactive decay reduce the contamination levels. Condemnation is the permanent relocation of the affected population if decontamination, natural weathering, and radioactive decay cannot adequately reduce contamination levels to habitability limits within 30 years.

economic impact is therefore set equal to the scaled economic impact within 50 miles. The economic consequences scaling factors used are provided in Table 85.

**Table 85 Economic Consequences Scaling Factors as a Function of Habitability Criteria**

	500 mrem	2 rem in the first year and 500 mrem each year thereafter	2 rem
Economic Consequences within 50 miles	100%	67%	56%
Total Economic Consequences	100%	43%	31%

These criteria provide a benchmark for understanding the nature and the extent of the relationship between collective dose, economic consequences, and habitability criteria following a severe spent fuel pool accident. These measures are subject to large uncertainties, as it is difficult to model the impact of disruptions to many different aspects of local economies, the loss of infrastructure on the general U.S. economy, or the details of how long-term protective actions would be performed.

#### **D.3.2.2.9 Other Key Data**

All monetized costs are expressed in 2012 dollars. Ongoing costs of operation related to the alternatives are assumed to begin in 2014 unless otherwise stated, and are modeled on an annual cost basis.

Estimates were made for one-time implementation costs. The staff assumes that these costs will be incurred in the first year of the analysis unless otherwise noted.

Estimates were made for recurring annual operating expenses. The values for annual operating expenses are modeled as a constant expense for each year of the analysis horizon. An annuity calculation was performed to discount these annual expenses to 2012 dollar values.

Reference plant site population data was projected to year 2011 using the latest version of the computer code SECPOP2000. SECPOP2000 uses 2000 census data and applies a multiplier value of 1.1051 from the U.S. Census Bureau to account for the average population growth in the United States from 2000 to 2011 as discussed in section 7.1.3 of the main report. No further population growth was evaluated in this appendix.

#### **D.3.2.3 Assumptions**

The Spent Fuel Pool Study is used to inform this analysis is a consequence study based on the occurrence of a postulated beyond-design-basis earthquake (with an estimated frequency of occurrence of one event in 60,000 years) to a selected U.S. Mark I BWR spent fuel pool with a unit-specific spent fuel pool. The Spent Fuel Pool Study major assumptions are listed in section 2 of the main document. Additional assumptions used for this analysis are discussed below. The costs presented in this analysis are based on estimates by the authors or cited documents. It should be noted that this is a generic cost estimate and should be used accordingly. Site-specific features may result in higher or lower costs than those estimated.

##### **D.3.2.3.1 Projected Number of Outages and Spent Fuel Assemblies**

The reference plant is on a 24-month refueling cycle and is estimated to require eleven refueling outages between 2012 and the end of its operating license in 2034. It is assumed that

284 assemblies are offloaded to the spent fuel pool during each outage based on information in section 5.1 of the main document. The full core of 764 assemblies is offloaded to the spent fuel pool upon operating license expiration.

The analysis for the reference plant is based on a high-density spent fuel pool inventory of 3,055 assemblies in a high-density 1x4 loading configuration, a number based on the pool capacity of 3,819 assemblies, reduced by 764 assemblies to accommodate a full core offload capability using the existing high-density racking. In a low density 1x4 with empties configuration, the spent fuel pool stores 852 assemblies. The number of spent fuel assemblies required up to operating license expiration is calculated based on the existing high-density spent fuel pool inventory, the number added from refueling outages, and the full reactor core inventory and is provided in Table 86.

**Table 86 Number of Spent Fuel Assemblies Remaining through Operating License Expiration**

Category	Inventory	Number	No. of spent fuel assemblies
Current spent fuel pool inventory	3,055	1	3,055
refueling	284	11	3,124
reactor core	764	1	764
Total			6,943

#### D.3.2.3.2 Dry Storage Capacity

Three companies supply most of the dry storage technologies to U.S. commercial nuclear power plants. These companies are Holtec International, Inc. (Holtec), NAC International, Inc. (NAC), and Transnuclear, Inc. (Transnuclear). The dry storage cask systems<sup>58</sup> (DSCs) for all three companies are certified by the NRC for storage of high burnup spent fuel (i.e., burnups greater than 45 GWd/MTU), using both regional and uniform loading of spent fuel in the packages. A summary of a representative sampling of dry storage canisters commercially available to the reference plant for BWR fuel storage is provided in Table 87.

**Table 87 Representative Sampling of Commercially Available BWR Spent Fuel Dry Storage Technology**

Vendor Package	Fuel Type	Canister Type	Capacity (Assemblies)	Maximum Decay Heat Per Package <sup>1</sup> (kW)
Holtec HI-STORM	BWR	MPC-68	68	34
Holtec HI-STORM FW	BWR	MPC-89	89	46.36
NAC MAGNASTOR	BWR	87B	87	33
Transnuclear NUHOMS	BWR	61BTH	61	31.2
Transnuclear TN-68	BWR	Bolted	68	30

The maximum decay heat per assembly for uniform loading is estimated by dividing the package decay heat by the number of assemblies. The maximum decay heat per assembly under regional loading schemes will generally be higher than the maximum decay heat per assembly assuming uniform loading for a smaller number of assemblies. Cask certificates of compliance provide the specific maximum assembly decay heat limits for each storage location in the basket.

Source: EPRI TR-1025206, p. 2-11.

<sup>58</sup> The term dry storage cask system (DSC) includes dual-purpose canister based systems, dual-purpose casks, and storage-only dry storage casks and canister systems.

### D.3.2.3.3 Fuel Assembly Decay Heat as a Function of Burnup and Cooling Time

As fuel assembly burnups increase, the decay heat of the fuel assembly (watts per assembly) increases. Decay heat also can vary significantly with initial enrichment and assembly irradiation parameters. Spent fuel burnups have gradually increased since the 1990s with average BWR burnups about 43 GWd/MTU and range between 40 and 50 GWd/MTU. Spent fuel assembly average decay heat for a 40 GWd/MTU BWR assembly that has cooled for five years is approximately 360 watts/assembly. The average decay heat for a 50 GWd/MTU assembly that has cooled for five years is approximately 520 watts per assembly (EPRI TR-1021049, p. 2-3, Regulatory Guide 3.54). The average BWR spent fuel assembly that has cooled for five years is approximately 410 watts/assembly.

**Table 88 Canister Storage Capacity Based on Heat Rate Limitations**

Vendor Package	Capacity (Assemblies)	Maximum Decay Heat Per Package <sup>1</sup> (kW)	Max. Capacity based on decay heat		
			410w per assembly	520w per assembly	% Additional Canisters
Holtec HI-STORM	68	34	68.00	65.38	4.0%
Holtec HI-STORM FW	89	46.36	89.00	89.00	0.0%
NAC MAGNASTOR	87	33	80.49	63.46	37.1%
Transnuclear NUHOMS	61	31.2	61.00	60.00	1.7%
Transnuclear TN-68	68	30	68.00	57.69	17.9%

Based on the average BWR spent fuel assembly that emits 410 watts after it has cooled for five years, Table 88 shows that all of the dry storage canisters can be filled to capacity with the exception of the NAC MAGNASTOR, without exceeding the maximum decay heat per package rating, subject to restrictions on loading pattern. For 50 GWd/MTU assemblies that emit 520 watts after they have cooled for five years, fewer assemblies can be stored in a cask to ensure that it does not exceed the maximum decay heat rating. The number of additional dry storage casks required depends on the vendor package selected and range between no additional canisters to almost 40% additional canisters. Additional DSCs, which are required because of high heat load, are estimated in this appendix. For this regulatory analysis, the Transnuclear TN-68 dry casks are evaluated because the reference plant's ISFSI for dry cask storage utilizes the TN-68 cask design as discussed in section 1.3 of the main document. The currently approved minimum cooling time for fuel stored in the TN-68 dry casks is seven years (10 years for some fuel types), and Transnuclear would need to demonstrate, in an amendment request, that spent fuel that was cooled for a shorter period can be stored safely. The costs for Transnuclear to prepare such an amendment request and for the NRC review are not included in this regulatory analysis. The methodology used to estimate the capacity of the DSCs for spent fuel that has cooled for five years is subject to uncertainties resulting from decay heat and loading pattern restrictions. As a result, the actual DSC capacity may be higher or lower than those estimated.

### D.3.2.3.4 Dry Storage Upfront Costs

Upfront costs include engineering, design, and licensing costs; equipment costs; construction costs; and start up and testing costs. Each of these cost components are further described in EPRI TR-1021048, "Industry Spent Fuel Storage Handbook." As noted in EPRI TR-1025206, "Impacts Associated with Transfer of Spent Nuclear Fuel from Spent Fuel Storage Pools to Dry Storage after Five Years of Cooling, Rev. 1," the independent spent fuel storage installation

(ISFSI) upfront costs vary widely from site to site and the upfront costs for those in operation vary from several million to tens of millions of dollars. (EPRI TR-1025206, p. 2-23) Values for upfront costs were estimated based on two publically available cost estimates that identified the specified number of DSC to be stored. The estimate amortized upfront costs for each site is provided in Table 89.

**Table 89 Amortized DSC Upfront Costs**

ISFSI Facility	Upfront Cost Estimate (base year)	Upfront Cost Est. (2012 \$)	DSC Storage Capacity	Attributed Upfront Cost per DSC (2012 \$)
Monticello	\$21.5 million (2005 \$)	\$25,275,400	30	\$842,500
Pilgrim	\$22 million (2006\$)	\$25,055,800	53	\$472,800
Average (Best Estimate)		\$25,165,600		\$657,700

#### D.3.2.3.5 Incremental Costs Associated with Earlier DSC Purchase and Loading

Incremental costs are the costs associated with the purchase and loading of DSCs on a periodic basis. These costs include the capital costs for the DSC and the loading costs for the storage systems. The unit cost estimates used in this analysis are provided in Table 90. These cost estimates are based on the DSC unit costs that EPRI used for a Generic Interim Storage Facility (EPRI TR-1018722) and documented in EPRI TR-1025206. Operating nuclear power plants sites may experience incremental DSC purchase and loading costs that are higher or lower than the amount assumed in this analysis.

**Table 90 Incremental Unit Cost Estimates**

Item	Unit Cost (Constant \$2012)
Canister	\$780,000
Concrete overpack	\$208,000
Loading of canister-based storage	\$312,000
Total	\$1,300,000

#### D.3.2.3.6 Incremental Annual ISFSI Operating Costs

Annual operating costs for an ISFSI during reactor operation include the costs associated with NRC inspections; security; radiation monitoring; ISFSI operational monitoring; technical specification and regulatory compliance, including implementation of new certificate of compliance (CoC) amendments; personnel cost and code maintenance associated with fuel selection for dry storage; personnel costs for spent fuel management and fabrication surveillance activities; electric power usage for lighting and security systems; road maintenance to the ISFSI site; and miscellaneous expenses associated with ISFSI maintenance. NRC license fees for dry storage are included as part of the 10 CFR 50 operating license fees.

Because the reference plant has already implemented dry storage, there are no incremental annual ISFSI operating costs expected to implement dry storage at an earlier date if a policy decision is made to accelerate the transfer of spent fuel stored in spent fuel pools to dry storage. Annual operating costs are a function of when a company begins dry storage.

Therefore, incremental costs associated with annual ISFSI operating costs are insignificant for this analysis.

### D.3.2.3.7 Dry Storage Occupational Exposure (Routine)

Routine occupational exposure associated with dry storage of spent fuel includes worker dose associated with additional DSC loading, unloading and handling activities; additional ISFSI operations, maintenance, and surveillance activities; additional DSC storage at an ISFSI; and additional transportation cask loading, unloading, and handling activities.

Worker dose associated with DSC loading operations vary depending upon the cask technology being loaded, the characteristics of the fuel being loaded (e.g., fuel age and burnup), and fuel loading patterns in the DSC (e.g., the location of short-cooled, high burnup spent fuel or colder spent fuel within DSC baskets using regional loading). For the regulatory baseline, a worker dose of 400 person-mrem per DSC loaded was assumed. This radiation dose is consistent with that used in EPRI TR-1021049 and in EPRI TR-1018058, which analyzed worker impacts associated with loading spent fuel for transport to the proposed Yucca Mountain repository. Some sites achieve per package dose ranges in the range of 200 to 300 person-mrem per package loaded, while other sites experience higher per package dose rates. For the low-density storage case, each cask loaded in addition to the number required by the regulatory baseline is estimated to result in an incremental 400 person-mrem dose.

There is routine occupational dose associated with ISFSI annual operation and maintenance activities (i.e., inspection, surveillance, and security operations). The regulatory baseline assumes an annual dose of 120 person-mrem per site per year for inspection, surveillance, and security activities and 1,500 person-mrem per site per year for ISFSI operations and maintenance. These estimated radiation doses are consistent with assumptions used by EPRI in EPRI TR-1021049 and TR-1018058. Because additional shielding is assumed to be provided by concrete overpacks, the worker dose associated with ISFSI operations and maintenance is not expected to increase. Therefore, there is no incremental occupational dose predicted for performing annual ISFSI operation and maintenance.

There is routine occupational dose associated with the storage of each DSC at an operational ISFSI. The regulatory baseline assumes a worker dose of 170 person-mrem for each additional DSC loaded at an ISFSI site. This estimated radiation dose is consistent with assumptions used by EPRI in EPRI TR-1021049 and TR-1018058. Because additional shielding is assumed to be provided by concrete overpacks, the worker dose associated with each DSC stored at an operational ISFSI is not expected to increase. For the low-density spent fuel pool storage case, each cask stored in addition to the number required by the regulatory baseline is estimated to result in an incremental 170 person-mrem dose.

Table 91 summarizes the occupational dose estimates for each activity.

**Table 91 Incremental Occupational Dose (Routine) Estimates**

Activity	Incremental Occupational Dose (Routine) (person-mrem per activity)
Load a DSC	400
ISFSI Operation and maintenance	0
Loading a DSC at an ISFSI	170
Total	570

### D.3.2.3.8 Number of Dry Storage Casks

In 2012, the reference plant has 3,819 fuel assemblies stored in the spent fuel pool in a high-density 1x4 loading configuration. During each refueling outage, 284 assemblies are offloaded from the reactor vessel to the spent fuel pool. For the regulatory baseline, the plant is expected to load the required number of Transnuclear TN-68 DSCs with a 68-assembly capacity each refueling outage to retain sufficient space in the spent fuel pool to discharge one full core of fuel (full core reserve). The estimated inventory for use by this regulatory analysis is shown in Table 92.

**Table 92 Regulatory Baseline Loading of Dry Storage Casks**

Year	Initial SFP inventory	Refueling	Placed into dry storage	Final SFP Inventory	No. of casks loaded	Cask Capacity
2012	3055	284	-340	2999	5	68
2014	2999	284	-272	3011	4	68
2016	3011	284	-272	3023	4	68
2018	3023	284	-272	3035	4	68
2020	3035	284	-272	3047	4	68
2022	3047	284	-340	2991	5	68
2024	2991	284	-272	3003	4	68
2026	3003	284	-272	3015	4	68
2028	3015	284	-272	3027	4	68
2030	3027	284	-272	3039	4	68
2032	3039	284	-272	3051	4	68
2034	3051	764	0	3815	0	68
2040	3815	0	-816	2999	12	68
2041	2999	0	-816	2183	12	68
2042	2183	0	-816	1367	12	68
2043	1367	0	-680	687	10	68
2044	687	0	-687	0	11	68
Total number of casks					103	

At the expiration of the operating license in 2034, the full core is offloaded into the spent fuel pool. The analysis further assumes that the entire spent fuel pool inventory will gradually be placed into dry storage beginning in 2040 and completed by 2044, 10 years after termination of unit commercial operation.

For the low-density spent fuel pool storage case, it is assumed that there is an NRC policy decision that requires licensees to offload the spent fuel inventory to dry storage to obtain a low-density 1x4 with empties configuration within five years (e.g., by end of 2019). In this configuration, the reference plant spent fuel pool stores 852 assemblies (Spent Fuel Pool Study, Table 15). Using the same initial conditions as above, and using the DSC with a 57-assembly derated capacity beginning in year 2019, the inventory model is provided in Table 93.



**Table 93 Low-density Spent Fuel Pool Case Loading of Dry Storage Casks**

Year	Initial SFP inventory	Refueling	Placed into dry storage	Final SFP Inventory	No. of casks loaded	Cask Capacity
2012	3055	284	-340	2999	5	68
2013	2999	0	0	2999		
2014	2999	284	-544	2739	8	68
2015	2739	0	-544	2195	8	68
2016	2195	284	-544	1935	8	68
2017	1935	0	-544	1391	8	68
2018	1391	284	-544	1131	8	68
2019	1131	0	-285	846	5	57
2020	846	284	-285	845	5	57
2022	845	284	-285	844	5	57
2024	844	284	-285	843	5	57
2026	843	284	-285	842	5	57
2028	842	284	-285	841	5	57
2030	841	285	-285	841	5	57
2032	841	286	-285	842	5	57
2034	842	764	-798	808	14	57
2043	808	0	-408	400	6	68
2044	400	0	-400	0	6	68
Total number of casks					111	

At the expiration of the operating license in 2034, the full core is offloaded into the spent fuel pool. The analysis further assumes that the entire spent fuel pool inventory will gradually be placed into dry storage beginning in 2043 and completed by 2044, taking only two years because of the smaller remaining inventory. Additionally, in years 2038 and 2039, the spent fuel has cooled for a sufficient length of time that the DSC is no longer derated.

### D.3.3 Sensitivity Analysis

#### D.3.3.1 Present Value Calculations

Current trends in the marketplace have provided returns on investments well below the 3 percent and 7 percent discount rates, which OMB Circular No. A-4 is based. The NRC is providing a zero discount rate (e.g., undiscounted values) as a sensitivity analyses. Historically, regulatory analyses have provided the undiscounted values for the costs and benefits for information purposes, but have not provided them as a sensitivity analysis. However, the NRC is reporting the undiscounted costs and benefits as part of the sensitivity analysis based on current market trends and future predictions.

#### D.3.3.2 Dollar per Person-Rem Conversion Factor

The NRC is currently revising the dollar per person-rem averted conversion factor based on recent information regarding the value of a statistical life (VSL). However, until the NRC completes the update and publishes the appropriate guidance documents, the NRC will perform

sensitivity analysis to estimate the impact on the calculated results when more current VSL and cancer risk factor are used. The NRC used the U.S. Environmental Protection Agency's (EPA) VSL as an interim value in the sensitivity analysis. The EPA's VSL was developed through a rigorous process, reviewing many published academic papers, and includes review from the Scientific Advisory Board, an independent review board.

The EPA's VSL in 2009 dollars is approximately \$7.2 million.<sup>59</sup> The VSL is derived from "using a mixed effects model (random intercept with fixed effects for study characteristics), the authors regressed the VSL estimates on average income, probability of death, and several study design variables" (EPA, page 41). Therefore, using the CPI-U based inflator to adjust from 2009 dollars to 2012 dollars yields a VSL of approximately \$7.7 million. The International Commission on Radiation Protection (ICRP) updated the mortality risk factor in ICRP Publication No. 103, the updated risk coefficient is  $5 \times 10^{-4}$ . Using the updated ICRP risk coefficient and escalated EPA-based VSL, the dollar per person-rem conversion, rounded to the nearest thousand, is \$4,000 per person-rem.

Therefore, the NRC will provide the \$2,000 per person-rem conversion value for the recommendation and the \$4,000 per person-rem conversion value as a sensitivity analysis for this regulatory analysis.

#### **D.3.3.3 Replacement Energy Costs**

The NRC is currently updating its estimates for replacement energy costs based on a U.S. competitive electricity market area model. The updated model provides the replacement energy costs by day, week, and year, based on market area, in 2010 dollars. For each U.S. power market area, a lowest cost and highest cost replacement energy cost estimate was calculated, normalizing for reactor megawatt rating differences. The estimated replacement energy cost per reactor per year ranges from a high estimate of \$54.4 million to a low estimate of \$692,000 across all U.S. power markets. The average estimated cost per reactor per year across all U.S. power markets is \$9.6 million and the median estimated cost is \$6.4 million in 2010 dollars. Using the CPI-U inflator formula and the 2010 CPI-U inflator value from Table 77, the estimated replacement energy costs range from \$57.3 million to \$729,000 in 2012 dollars. The average estimated cost per reactor per year across all US power markets is \$10.1 million and the median estimated cost is \$6.7 million in 2012 dollars.

#### **D.3.3.4 Consequences Extending Beyond 50 Miles**

NUREG/BR-0184 states that in the case of nuclear power plants, changes in public health and safety from radiation exposure and offsite property impacts should be examined over a 50-mile distance from the plant site. However, in this circumstance it is beneficial for the analysis to include supplemental information (e.g., analyses and results) that go beyond the guidance provided in this document. The Spent Fuel Pool Study uses a plume release model that predicts slow deposition of aerosols. This results in public health consequences that extend beyond 50 miles from the postulated accident site. While the accuracy of the model decreases with distance, the amount of public exposure beyond 50 miles in the event of a release is expected to be significant. To capture effects beyond 50 miles, this regulatory analysis

---

<sup>59</sup> Environmental Protection Agency, National Center for Environmental Economics, "Valuing Mortality Risk Reductions for Environmental Policy: A White Paper", dated December 2010.

evaluates the public health and safety and economic consequences estimated by the plume model beyond the 50-mile distance from the plant site as a sensitivity analysis.

### D.3.4 Alternative – Low-Density Spent Fuel Pool Storage

#### D.3.4.1 Public Health (Accident)

This attribute measures expected changes in radiation exposure to the public due to change in accident frequencies or accident consequences associated with the proposed action. The expected changes in radiation exposure are predicted over a 50-mile radius from the plant site. The calculated radiation dose to the public is primarily from reoccupation of the land and other activities following the spent fuel pool accident. In addition, the calculated radiation dose to the public includes the occupational dose to workers for cleanup and decontamination of contaminated land not onsite. The incremental radiation doses are calculated by subtracting the values for the alternative from those of the regulatory baseline. The difference (delta) is the averted dose benefit of this alternative in units of person-rem. The quantitative results for public health (accident) considering the contribution of all initiators that could affect spent fuel pool risk is provided in Table 94. These values are based on the MACCS2 analyses and probabilistic considerations described in further detail in the Spent Fuel Pool Study and other referenced documents. The assumptions with regard to the release frequencies are discussed in section D.3.2.2.1 and with regard to the habitability criteria are found in section D.3.2.2.8 of this regulatory analysis.

**Table 94 Summary of Public Health (Accident) for Low-density Spent Fuel Pool Storage [All Initiators]**

Case	Dose (averted person-rem)			Benefits (2012 dollars)						
	Low Est.	Best Est.	High Est.	Undiscounted	3% Net Present Value			7% Net Present Value		
				Best Est.	Low Est.	Best Est.	High Est.	Low Est.	Best Est.	High Est.
Low-density storage	60	124	1,260	\$247,700	\$86,700	\$179,500	\$1,825,500	\$60,200	\$124,600	\$1,267,000

As Table 94 shows, the best estimate of the delta benefit for averted public health (accident) radiation exposure from a spent fuel pool accident, which results in spent fuel damage, is 124 person-rem. This dose represents the reduction of public health risk that results from a policy decision to transfer spent fuel from the spent fuel pool to dry storage in order to achieve low-density spent fuel loading in the pool at the reference plant. This value is based on a spent fuel pool accident that results in an averted delta dose exposure of approximately 5.6 person-rem per reactor-year over a remaining licensed lifetime of 22 years (until year 2034). The best estimate values are based on the reference site's population density of 722 people per square mile within a 50-mile radius from the site and result from the uncontrolled release of radionuclides from a full spent fuel pool. The low estimate case reflects the health benefit of a spent fuel pool with low-density storage compared to a pool with high-density storage if the more stringent Pennsylvania protective action guides are used following an event challenging spent fuel pool cooling. The high estimate case reflects the calculated health benefits that result if a less stringent 2 rem annual dose protective action guide is used.

A case to evaluate the sensitivity of the results to a change in the dollar per person-rem conversion value from \$2,000 to \$4,000 per person-rem averted was performed. The results of this case are provided in Table 95.

**Table 95 Sensitivity Analyses of Public Health (Accident) Benefits for Low-density Spent Fuel Pool Storage for All Initiating Events (within 50 miles)**

Case	Dose (averted person-rem)			Benefits (2012 dollars)						
	Low Est.	Best Est.	High Est.	Undiscounted	3% Net Present Value			7% Net Present Value		
				Best Est.	Low Est.	Best Est.	High Est.	Low Est.	Best Est.	High Est.
Dollar per person-rem value	60	124	1,260	\$495,500	\$173,400	\$358,900	\$3,650,900	\$120,400	\$249,100	\$2,534,000

Because a spent fuel pool fire under certain scenarios and environmental conditions could result in impacts to public health that extend beyond 50 miles, the next two cases evaluate the sensitivity of averted public health exposures extending beyond 50 miles from the site. The first sensitivity case extends the analysis beyond 50 miles from the plant site and uses the same low, best, and high estimate case assumptions for habitability described above and uses the standard \$2000 per person-rem conversion factor. The second sensitivity case evaluates the sensitivity of extending the analysis beyond 50 miles and uses a \$4,000 per person-rem conversion factor. Table 96 shows the sensitivity on public health (accident) benefits for these two cases.

**Table 96 Sensitivity Analyses of Public Health (Accident) Benefits for Low-density Spent Fuel Pool Storage for All Initiating Events (extending beyond 50 miles)**

Case	Dose (averted person-rem)			Benefits (2012 dollars)						
	Low Est.	Best Est.	High Est.	Undiscounted	3% Net Present Value			7% Net Present Value		
					Low Est.	Best Est.	High Est.	Low Est.	Best Est.	High Est.
Base case extended beyond 50 miles	541	892	7,868	\$1,783,450	\$783,250	\$1,291,900	\$11,399,100	\$543,650	\$896,700	\$7,911,700
Dollar per person-rem value	541	892	7,868	\$3,566,900	\$1,566,500	\$2,583,800	\$22,798,200	\$1,087,300	\$1,793,400	\$15,823,400

#### D.3.4.2 Occupational Health (Accident)

Occupational health measures both short-term and long-term health effects associated with site workers as a result of changes in accident frequency or accident mitigation. Within the regulatory baseline, the short-term occupational exposure related to the accident occurs at the time of the accident and during the immediate management of the emergency and during decontamination and decommissioning of the onsite property. The radiological occupational exposure resulting from cleanup and refurbishment or decommissioning activities of the damaged facility to occupational workers are estimated within the long-term occupational exposure. The quantitative results for occupational health (accident) considering the contribution of all initiators that could affect spent fuel pool risk is provided in Table 97 and is based on the release frequencies discussed in section D.3.2.2.1 and the occupational health (accident) assumptions found in section D.3.2.2.7.

**Table 97 Occupational Health (Accident) Benefits for Low-density Spent Fuel Pool Storage Considering All Initiating Events**

Case	Dose (averted person-rem)			Benefits (2012 dollars)						
	Low Est.	Best Est.	High Est.	Undiscounted	3% Net Present Value			7% Net Present Value		
				Best Est.	Low Est.	Best Est.	High Est.	Low Est.	Best Est.	High Est.
short-term	0.3	0.4	5.5	\$841	\$388	\$628	\$7,959	\$269	\$453	\$5,524
long-term	0.1	0.2	5.2	\$415	\$98	\$310	\$7,490	\$68	\$223	\$5,198
Total	0.3	0.6	10.7	1,260	490	940	15,450	340	680	10,720

As Table 97 shows, the total delta benefit for short- and long-term occupational health (accident) is 0.6 person-rem averted per reactor. The estimated total benefit of the occupational health (accident) attribute for low-density spent fuel pool storage relative to the regulatory baseline, using the \$2,000 per person-rem averted conversion factor, net present value ranges are insignificant for this analysis and do not warrant further sensitivity analysis.

### D.3.4.3 Occupational Health (Routine)

Occupational health (routine) accounts for radiological exposures to workers during normal facility operations (i.e., non-accident situations). These occupational exposures occur during DSC loading and handling activities, ISFSI operations, and maintenance and surveillance activities. The assumptions in relation to the exposures for occupational health (routine) are found in section D.3.2.3.7 of this regulatory analysis.

**Table 98 Occupational Health (Routine) Costs for Low-density Spent Fuel Pool Storage**

Year	No. of DSCs			Dose (person-rem)		Costs (2012 dollars)		
	Low-Density SFP Loading	Regulatory Baseline	Difference	Exposure per DSC	Additional Dose	No Discount	3% NPV	7% NPV
2012	5	5	0	0.57	0	\$0	\$0	\$0
2013	0	0	0	0.57	0	\$0	\$0	\$0
2014	8	4	-4	0.57	-2.28	-\$4,560	-\$4,298	-\$3,983
2015	8	0	-8	0.57	-4.56	-\$9,120	-\$8,346	-\$7,445
2016	8	4	-4	0.57	-2.28	-\$4,560	-\$4,052	-\$3,479
2017	8	0	-8	0.57	-4.56	-\$9,120	-\$7,867	-\$6,502
2018	8	4	-4	0.57	-2.28	-\$4,560	-\$3,819	-\$3,039
2019	5	0	-5	0.57	-2.85	-\$5,700	-\$4,635	-\$3,550
2020	5	4	-1	0.57	-0.57	-\$1,140	-\$900	-\$663
2022	5	5	0	0.57	0	\$0	\$0	\$0
2024	5	4	-1	0.57	-0.57	-\$1,140	-\$800	-\$506
2026	5	4	-1	0.57	-0.57	-\$1,140	-\$754	-\$442
2028	5	4	-1	0.57	-0.57	-\$1,140	-\$710	-\$386
2030	5	4	-1	0.57	-0.57	-\$1,140	-\$670	-\$337
2032	5	4	-1	0.57	-0.57	-\$1,140	-\$631	-\$295
2034	14	0	-14	0.57	-7.98	-\$15,960	-\$8,329	-\$3,602
2040		12	12	0.57	6.84	\$13,680	\$5,979	\$2,058
2041		12	12	0.57	6.84	\$13,680	\$5,805	\$1,923
2042		12	12	0.57	6.84	\$13,680	\$5,636	\$1,797
2043	6	10	4	0.57	2.28	\$4,560	\$1,824	\$560
2044	6	11	5	0.57	2.85	\$5,700	\$2,214	\$654
				<b>Total:</b>	<b>-4.56</b>	<b>-\$9,000</b>	<b>-\$24,000</b>	<b>-\$27,000</b>

As Table 98 shows, the delta benefit for occupational health (routine) is an increase of 4.56 person-rem in worker exposure resulting from DSC loading and handling activities; ISFSI operations; and maintenance and surveillance activities. The estimated cost to the occupational health (routine) for low-density spent fuel storage relative to the regulatory baseline and calculated in accordance with the current regulatory framework, ranges from \$24,000 (3 percent net present value) to \$27,000 (7 percent net present value) using the \$2,000 per person-rem averted conversion factor. These ranges are insignificant for this analysis and do not warrant further sensitivity analysis.

### D.3.4.4 Offsite Property

The offsite property attribute measures the expected total monetary effects on offsite property resulting from the proposed action. Changes to offsite property can take various forms, both direct, (e.g. land, food, and water) and indirect (e.g. tourism). This attribute is the product of the change in accident frequency and the property consequences from the occurrence of a spent fuel pool accident at the reference plant.

For the regulatory baseline, the offsite property costs are any property consequences resulting from any radiological release from the occurrence of an accident. Normal operational releases and any plant releases not related to the severe accident analyzed are outside the scope of this regulatory analysis.

The cost offsets for the analyzed spent fuel pool accident are quantified relative to the regulatory baseline based on the MACCS2 calculation results and probabilistic considerations provided in the main document. The results for the consequences from a low-density spent pool accident are compared to those from the regulatory baseline spent fuel pool accident. The calculation is the difference between the calculated consequences resulting from a low-density and a high-density spent fuel pool accident and are provided in Table 99.

**Table 99 Offsite Property Cost Offsets for Low-density Spent Fuel Pool Storage**

Case	Offsite Property Cost Offsets (2012 dollars)						
	Undiscounted	3% Net Present Value			7% Net Present Value		
	Best Est.	Low Est.	Best Est.	High Est.	Low Est.	Best Est.	High Est.
Base case, consequences within 50 miles	\$723,300	\$777,500	\$524,000	\$3,323,400	\$539,700	\$363,700	\$2,306,700
Sensitivity study, consequences extend beyond 50 miles	\$2,139,300	\$3,599,100	\$1,549,700	\$8,393,400	\$2,498,000	\$1,075,600	\$5,825,500

As Table 99 shows the estimate of offsite property damage can vary significantly with the criterion used to measure or estimate the level of contamination. This regulatory analysis uses three protective action levels – the Pennsylvania PAG of 500 mrem annually for the low estimate, the EPA intermediate phase PAG level of 2 rem in the first year, and 500 mrem annually thereafter for the best estimate, and 2 rem annually for the high estimate – to evaluate post-accident collective dose and offsite property costs. As discussed in section D.3.2.2.8, offsite property costs are inversely proportional to changes in collective dose resulting from changes in habitability criteria (i.e., lower PAG guidelines result in lower collective dose value and higher offsite property costs). Furthermore, the high estimate is also affected by the bounding assumption used in establishing the high estimate spent fuel pool release frequency shown in Table 75. As shown in Table 99 the estimated total cost offsets for the low-density storage option relative to the regulatory baseline range from \$0.5 to \$3.3 million (3 percent net present value) and from \$0.4 to \$2.3 million (7 percent net present value) considering consequences within 50 miles from the site. As a sensitivity study, the analysis of potential consequences was extended beyond 50 miles from the site and were quantified based on the MACCS2 model. These estimate results are also shown in Table 99 and result in cost offsets approximately 2.5 to 4.6 times greater than those in the base case result.

This analysis does not address potential changes to current methodologies and tools to regulatory analysis guidance that may result from applying SOARCA insights and improving guidance and analysis tools (such as the MACCS2 computer code) based on up-to-date data in

addition to advancements in accident consequence assessment knowledge as it relates to this attribute.

#### D.3.4.5 Onsite Property

This attribute measures the expected monetary effects on onsite property, including replacement power costs, decontamination, and refurbishment costs, from the proposed action. There are two forms of onsite property costs that each alternative must disposition. The first type of onsite property costs are the cleanup and decontamination costs for the unit. The second type of onsite property costs is the cost to replace the energy from the damaged or shutdown unit(s). The cost offsets for low-density spent fuel pool storage are quantified relative to the regulatory baseline based on the probabilistic considerations provided in the main document and the onsite property estimates described in section D.3.2.2.5.

As stated in section D.3.2.2.6, another unit is co-located on the reference plant's site. Therefore, both units may not operate (e.g., due to significant site damage or contamination resulting in high occupational exposure to the undamaged unit) due to the spent fuel pool accident. In modeling the replacement energy costs based on this scenario, it is assumed for the high estimate that replacement energy would be purchased for both units.

Based on these modeling assumptions, the onsite property results are provided in Table 100.

**Table 100 Summary of Onsite Property Cost Offsets for Low-density Spent Fuel Pool Storage**

Case	Onsite Property Cost Offsets (2012 dollars)						
	Undiscounted	3% Net Present Value			7% Net Present Value		
	Best Est.	Low Est.	Best Est.	High Est.	Low Est.	Best Est.	High Est.
Onsite Property - Replacement Energy	\$1,639	\$50	\$1,091	\$117,100	\$30	\$682	\$73,200
Onsite Property - Cleanup, Decontamination, Repair, & Refurbishment	\$8,800	\$2,900	\$5,800	\$132,500	\$1,800	\$3,600	\$82,600
Total	\$10,440	\$2,950	\$6,890	\$249,600	\$1,830	\$4,280	\$155,800

As Table 100 shows, based on these calculations, the delta cost offset for probability weighted onsite property best estimate ranges from \$6,890 (3 percent net present value) to \$4,280 (7 percent net present value). Low and high estimates are also provided in Table 100.

#### D.3.4.6 Industry Implementation

Industry implementation accounts for the projected net economic effect on the affected licensees to implement the mandated changes. Costs evaluated for dry storage include upfront and incremental DSC capital and loading costs. Additional costs above the regulatory baseline are considered negative and cost savings are considered positive. The quantitative results for industry implementation are given in terms of expected costs if a policy decision is made to accelerate the transfer of spent fuel stored in spent fuel pools to dry storage. These expected costs are not frequency weighted. Assumptions used for developing the industry implementation cost model are discussed in sections D.3.2.3.2, D.3.2.3.5, and D.3.2.3.6, with the results provided in Table 101.



**Table 101 Industry Implementation Cost Model for Low-density Spent Fuel Pool Storage**

Year	No. of DSCs			Unit Costs			Costs (2012 dollars)		
	Low-Density	Regulatory Baseline	Difference	One Time ISFSI Mod	Upfront costs per	DSC Purchase and Loading	No Discount	3% NPV	7% NPV
2012	5	5	0		\$657,632	\$1,300,000	\$0	\$0	\$0
2013	0	0	0		\$657,632	\$1,300,000	\$0	\$0	\$0
2014	8	4	-4		\$657,632	\$1,300,000	-\$7,830,528	-\$7,381,024	-\$6,839,486
2015	8	0	-8		\$657,632	\$1,300,000	-\$15,661,056	-\$14,332,085	-\$12,784,087
2016	8	4	-4		\$657,632	\$1,300,000	-\$7,830,528	-\$6,957,323	-\$5,973,872
2017	8	0	-8		\$657,632	\$1,300,000	-\$15,661,056	-\$13,509,364	-\$11,166,116
2018	8	4	-4		\$657,632	\$1,300,000	-\$7,830,528	-\$6,557,944	-\$5,217,811
2019	5	0	-5		\$657,632	\$1,300,000	-\$9,788,160	-\$7,958,670	-\$6,095,574
2020	5	4	-1		\$657,632	\$1,300,000	-\$1,957,632	-\$1,545,373	-\$1,139,360
2022	5	5	0		\$657,632	\$1,300,000	\$0	\$0	\$0
2024	5	4	-1		\$657,632	\$1,300,000	-\$1,957,632	-\$1,373,044	-\$869,212
2026	5	4	-1		\$657,632	\$1,300,000	-\$1,957,632	-\$1,294,225	-\$759,203
2028	5	4	-1		\$657,632	\$1,300,000	-\$1,957,632	-\$1,219,932	-\$663,118
2030	5	4	-1		\$657,632	\$1,300,000	-\$1,957,632	-\$1,149,902	-\$579,193
2032	5	4	-1		\$657,632	\$1,300,000	-\$1,957,632	-\$1,083,893	-\$505,889
2034	14	0	-14		\$657,632	\$1,300,000	-\$27,406,848	-\$14,303,428	-\$6,186,086
2040	0	12	12		\$657,632	\$1,300,000	\$23,491,584	\$10,267,625	\$3,533,186
2041	0	12	12		\$657,632	\$1,300,000	\$23,491,584	\$9,968,568	\$3,302,043
2042	0	12	12		\$657,632	\$1,300,000	\$23,491,584	\$9,678,222	\$3,086,022
2043	6	10	4		\$657,632	\$1,300,000	\$7,830,528	\$3,132,111	\$961,377
2044	6	11	5		\$657,632	\$1,300,000	\$9,788,160	\$3,801,105	\$1,123,105
		<b>Total:</b>	<b>-8</b>			<b>Total:</b>	<b>-\$15,660,000</b>	<b>-\$41,820,000</b>	<b>-\$46,770,000</b>

For this analysis, the Transnuclear TN-68 dry casks are evaluated for the best estimate because the reference plant's ISFSI for dry cask storage utilizes the TN-68 cask design as discussed in Section 1.3 of the main report. The results provided in Table 102 show that eight additional DSCs are needed to store the hotter spent fuel.

**Table 102 Industry Implementation Costs for Low-density Spent Fuel Pool Storage**

Case	Costs (2012 dollars)		
	No Discount	3% Net Present Value	7% Net Present Value
Industry Implementation	-\$15,660,000	-\$41,820,000	-\$46,770,000

Table 102 shows, the incremental costs associated with DSC upfront costs and the earlier purchasing and loading of DSCs on a periodic basis. The estimated industry implementation costs for low-density spent fuel storage relative to the regulatory baseline and calculated in accordance with the current regulatory framework, ranges from \$41.8 million (3 percent net present value) to \$46.8 million (7 percent net present value).

**D.3.4.7 Industry Operation**

Industry operation accounts for the projected net economic effect due to routine and recurring activities required by the proposed alternative. Annual operating costs for an ISFSI during reactor operation include the costs associated with NRC inspections; security; radiation



monitoring; ISFSI operational monitoring; technical specification and regulatory compliance, including implementation of new certificate of compliance (CoC) amendments; personnel cost and code maintenance associated with fuel selection for dry storage; personnel costs for spent fuel management and fabrication surveillance activities; electric power usage for lighting and security systems; road maintenance to the ISFSI site; and miscellaneous expenses associated with ISFSI maintenance. NRC license fees for dry storage are included as part of the 10 CFR 50 operating license fees. As discussed in section D.3.2.3.6, incremental costs associated with annual ISFSI operating costs are insignificant for this analysis.

Industry operation also includes annual operating costs following reactor shutdown for decommissioning, which includes the costs associated with transporting spent fuel offsite. These costs were beyond the scope of the evaluation of expedited transfer of spent fuel to dry cask storage and are not included in this analysis.

#### **D.3.4.8 NRC Implementation**

These costs, if calculated, would further reduce the calculated net benefit for this reference plant regulatory and backfit analysis.

#### **D.3.4.9 NRC Operation**

These costs, if calculated, would further reduce the calculated net benefit for this reference plant regulatory and backfit analysis.

#### **D.3.4.10 Other Considerations**

##### **D.3.4.10.1 Modeling Uncertainties**

There remain significant uncertainties in estimating the frequency of events for natural phenomena, which are postulated to challenge spent fuel pool cooling or integrity. There are also significant uncertainties in the calculation of event consequences in terms of the dispersion and disposition of radioactive material into the site environs. This is due in part to significant uncertainties regarding the degree to which topographical features and other phenomena are modeled at distances away from the reference plant. Estimating economic consequences also includes large uncertainties, as it is difficult to model the impact of disruptions to many different aspects of local economies and the loss of infrastructure on the general U.S. economy. An example of this is the supply chain disruptions that followed the 2011 Tohoku earthquake and subsequent tsunami on Japan or the 2004 Indian Ocean earthquake and tsunami on Thailand.

##### **D.3.4.10.2 Cask Handling Risk**

The NRC recognizes that there are costs and risks associated with the handling and movement of spent fuel casks in the reactor building. These cost and risk impacts, if included in this analysis, would further reduce the overall net benefit in relation to the regulatory baseline. These effects (e.g., the added risks of handling and moving casks) were conservatively ignored in order to calculate the maximum potential benefit by only comparing the safety of high-density fuel pool storage relative to low-density fuel pool storage and its implementation costs without consideration of cask movement risk.

### D.3.4.10.3 Mitigating Strategies

The release of fission products to the environment from events that may cause the loss of spent fuel pool cooling or integrity, such as seismic events, missiles, heavy load drops, loss of cooling or make-up, inadvertent drainage or siphoning and pneumatic seal failures, are estimated to be approximately  $5.5 \times 10^{-7}$  per reactor-year without successful mitigation. Operator diagnosis and recovery are important factors considered in the development of the event frequencies for these events and portions of this evaluation are premised on licensees having taken appropriate actions to understand the potential consequences of spent fuel pool accident events and develop appropriate procedures and mitigating strategies to respond and mitigate the consequences.

The main report evaluated the potential benefits of mitigation measures required under Title 10, Code of Federal Regulations (10 CFR), Part 50.54 (hh)(2), which were implemented following the September 11, 2001 attacks. These mitigation measures are intended to maintain spent fuel pool cooling in the event of a loss of large areas of the plant due to explosions or fire. The main report does not consider the post-Fukushima improvements required by NRC and being implemented by the plants. These improvements are intended to increase the likelihood of restoring or maintaining power and mitigation capability during severe accidents.

The new spent fuel pool level instrumentation required under Order EA-12-051 and the mitigation strategies now required under Order EA-12-049, significantly enhance the likelihood of successful mitigation because of the following features:

- Portable equipment with redundant sets (e.g., N+1) that is sufficient to supply all functions, simultaneously for the entire site, including equipment for the spent fuel pool. This portable equipment provides additional protection from seismic events, which are a dominant contributor to spent fuel pool risk.
- The mission time for this equipment is indefinite, versus the 12-hour mission time for the 50.54(hh)(2) equipment.<sup>60</sup>
- The new EA-12-049 mitigating strategies are capable of being deployed in all modes, which means that the new strategies can address spent fuel pool cooling issues that could occur in any operating cycle phase.
- The new spent fuel pool level instrumentation required under Order EA-12-051, ensures a reliable indication of the water level in the spent fuel pool for identification of the following pool water level conditions:
  - A level that is adequate to support operation of the normal fuel pool cooling system
  - A level that is adequate to provide substantial radiation shielding for a person standing on the spent fuel pool operating deck, and
  - A level where fuel remains covered and actions to implement make-up water addition should no longer be deferred.

---

<sup>60</sup> This section of the regulations deals with the development and implementation of guidance and strategies intended to maintain or restore core cooling, containment, and SFP cooling capabilities under the circumstances associated with loss of large areas of the plant resulting from explosions or fire.

- The minimum spent fuel pool makeup flow rate under Order EA-12-049 is set to match the design basis heat load for the spent fuel pool, which is typically a full core offload in addition to the recently removed fuel from the last refueling outage. This results in a lower flow rate than that in NEI guidance for Part 50.54 (hh)(2) equipment and an earlier transition to spray, if necessary, due to leaks.
- The method of filling the spent fuel pool is via a connection to the normal spent fuel pool makeup system located away from the spent fuel pool floor, reducing the impacts on human performance due to potentially adverse environmental conditions (e.g., high temperature, humidity, and radiation) following an event.

This additional equipment, strategies, and features provided by Orders EA-12-049 and EA-12-051, provide additional accident mitigation capability and would further enhance the likelihood of successful mitigation, thereby further reducing the value for the conditional probability of release.

#### **D.3.4.10.4 Other Favorable Spent Fuel Loading Configurations**

In section 9.2 of the Spent Fuel Pool Study, a sensitivity analysis is provided in which a more favorable fuel pattern is considered. In this more favorable pattern, eight cold assemblies surround each hot assembly (i.e., 1x8 fuel assembly pattern). Although only a few sensitivity analysis were performed using this configuration, the results are promising. The sensitivity calculations for the high-density 1x8 fuel pattern showed a shorter time to air coolability (i.e. no releases in OCP3). Even for the cases that led to the release of radioactive materials in OCP2, the release magnitude was much smaller than for the 1x4 fuel pattern, and comparable to the low-density cases. Furthermore, the high-density loading configuration, which allows for 764 empty cells for a full core offload may result in similar reductions in risk to the low-density storage option evaluated without the significant capital costs for implementation. Further evaluation of this alternative and possibly other loading configurations for all operating cycle phases is recommended.

### **D.4 PRESENTATION OF RESULTS**

This section presents the analytical results, including discussion of supplemental considerations, uncertainties in estimates, and results of sensitivity analyses on the overall benefits. The results are presented in two different ways, in order to address the differing decision criteria between regulatory analyses and backfit analyses (10 CFR 50.109).

#### **D.4.1 Regulatory Analysis**

##### **D.4.1.1 Summary Table**

Table 103 summarizes the quantified net benefits used to perform a safety goal screening.

**Table 103 Summary of Net Benefits for Low-density Spent Fuel Pool Storage Considering All Initiator Events (within 50 miles)**

Attribute	Best Estimate			Low Estimate			High Estimate		
	Undiscounted	3% NPV	7% NPV	Undiscounted	3% NPV	7% NPV	Undiscounted	3% NPV	7% NPV
Public Health (Accident)	\$247,700	\$179,500	\$124,600	\$119,700	\$86,700	\$60,200	\$2,520,000	\$1,825,500	\$1,267,000
Occupational Health (Accident)	\$1,300	\$900	\$700	\$700	\$500	\$300	\$21,300	\$15,400	\$10,700
Offsite Property	\$723,300	\$524,000	\$363,700	\$1,073,300	\$777,500	\$539,700	\$4,587,800	\$3,323,400	\$2,306,700
Onsite Property	\$10,400	\$6,900	\$4,300	\$4,480	\$2,950	\$1,830	\$378,600	\$249,600	\$155,800
<b>Total Benefits</b>	<b>\$982,700</b>	<b>\$711,300</b>	<b>\$493,300</b>	<b>\$1,198,200</b>	<b>\$867,700</b>	<b>\$602,000</b>	<b>\$7,507,700</b>	<b>\$5,413,900</b>	<b>\$3,740,200</b>
Occupational Health (Routine)	-\$9,000	-\$24,000	-\$27,000	-\$9,000	-\$24,000	-\$27,000	-\$9,000	-\$24,000	-\$27,000
Industry Implementation	-\$15,660,000	-\$41,820,000	-\$46,770,000	-\$15,660,000	-\$41,820,000	-\$46,770,000	-\$15,660,000	-\$41,820,000	-\$46,770,000
Industry Operation	-\$730,000	-\$252,000	-\$64,000	-\$730,000	-\$252,000	-\$64,000	-\$730,000	-\$252,000	-\$64,000
NRC Implementation	nc	nc	nc	nc	nc	nc	nc	nc	nc
NRC Operation	nc	nc	nc	nc	nc	nc	nc	nc	nc
<b>Total Costs</b>	<b>-\$16,399,000</b>	<b>-\$42,096,000</b>	<b>-\$46,861,000</b>	<b>-\$16,399,000</b>	<b>-\$42,096,000</b>	<b>-\$46,861,000</b>	<b>-\$16,399,000</b>	<b>-\$42,096,000</b>	<b>-\$46,861,000</b>
<b>Net Benefit</b>	<b>-\$15,416,000</b>	<b>-\$41,385,000</b>	<b>-\$46,368,000</b>	<b>-\$15,200,800</b>	<b>-\$41,228,300</b>	<b>-\$46,259,000</b>	<b>-\$8,891,300</b>	<b>-\$36,682,100</b>	<b>-\$43,120,800</b>

1. nc = not calculated
2. Results are expressed in current dollars (year 2012 dollars) except for the undiscounted cases, which are expressed in constant dollars.

As shown in Table 103, the calculated net benefits for requiring low-density spent fuel pool storage at the reference plant does not achieve a positive net benefit using the current regulatory framework. This means that the calculated licensee costs to implement a low-density spent fuel pool storage alternative at the referenced site outweighs the estimated benefits.

Furthermore, for the seismic event analyzed for the Spent Fuel Pool Study, no offsite early fatalities are calculated to occur. This result is expected for two main reasons:

1. In comparison to reactors, spent fuel pools have a larger proportion of longer-lived radionuclides, which are less likely to cause the significant doses required for acute health effects.
2. Despite the large releases for certain predicted spent fuel pool accident progressions, the release from the most recently discharged fuel (which contains the shorter-lived radionuclides) is predicted to be insufficiently fast and insufficiently large to reach the acute thresholds associated with offsite early fatalities. When doses do exceed minimum levels for early fatalities, emergency response, as treated in the main report, effectively prevents any early fatality risk, at least in part because the modeled accident progression results in releases that are long compared with the time needed for relocation.

In addition, the predicted long-term exposure of the population, which could result in latent cancer fatality risk, is also low for the following reasons:

1. The individual latent individual latent cancer fatality risk within 0-10 miles for the studied scenarios is predicted to be on the order of  $10^{-10}$  to  $10^{-11}$  per year, based on the linear no threshold (LNT) dose response model.
2. The risk within 10 miles of the analyzed accident is dominated by low dose received at a low dose rate. According to alternate dose response models, excluding the uncertain effects of low radiation dose could reduce the quantified individual latent cancer fatality risk within 10 miles to be approximately  $10^{-14}$  per year, a reduction of approximately 3,000 times.

3. Average individual latent cancer fatality risk is low and decreases slowly as a function of distance from the plant. Additionally, the predicted individual risks latent cancer fatalities are dominated by long-term exposures to very lightly contaminated areas for which doses are small enough to be considered habitable. Therefore, the use of alternate dose response models would significantly reduce the quantified latent cancer fatalities by at least an order of magnitude.

#### D.4.1.2 Implementation and Operation Costs

**Table 104 Summary of Total Implementation and Operation Costs for Low-density Spent Fuel Pool Storage for All Initiator Events**

Attribute	Costs (2012 dollars in millions)	
	3% Net Present Value	7% Net Present Value
Occupational Health (Routine)	\$0.024	\$0.027
Industry Implementation	\$41.800	\$46.770
Industry Operation	\$0.252	\$0.064
NRC Implementation	nc	nc
NRC Operation	nc	nc
Total	\$42.096	\$46.861

As shown in Table 104, the total estimated costs for the referenced plant unit to achieve and maintain a low-density spent fuel pool loading range from \$42 million (3 percent net present value) to \$47 million (7 percent net present value). These costs are dominated by the capital costs for the DSCs and the loading costs for the storage systems to achieve low-density storage in the spent fuel pool than that required for the regulatory baseline.

#### D.4.1.3 Total Benefits and Cost Offsets

**Table 105 Summary of Total Benefits and Cost Offsets for Low-Density Spent Fuel Pool Storage for All Initiator Events**

Attribute	Benefits and Cost Offsets (2012 dollars in millions)		
	Undiscounted	3% Net Present Value	7% Net Present Value
Public Health (Accident)	\$0.12 to \$2.52	\$0.09 to \$1.83	\$0.06 to \$1.27
Occupational Health (Accident)	\$0.001 to \$0.021	\$0.0005 to \$0.015	\$0.0003 to \$0.011
Offsite Property	\$0.72 to \$4.59	\$0.52 to \$3.32	\$0.36 to \$2.31
Onsite Property	\$0.004 to \$0.38	\$0.003 to \$0.25	\$0.002 to \$0.16
Total	\$0.85 to \$7.51	\$0.61 to \$5.42	\$0.42 to \$3.75

The total benefits, which include the public health (accident) and occupational health (accident) is summed with the cost offsets, which include offsite property and onsite property relative to the regulatory baseline, are shown in the Table 105. The offsite property cost offset is the largest contributor to the benefits, of which the majority of those costs occur during the long-term phase.

#### D.4.1.4 Sensitivity Analysis

This section summarizes the results of the sensitivity analyses that were performed as an additional consideration in performing safety goal screening for requiring low-density spent fuel pool storage at the reference plant.

#### D.4.1.4.1 Dollar per Person-Rem Conversion Factor

The NRC is currently revising the dollar per person-rem averted conversion factor based on recent information regarding the value of a statistical life. However, until the NRC completes the update and publishes the appropriate guidance documents, the NRC performs sensitivity analysis to estimate the impact on the calculated results when more current VSL and cancer risk factor are used. The NRC used the U.S. Environmental Protection Agency's (EPA) VSL as an interim value in the sensitivity analysis as described in section D.3.3.2. The affect of this variable on the calculated results are provided in Table 106.

**Table 106 Dollar Per Person-Rem Sensitivity Analysis of Net Benefits for Low-density Spent Fuel Pool Storage Considering All Initiating Events (within 50 miles)**

Attribute	Best Estimate			Low Estimate			High Estimate		
	Undiscounted	3% NPV	7% NPV	Undiscounted	3% NPV	7% NPV	Undiscounted	3% NPV	7% NPV
Public Health (Accident)	\$495,400	\$359,000	\$249,200	\$239,400	\$173,400	\$120,400	\$5,040,000	\$3,651,000	\$2,534,000
Occupational Health (Accident)	\$2,600	\$1,800	\$1,400	\$1,400	\$1,000	\$600	\$42,600	\$30,800	\$21,400
Offsite Property	\$723,300	\$524,000	\$363,700	\$1,073,300	\$777,500	\$539,700	\$4,587,800	\$3,323,400	\$2,306,700
Onsite Property	\$10,400	\$6,900	\$4,300	\$4,480	\$2,950	\$1,830	\$378,600	\$249,600	\$155,800
<b>Total Benefits</b>	<b>\$1,231,700</b>	<b>\$891,700</b>	<b>\$618,600</b>	<b>\$1,318,600</b>	<b>\$954,900</b>	<b>\$662,500</b>	<b>\$10,049,000</b>	<b>\$7,254,800</b>	<b>\$5,017,900</b>
Occupational Health (Routine)	-\$18,000	-\$48,000	-\$54,000	-\$18,000	-\$48,000	-\$54,000	-\$18,000	-\$48,000	-\$54,000
Industry Implementation	-\$15,660,000	-\$41,820,000	-\$46,770,000	-\$15,660,000	-\$41,820,000	-\$46,770,000	-\$15,660,000	-\$41,820,000	-\$46,770,000
Industry Operation	-\$730,000	-\$252,000	-\$64,000	-\$730,000	-\$252,000	-\$64,000	-\$730,000	-\$252,000	-\$64,000
NRC Implementation	nc	nc	nc	nc	nc	nc	nc	nc	nc
NRC Operation	nc	nc	nc	nc	nc	nc	nc	nc	nc
<b>Total Costs</b>	<b>-\$16,408,000</b>	<b>-\$42,120,000</b>	<b>-\$46,888,000</b>	<b>-\$16,408,000</b>	<b>-\$42,120,000</b>	<b>-\$46,888,000</b>	<b>-\$16,408,000</b>	<b>-\$42,120,000</b>	<b>-\$46,888,000</b>
<b>Net Benefit</b>	<b>-\$15,176,000</b>	<b>-\$41,228,000</b>	<b>-\$46,269,000</b>	<b>-\$15,089,400</b>	<b>-\$41,165,100</b>	<b>-\$46,225,500</b>	<b>-\$6,359,000</b>	<b>-\$34,865,200</b>	<b>-\$41,870,100</b>

1. nc = not calculated
2. Results are expressed in current dollars (year 2012 dollars) except for the undiscounted cases, which are expressed in constant dollars.

As shown in Table 106, the dollar per person-rem sensitivity analysis does not achieve a positive net benefit when using a person-rem conversion factor twice as large as the conversion factor in NUREG-1530.

#### D.4.1.4.2 Consequences Extending Beyond 50 Miles

The RA Handbook states that in the case of nuclear power plants, changes in public health and safety from radiation exposure and offsite property impacts should be examined over a 50-mile distance from the plant site, although alternative distances from the plant may be used for sensitivity analyses. For this regulatory analysis, supplemental information (e.g., analyses and results) based on MACCS2 calculated results, which extends the analysis beyond 50 miles from the postulated accident site is provided in Table 107.

**Table 107 Consequences Extending Beyond 50 Miles Sensitivity Analysis of Net Benefits for Low-density Spent Fuel Pool Storage Considering All Initiating Events**

Attribute	Best Estimate			Low Estimate			High Estimate		
	Undiscounted	3% NPV	7% NPV	Undiscounted	3% NPV	7% NPV	Undiscounted	3% NPV	7% NPV
Public Health (Accident)	\$1,783,400	\$1,291,900	\$896,700	\$1,081,200	\$783,300	\$543,600	\$15,735,800	\$11,399,100	\$7,911,700
Occupational Health (Accident)	\$1,300	\$900	\$700	\$700	\$500	\$300	\$21,300	\$15,400	\$10,700
Offsite Property	\$2,139,300	\$1,549,700	\$1,075,600	\$4,968,300	\$3,599,100	\$2,498,000	\$11,586,600	\$8,393,400	\$5,825,500
Onsite Property	\$10,400	\$6,900	\$4,300	\$4,680	\$3,150	\$2,030	\$378,600	\$249,600	\$155,800
<b>Total Benefits</b>	<b>\$3,934,400</b>	<b>\$2,849,400</b>	<b>\$1,977,300</b>	<b>\$6,054,900</b>	<b>\$4,386,100</b>	<b>\$3,043,900</b>	<b>\$27,722,300</b>	<b>\$20,057,500</b>	<b>\$13,903,700</b>
Occupational Health (Routine)	-\$9,000	-\$24,000	-\$27,000	-\$9,000	-\$24,000	-\$27,000	-\$9,000	-\$24,000	-\$27,000
Industry Implementation	-\$15,660,000	-\$41,820,000	-\$46,770,000	-\$15,660,000	-\$41,820,000	-\$46,770,000	-\$15,660,000	-\$41,820,000	-\$46,770,000
Industry Operation	-\$730,000	-\$252,000	-\$64,000	-\$730,000	-\$252,000	-\$64,000	-\$730,000	-\$252,000	-\$64,000
NRC Implementation	nc	nc	nc	nc	nc	nc	nc	nc	nc
NRC Operation	nc	nc	nc	nc	nc	nc	nc	nc	nc
<b>Total Costs</b>	<b>-\$16,399,000</b>	<b>-\$42,096,000</b>	<b>-\$46,861,000</b>	<b>-\$16,399,000</b>	<b>-\$42,096,000</b>	<b>-\$46,861,000</b>	<b>-\$16,399,000</b>	<b>-\$42,096,000</b>	<b>-\$46,861,000</b>
<b>Net Benefit</b>	<b>-\$12,465,000</b>	<b>-\$39,247,000</b>	<b>-\$44,884,000</b>	<b>-\$10,344,100</b>	<b>-\$37,709,900</b>	<b>-\$43,817,100</b>	<b>\$11,323,300</b>	<b>-\$22,038,500</b>	<b>-\$32,957,300</b>

1. nc = not calculated
2. Results are expressed in current dollars (year 2012 dollars) except for the undiscounted cases, which are expressed in constant dollars.

As shown in Table 107, calculated net benefits for requiring low-density spent fuel pool storage at the reference plant do not achieve a positive net benefit for eight of the nine cases presented. One case, the undiscounted high estimate, shows a positive net benefit of about \$11.3 million, which reflects the value and impacts at the time in which they are incurred with no present worth conversion. It is informative to compare this value to the other high estimate values of (\$22.0 million) and (\$33.0 million), which differ from this case by adjusting these future costs into year 2012 dollars using 3-percent and 7-percent discount rates as described in section D.3.2.1.2.

**D.4.1.4.3 Combined Effect of Consequences Extending Beyond 50 Miles and Dollar per Person-Rem Conversion Factor**

This sensitivity analysis considers all initiating events that can challenge the reference plant's spent fuel pool cooling or integrity while taking into account the combined effects of extending the analysis of consequences beyond 50 miles from the site and increasing the dollar per person-rem conversion value from \$2,000 to \$4,000 per person-rem averted. The combined effects of these two variables on the calculated net benefits are provided in Table 108.

**Table 108 Combined Sensitivity Analysis that Analyzes Consequences Beyond 50 Miles using a Revised Dollar per Person-Rem Conversion Factor on the Net Benefits for Low-density Spent Fuel Pool Storage for All Initiator Events**

Attribute	Best Estimate			Low Estimate			High Estimate		
	Undiscounted	3% NPV	7% NPV	Undiscounted	3% NPV	7% NPV	Undiscounted	3% NPV	7% NPV
Public Health (Accident)	\$3,566,900	\$2,583,800	\$1,793,400	\$2,162,500	\$1,566,500	\$1,087,300	\$31,471,600	\$22,798,200	\$15,823,400
Occupational Health (Accident)	\$2,500	\$1,900	\$1,400	\$1,300	\$1,000	\$700	\$42,700	\$30,900	\$21,400
Offsite Property	\$2,139,300	\$1,549,700	\$1,075,600	\$4,968,300	\$3,599,100	\$2,498,000	\$11,586,600	\$8,393,400	\$5,825,500
Onsite Property	\$10,400	\$6,900	\$4,300	\$4,680	\$3,150	\$2,030	\$378,600	\$249,600	\$155,800
<b>Total Benefits</b>	<b>\$5,719,100</b>	<b>\$4,142,300</b>	<b>\$2,874,700</b>	<b>\$7,136,800</b>	<b>\$5,169,800</b>	<b>\$3,588,000</b>	<b>\$43,479,500</b>	<b>\$31,472,100</b>	<b>\$21,826,100</b>
Occupational Health (Routine)	-\$18,000	-\$49,000	-\$54,000	-\$18,000	-\$49,000	-\$54,000	-\$18,000	-\$49,000	-\$54,000
Industry Implementation	-\$15,660,000	-\$41,820,000	-\$46,770,000	-\$15,660,000	-\$41,820,000	-\$46,770,000	-\$15,660,000	-\$41,820,000	-\$46,770,000
Industry Operation	-\$730,000	-\$252,000	-\$64,000	-\$730,000	-\$252,000	-\$64,000	-\$730,000	-\$252,000	-\$64,000
NRC Implementation	nc	nc	nc	nc	nc	nc	nc	nc	nc
NRC Operation	nc	nc	nc	nc	nc	nc	nc	nc	nc
<b>Total Costs</b>	<b>-\$16,408,000</b>	<b>-\$42,121,000</b>	<b>-\$46,888,000</b>	<b>-\$16,408,000</b>	<b>-\$42,121,000</b>	<b>-\$46,888,000</b>	<b>-\$16,408,000</b>	<b>-\$42,121,000</b>	<b>-\$46,888,000</b>
<b>Net Benefit</b>	<b>-\$10,689,000</b>	<b>-\$37,979,000</b>	<b>-\$44,013,000</b>	<b>-\$9,271,200</b>	<b>-\$36,951,200</b>	<b>-\$43,300,000</b>	<b>\$27,071,500</b>	<b>-\$10,648,900</b>	<b>-\$25,061,900</b>

1. nc = not calculated
2. Results are expressed in current dollars (year 2012 dollars) except for the undiscounted cases, which are expressed in constant dollars.

As shown in Table 108, calculated net benefits for requiring low-density spent fuel pool storage at the reference plant do not achieve a positive net benefit for eight of the nine cases presented. One case, the undiscounted high estimate, shows a positive net benefit of about \$27.1 million, which reflects the value and impacts at the time in which they are incurred with no present worth conversion. It is informative to compare this value to the other high estimate values of (\$10.6 million) and (\$25.1 million), which differ from this case by adjusting these future costs into year 2012 dollars using 3-percent and 7-percent discount rates as described in section D.3.2.1.2.

#### **D.4.2 Backfit Analysis**

As discussed above, the NRC has determined that the reference plant would not achieve a substantial increase in the protection of public health and safety from a change to low-density spent-fuel-pool storage. The NRC has therefore determined that imposing a requirement to use only low-density spent fuel pool storage at the reference plant would not meet the requirements of the backfit rule. However, to ensure that there is a complete discussion of these issues, the NRC has drafted an analysis of the costs associated with imposing these requirements as a backfit for illustrative purposes. This analysis of the direct and indirect costs of implementing the new requirements provides an assessment of the costs associated with imposing these requirements and the relative safety benefits in terms of the NRC's backfit rule. This backfit analysis examines the impacts of requiring low-density spent fuel pool storage at the reference plant relative to the baseline used in the regulatory analysis, which consists of existing requirements including the recently issued orders.

This plant-specific backfit analysis differs from most NRC's backfit analyses in that the NRC is not imposing or proposing to impose any requirements on its licensees. Instead, the NRC is assessing the safety benefits and costs of hypothetical requirements that, if implemented, would result in the use of low-density spent fuel pool storage and a corresponding increase in on-site dry cask storage for the reference plant. An NRC rulemaking to impose requirements like the ones analyzed in this appendix would need to include a backfit analysis. This section of the appendix provides a discussion of some of the elements that would be analyzed as part of a backfit analysis of these requirements. Prior to imposing these requirements through a rulemaking the NRC would, at the very least, issue a separate regulatory bases for public comment. If it is determined that rulemaking is required, the NRC would issue a proposed rule for public comment.

#### **Low-density Spent Fuel Pool Storage Alternative Requirements that Constitutes a Plant-Specific Backfit for the Reference Plant**

- All spent fuel assemblies that have cooled for at least five years (older spent fuel assemblies) after discharge from the reactor core are expeditiously moved from spent fuel pool storage from spent fuel pool storage to dry cask storage.
- The completion of the initial movement of older spent fuel assemblies to dry cask storage is achieved within five years of the effective date of the requirement.
- Following each refueling outage, the older spent fuel assemblies stored in the pool shall be moved to dry cask storage in a timely manner.

In performing this analysis, the NRC considered the nine factors in 10 CFR 50.109, as described in the following subsections.



#### D.4.2.1 General Description of the Activity Required at the Reference Plant to Complete the Backfit

The alternative would require that the licensee of the reference plant incur upfront costs, including engineering, design, and licensing costs; equipment costs; construction costs; and start up and testing costs, as necessary for their independent spent fuel storage installation to accept the dry storage cask systems. The licensee would also need to purchase and load dry storage casks on a periodic basis in compliance with the regulatory requirement.

#### D.4.2.2 Potential Change in the Risk to the Public from the Accidental Offsite Release of Radioactive Material

**Table 109 Public Health (Accident) Person-Rem Averted**

Case	Dose (averted person-rem)			Benefits (2012 dollars)						
	Low Est.	Best Est.	High Est.	Undiscounted	3% Net Present Value			7% Net Present Value		
				Best Est.	Low Est.	Best Est.	High Est.	Low Est.	Best Est.	High Est.
Low-density storage	60	124	1,260	\$247,700	\$86,700	\$179,500	\$1,825,500	\$60,200	\$124,600	\$1,267,000

Results are expressed in current dollars (year 2012 dollars) except for the undiscounted cases, which are expressed in constant dollars.

If the NRC were to implement the low-density storage proposal, the storage of spent fuel in dry storage casks would decrease the accidental offsite release of radioactive material from a postulated spent fuel pool accident. As Table 109 shows, dry cask storage at the reference plant would decrease the radiation exposure to the public by between 60 and 1,260 person-rem. The dose to the public mostly comes from the reoccupation of land after decontamination and the exposure to the workers who are decontaminating the public land. This analysis also assumes that 0.5% of the public will not evacuate during the accident. This resultant radiation dose is included within the public health exposure. As shown in the regulatory analysis, the best estimate benefits range from \$0.18 million (3 percent net present value) to \$0.12 million (7 percent net present value). A more in-depth review of the person-rem exposure to the public is found in section D.3.4.2.

#### D.4.2.3 Potential Impact on Radiological Exposure of Facility Employees

**Table 110 Facility Employee Exposure**

Case	Dose (averted person-rem)			Benefits (2012 dollars)						
	Low Est.	Best Est.	High Est.	Undiscounted	3% Net Present Value			7% Net Present Value		
				Best Est.	Low Est.	Best Est.	High Est.	Low Est.	Best Est.	High Est.
accident short-term	0.268	0.421	5.493	\$841	\$388	\$628	\$7,959	\$269	\$453	\$5,524
accident long-term	0.068	0.208	5.170	\$415	\$98	\$310	\$7,490	\$68	\$223	\$5,198
routine	-4.560	-4.560	-4.560	-\$9,000	-\$24,000	-\$24,000	-\$24,000	-\$27,000	-\$27,000	-\$27,000
Total	-4.224	-3.932	6.103	-\$7,744	-\$23,514	-\$23,063	-\$8,552	-\$26,662	-\$26,324	-\$16,278

Results are expressed in current dollars (year 2012 dollars) except for the undiscounted cases, which are expressed in constant dollars.

If imposed on licensees, these requirements would provide added assurance that nuclear industry workers are not subjected to unnecessary radiological or hazardous chemical exposures as the result of mitigative and clean-up activities associated with a spent fuel pool accident that results in a radioactive release. Storage of spent fuel in dry storage casks would decrease the post-accidental offsite radiation exposure to facility employees from a postulated spent fuel pool accident. The exposure of facility employees comes from a short-term dose, based on the exposure during the accident, and a long-term dose, based on the exposure from

the onsite cleanup costs. Facility employees, however, receive additional radiation exposure during DSC loading and handling activities, ISFSI operations, and maintenance and surveillance activities, resulting in a net increase in radiation exposure as shown in Table 110 for the low and best estimates. A more in-depth discussion of the person-rem exposure to facility employees can be found in sections D.3.4.2 and D.3.4.3.

**D.4.2.4 Installation and Continuing Costs Associated with the Backfit, including the Cost of Facility Downtime or the Cost of Construction Delay**

**Table 111 Installation and Continuing Costs Associated with the Backfit**

Case	Costs (2012 dollars)		
	Undiscounted	3% NPV	7% NPV
Implementation costs	-\$15,660,000	-\$41,820,000	-\$46,770,000
Operation costs	-\$730,000	-\$252,000	-\$64,000
Total	-\$16,390,000	-\$42,072,000	-\$46,834,000

Implementation and continuing costs include the upfront costs, which include engineering, design, and licensing costs; equipment costs; construction costs; and start up and testing costs, as necessary, for the reference plant’s independent spent fuel storage installation to accept the dry storage cask systems. In addition, the licensee would need to purchase and load dry storage casks on a periodic basis in compliance with regulatory requirements. As these actions are assumed not to affect normal power operations, there are no assumed replacement energy costs or construction delays. A more detailed analysis of the industry implementation and operation costs is provided in sections D.3.4.6 and D.3.4.7.

**D.4.2.5 Potential Safety Impact of Changes in Plant or Operational Complexity, including the Relationship to Proposed and Existing Regulatory Requirements**

If imposed on licensees, these requirements are not expected to have a significant effect on facility complexity. The scheduling and performance of loading spent fuel assemblies from the spent fuel pool into casks and transporting them to the ISFSI would add additional complexity to plant operations, especially during the initial 5-year loading phase. The added plant operations complexity is not significant and will not substantially affect the reference plant operational practices or result in substantial indirect costs. However, should a cask drop accident occur during plant operation, even though its likelihood is remote, the event could challenge plant safety systems in mitigating the consequences.

**D.4.2.6 Estimated Resource Burden on the NRC Associated with the Proposed Backfit and the Availability of Such Resources.**

The establishment of the requirements needed to require the reference plant to move expeditiously all spent fuel assemblies that have cooled for at least five years (older spent fuel assemblies) after discharge from the reactor core from spent fuel pool storage to dry cask storage would require rulemaking. The rulemaking would not result in a substantial increase in annual expenditures of agency resources.

#### D.4.2.7 Potential Impact of Differences in Facility Type, Design, or Age on the Relevancy and Practicality of the Proposed Action

There is no expected significant differentiation in how individual plants would implement the requirement to expeditiously move all spent fuel assemblies that have cooled for at least five years (older spent fuel assemblies) after discharge from the reactor core from spent fuel pool storage to dry cask storage. If imposed on licensees, these requirements do not directly relate to the facility type, design, or age.

#### D.4.2.8 Whether the Proposed Backfit is Interim or Final and, if Interim, the Justification for Imposing the Proposed Backfit on an Interim Basis

This consideration is not relevant to the analysis at this time because no requirements are being proposed.

#### D.4.2.9 Other Information Relevant and Material to the Proposed Backfit

**Table 112 Summary of Backfitting Net Benefits for Low-density Spent Fuel Pool Storage for All Initiator Events (within 50 miles)**

Attribute	Best Estimate			Low Estimate			High Estimate		
	Undiscounted	3% NPV	7% NPV	Undiscounted	3% NPV	7% NPV	Undiscounted	3% NPV	7% NPV
Public Health (Accident)	\$247,700	\$179,500	\$124,600	\$119,700	\$86,700	\$60,200	\$2,520,000	\$1,825,500	\$1,267,000
Occupational Health (Accident)	\$1,300	\$900	\$700	\$700	\$500	\$300	\$21,300	\$15,400	\$10,700
Occupational Health (Routine)	-\$9,000	-\$24,000	-\$27,000	-\$9,000	-\$24,000	-\$27,000	-\$9,000	-\$24,000	-\$27,000
<b>Total Benefits</b>	<b>\$240,000</b>	<b>\$156,400</b>	<b>\$98,300</b>	<b>\$111,400</b>	<b>\$63,200</b>	<b>\$33,500</b>	<b>\$2,532,300</b>	<b>\$1,816,900</b>	<b>\$1,250,700</b>
Industry Implementation	-\$15,660,000	-\$41,820,000	-\$46,770,000	-\$15,660,000	-\$41,820,000	-\$46,770,000	-\$15,660,000	-\$41,820,000	-\$46,770,000
Industry Operation	-\$730,000	-\$252,000	-\$64,000	-\$730,000	-\$252,000	-\$64,000	-\$730,000	-\$252,000	-\$64,000
NRC Implementation	nc	nc	nc	nc	nc	nc	nc	nc	nc
NRC Operation	nc	nc	nc	nc	nc	nc	nc	nc	nc
<b>Total Costs</b>	<b>-\$16,390,000</b>	<b>-\$42,072,000</b>	<b>-\$46,834,000</b>	<b>-\$16,390,000</b>	<b>-\$42,072,000</b>	<b>-\$46,834,000</b>	<b>-\$16,390,000</b>	<b>-\$42,072,000</b>	<b>-\$46,834,000</b>
<b>Net Benefit</b>	<b>-\$16,150,000</b>	<b>-\$41,916,000</b>	<b>-\$46,736,000</b>	<b>-\$16,279,000</b>	<b>-\$42,009,000</b>	<b>-\$46,801,000</b>	<b>-\$13,858,000</b>	<b>-\$40,255,000</b>	<b>-\$45,583,000</b>

1. nc = not calculated
2. Results are expressed in current dollars (year 2012 dollars) except for the undiscounted cases, which are expressed in constant dollars.

Table 112 summarizes the described benefits and costs associated with the proposed backfit to require the reference plant to expeditiously move all older spent fuel assemblies after discharge from the reactor core from spent fuel pool storage to dry cask storage. The analyzed alternative would also incur onsite and offsite property cost offsets from an accident. These cost offsets are summarized in Table 113

**Table 113 Summary of Cost Offsets for Onsite and Offsite Property**

Attribute	Total Cost Offsets								
	Best Estimate			Low Estimate			High Estimate		
	Undiscounted	3% NPV	7% NPV	Undiscounted	3% NPV	7% NPV	Undiscounted	3% NPV	7% NPV
Offsite Property	\$723,300	\$524,000	\$363,700	\$1,073,300	\$777,500	\$539,700	\$4,587,800	\$3,323,400	\$2,306,700
Onsite Property	\$10,400	\$6,900	\$4,300	\$4,480	\$2,950	\$1,830	\$378,600	\$249,600	\$155,800
<b>Total Benefits</b>	<b>\$733,700</b>	<b>\$530,900</b>	<b>\$368,000</b>	<b>\$1,077,800</b>	<b>\$780,500</b>	<b>\$541,500</b>	<b>\$4,966,400</b>	<b>\$3,573,000</b>	<b>\$2,462,500</b>

1. nc = not calculated
2. Results are expressed in current dollars (year 2012 dollars) except for the undiscounted cases, which are expressed in constant dollars.

**Table 114 Combined Sensitivity Analysis of the Backfitting Net Benefits for Low-density Spent Fuel Pool Storage for All Initiator Events (extending analysis beyond 50 miles and using a Revised Dollar per Person-Rem Conversion Factor)**

Attribute	Best Estimate			Low Estimate			High Estimate		
	Undiscounted	3% NPV	7% NPV	Undiscounted	3% NPV	7% NPV	Undiscounted	3% NPV	7% NPV
Public Health (Accident)	\$3,566,900	\$2,583,800	\$1,793,400	\$2,162,500	\$1,566,500	\$1,087,300	\$31,471,600	\$22,798,200	\$15,823,400
Occupational Health (Accident)	\$2,500	\$1,900	\$1,400	\$1,300	\$1,000	\$700	\$42,700	\$30,900	\$21,400
Occupational Health (Routine)	-\$18,000	-\$49,000	-\$54,000	-\$18,000	-\$49,000	-\$54,000	-\$18,000	-\$49,000	-\$54,000
<b>Total Benefits</b>	<b>\$3,551,400</b>	<b>\$2,536,700</b>	<b>\$1,740,800</b>	<b>\$2,145,800</b>	<b>\$1,518,500</b>	<b>\$1,034,000</b>	<b>\$31,496,300</b>	<b>\$22,780,100</b>	<b>\$15,790,800</b>
Industry Implementation	-\$15,660,000	-\$41,820,000	-\$46,770,000	-\$15,660,000	-\$41,820,000	-\$46,770,000	-\$15,660,000	-\$41,820,000	-\$46,770,000
Industry Operation	-\$730,000	-\$252,000	-\$64,000	-\$730,000	-\$252,000	-\$64,000	-\$730,000	-\$252,000	-\$64,000
NRC Implementation	nc	nc	nc	nc	nc	nc	nc	nc	nc
NRC Operation	nc	nc	nc	nc	nc	nc	nc	nc	nc
<b>Total Costs</b>	<b>-\$16,390,000</b>	<b>-\$42,072,000</b>	<b>-\$46,834,000</b>	<b>-\$16,390,000</b>	<b>-\$42,072,000</b>	<b>-\$46,834,000</b>	<b>-\$16,390,000</b>	<b>-\$42,072,000</b>	<b>-\$46,834,000</b>
<b>Net Benefit</b>	<b>-\$12,838,600</b>	<b>-\$39,535,300</b>	<b>-\$45,093,200</b>	<b>-\$14,244,200</b>	<b>-\$40,553,500</b>	<b>-\$45,800,000</b>	<b>\$15,106,300</b>	<b>-\$19,291,900</b>	<b>-\$31,043,200</b>

1. nc = not calculated
2. Results are expressed in current dollars (year 2012 dollars) except for the undiscounted cases, which are expressed in constant dollars.

Table 114 summarizes the results of the combined sensitivity analyses that extended the backfitting net benefit analysis beyond 50 miles from the plant site and used a higher per person-rem conversion factor to monetize averted dose. The analyzed alternative would also incur onsite and offsite property cost offsets from an accident. These cost offsets for the combined sensitivity analysis are summarized in Table 115.

**Table 115 Summary of Combined Sensitivity Analysis Cost Offsets for Onsite and Offsite Property**

Attribute	Total Cost Offsets								
	Best Estimate			Low Estimate			High Estimate		
	Undiscounted	3% NPV	7% NPV	Undiscounted	3% NPV	7% NPV	Undiscounted	3% NPV	7% NPV
Offsite Property	\$2,139,300	\$1,549,700	\$1,075,600	\$4,968,300	\$3,599,100	\$2,498,000	\$11,586,600	\$8,393,400	\$5,825,500
Onsite Property	\$10,400	\$6,900	\$4,300	\$4,680	\$3,150	\$2,030	\$378,600	\$249,600	\$155,800
<b>Total Benefits</b>	<b>\$2,149,700</b>	<b>\$1,556,600</b>	<b>\$1,079,900</b>	<b>\$4,973,000</b>	<b>\$3,602,300</b>	<b>\$2,500,000</b>	<b>\$11,965,200</b>	<b>\$8,643,000</b>	<b>\$5,981,300</b>

1. nc = not calculated
2. Results are expressed in current dollars (year 2012 dollars) except for the undiscounted cases, which are expressed in constant dollars.

#### D.4.3 Disaggregation

In order to comply with the guidance provided in Section 4.3.2 (“Criteria for the Treatment of Individual Requirements”) of the Regulatory Analysis Guidelines, the NRC conducted a screening review to ensure that the aggregate analysis does not mask the inclusion of individual provisions that are not cost-beneficial when considered individually and not necessary to meet the goals of imposing these requirements on the reference plant. Consistent with the Regulatory Guidelines, the NRC evaluated, on a disaggregated basis, each new regulatory provision expected to result in incremental costs. Based on this screening review, the NRC did not identify any requirements needing further consideration. The NRC believes that each of these provisions described in section D.4.2 is necessary in the aggregate for the expedited transfer of spent fuel to DSCs. However, as noted above, the Commission has not found that accelerated transfer to DSCs to provide a substantial safety benefit, nor to be cost justified.

#### D.4.4 Safety Goal Evaluation

Safety goal evaluations are applicable only to regulatory initiatives considered to be generic safety enhancement backfits subject to the substantial additional protection standard in 10 CFR 50.109(a)(3).

The frequency of damage to the spent fuel is estimated to be range from  $7.11 \times 10^{-7}$  to  $5.39 \times 10^{-6}$  per reactor-year when considering all initiators that could challenge spent fuel pool cooling or integrity. These values, when compared to a target value of  $1 \times 10^{-4}$ , which is the quantitative health objective for latent cancer fatalities derived using reactor accident characterizations, represents a 0.71% to 5.39% of the overall frequency of core damage.

The frequency of a release of radioactive material to the environment is assumed to be the same as the frequency of spent fuel damage. The reactor building, which houses the spent fuel pool, does not provide a containment barrier similar to the containment structure surrounding the reactor core, especially under the conditions postulated to dominate the release of radioactive materials from spent fuel.

It is difficult to compare the estimated  $7.11 \times 10^{-7}$  to  $5.39 \times 10^{-6}$  per reactor-year release frequencies for the postulated spent fuel pool accident when considering all initiators to a target value of  $1 \times 10^{-5}$  per reactor year for a large early release frequency (LERF). The spent fuel pool source term is not similar to the core damage (or melt) source term for which the consequences of a spent fuel pool accident are predicted to have no early fatalities and public health risk is dominated by latent cancer risks resulting from long-term exposures. Because the analyzed spent fuel accident is a slow progression with at least eight hours before an environmental release occurs, and the resultant release is not expected to result in any offsite early fatalities, the analysis suggests that the spent fuel pool release does not fall within the definition of a large early release. Although this analyzed accident is different from a reactor accident, the spent fuel pool estimated release frequencies of  $7.11 \times 10^{-7}$  to  $5.39 \times 10^{-6}$  per reactor-year meets the  $1 \times 10^{-5}$  LERF guidelines.

Societal risk is based on the statistically expected number of early and latent cancer fatalities. The Safety Goals for the Operation of Nuclear Power Plants: Policy Statement (51 FR 28044) defines the early fatality area calculation as that within one mile from the site boundary. As discussed above, the resultant release is not expected to result in any offsite early fatalities. A ten-mile radius is defined for calculating latent cancer fatalities. The second quantitative objective of the Policy Statement is for the risk to the population in the vicinity of a nuclear power plant from an accident at a nuclear power plant should not exceed 0.1 percent of the sum of cancer fatality risks resulting from all other causes. Based on recent data (<http://www.cancer.org/research/cancerfactsfigures/index>) the total fatality rate from cancer in the U.S. is 580,350 per 315,747,500 persons (<http://www.census.gov/popclock/>) or a risk of  $1.84 \times 10^{-3}$  per year, which results in a safety goal of  $1.84 \times 10^{-6}$  per year. Using the bounding frequency of damage to the spent fuel of  $5.39 \times 10^{-6}$  per reactor-year, which considers all initiators that could challenge spent fuel pool cooling or integrity, and the conditional individual latent cancer fatality risk within a ten-mile radius is  $4.4 \times 10^{-4}$  yields a bounding latent cancer fatality risk of  $2.37 \times 10^{-9}$  of cancer fatality per year. This calculated value of  $2.37 \times 10^{-9}$  latent cancer fatalities per reactor-year associated with a spent fuel pool accident is less than represents a 0.13% fraction of the  $1.84 \times 10^{-6}$  per year societal risk goal value based on the calculation area specified in the Safety Goal Policy Statement.

Therefore, the risk of a spent fuel pool accident at the reference plant appears to meet the Safety Goal Policy Statement public health objectives. They also meet the  $1 \times 10^{-5}$  per reactor-year LERF guideline. Therefore, the Regulatory Baseline is justified for the alternative described in section D.2.2 as evaluated for the reference plant.

#### **D.4.5 CRGR Results**

This section addresses regulatory analysis information requirements for rulemaking actions or staff positions subject to review by the Committee to Review Generic Requirements (CRGR). All information called for by the CRGR is presented in this regulatory analysis.

### **D.5 DECISION RATIONALE**

This section presents the decision rationale, including the basis for selection, any decision criteria used, the regulatory instrument to be used (if applicable), and the statutory basis for the selected regulatory action. The decision rationale is presented in two different ways, in order to address the differing decision criteria between regulatory analyses and backfit analyses (10 CFR 50.109).

#### **D.5.1 Regulatory Analysis**

Table 103 shows that a requirement for low-density spent fuel storage alternative does not achieve a cost-beneficial increase in public health and safety for the reference plant using the current regulatory framework when all event initiators, which may challenge spent fuel cooling or pool integrity, are considered. Furthermore, the three sensitivity studies provided in section D.4.1.4 also showed that the low-density spent fuel storage alternative was not cost-justified for any of the discounted sensitivity cases.

The NRC believes that there are other considerations discussed in section D.3.4.10 that would further reduce the quantified benefits and make the proposed alternative less justifiable. Based on the NRC's assessment of the costs and benefits, the agency has concluded that the risk due to beyond design basis accidents in spent fuel pools, while not negligible, is sufficiently low that the added costs involved with expediting the movement of spent fuel from the pool to achieve the low-density fuel pool storage alternative evaluated for the reference plant is not warranted.

#### **D.5.2 Backfit Analysis**

The NRC conducted a backfit analysis for the reference plant relative to the backfit requirements in 10 CFR 50.109 for illustrative purposes. The NRC does not believe that this alternative results in a cost-justified substantial safety enhancement for the reference plant. First, the risk of a spent fuel pool accident at the reference plant appears to meet the Safety Goal Policy Statement public health objectives. The estimated spent fuel pool accident release frequency is also less than the  $1 \times 10^{-5}$  per reactor-year LERF guideline. Second, the cost-justified criteria are not met when evaluating the averted accident consequences within 50 miles of the site consistent with the regulatory framework. Sensitivity analyses that extend the analyses beyond 50 miles also show that the low-density spent fuel storage alternative was not cost-justified for any of the discounted sensitivity cases. Therefore, the Regulatory Baseline is justified for the alternative described in section D.2.2 as evaluated for the reference plant.

In light of the findings above, the NRC concludes that the quantified safety benefits of the proposed requirements that qualify as backfits, considered in the aggregate, would not

constitute a substantial increase in protection to public health or safety or the common defense and security, and the costs of these requirements would not be justified in view of the increase in protection to safety and security provided by the backfits embodied in these requirements on the reference plant.

### **D.5.3 Conclusion**

The regulatory screening analysis and the backfitting discussion in this appendix indicate that for the reference plant a requirement for low-density spent fuel pool storage, and an associated requirement for expedited transfer of spent fuel from the spent fuel pool to meet a low-density spent fuel pool storage requirement, are not justified.

The risk due to beyond design basis accidents in the spent fuel pool analyzed in this study, is sufficiently low that the added costs involved with expediting the movement of spent fuel from the pool to achieve the low-density fuel pool storage alternative are not warranted. While the expedited fuel movement alternative evaluated is not cost-beneficial, the report has discovered that an alternative 1x8 high-density fuel configuration may have significantly lower costs in implementation and potentially similar benefits to the low-density configuration. This alternative should be evaluated further, in addition to other possible spent fuel pool loading configurations, as part of the regulatory analysis for expedited fuel movement described in SECY-12-0095 to evaluate the transfer of spent fuel to dry cask storage for existing and new (future) nuclear power plants.

## **D.6 REFERENCES**

Consequence Study of a Beyond-Design-Basis Earthquake Affecting the Spent Fuel Pool at a Selected US Mark I Boiling Water Reactor (Spent Fuel Pool Study), Interim Report (Draft), dated June 2012 (ADAMS Accession No. ML12159A180).

Devcan Version 6.6.1, National Cancer Institute (<http://surveillance.cancer.gov/devcan/>).  
Source: NCHS public use data file for the total U.S., April 2012.

EPRI TR-1018058, "Occupational Risk Consequences of the Department of Energy's Approach to Repository Design, Performance Assessment and Operation in the Yucca Mountain License Application," dated August 2008.

EPRI TR-1018722, "Cost Estimate for an Away-From-Reactor Generic Interim Storage Facility (GISF) for Spent Nuclear Fuel," dated May 2009.

EPRI TR-1021048, "Industry Spent Fuel Storage Handbook," dated July 2010.

EPRI TR-1021049, "Impacts Associated with Transfer of Spent Nuclear Fuel from Spent Fuel Storage Pools to Dry Storage after Five Years of Cooling," dated 2010.

EPRI TR-1025206, "Impacts Associated with Transfer of Spent Nuclear Fuel from Spent Fuel Storage Pools to Dry Storage after Five Years of Cooling, Revision 1, dated August 2012.

INPO 11-005, "Special Report on the Nuclear Accident at the Fukushima Daiichi Nuclear Power Station, Rev. 0, November 2011.

International Commission on Radiological Protection (ICRP), "1990 Recommendations of the International Commission on Radiological Protection," Publication 60, *Ann. ICRP* 21 (1-3), 1991.

\_\_\_\_\_. 2008. "The 2007 Recommendations of the International Commission on Radiological Protection," Publication 103. *Ann. ICRP* 37 (2-4), 2008.

Jones-Lee, M.W., "Valuing International Safety Externalities: Does the 'Golden Rule' Apply?" *Journal of Risk and Uncertainty*, 29.3:277-287, 2004.

Kiyoshi, Kurokawa, et al. Japan. The National Diet of Japan. "Fukushima Nuclear Accident Independent Investigation Commission," The National Diet of Japan, 2012.

Office of Management of the Budget Circular A-4, "Regulatory Analysis," issued September 2003.

Order EA-12-049, "Order Modifying Licenses with Regard to Requirements for Mitigation Strategies for Beyond-Design-Basis External Events," dated March 12, 2012.

Order EA-12-051, "Order Modifying Licenses with Regard to Reliable Spent Fuel Pool Instrumentation," dated March 12, 2012.



Prassinis, P.G. et al. "Seismic Failure and Cask Drop Analyses of the Spent Fuel Pools at Two Representative Nuclear Power Plants," NUREG/CR-5176, January 1989.

PRM-51-10, "Proposed Amendment to 10 CFR Part 51," dated August 25, 2006.

PRM-51-12, "Proposed Amendment to 10 CFR Part 51 (Rescinding finding that environmental impacts of pool storage of spent nuclear fuel are insignificant), dated March 16, 2007.

SECY-12-0095, "Tier 3 Program Plans and 6-Month Status Update in Response to Lessons Learned from Japan's March 11, 2011, Great Tohoku Earthquake and Subsequent Tsunami," dated July 13, 2012 (ADAMS Accession No. ML12165A089).

SRM-SECY-93-086, "Backfit Considerations," dated June 30, 1993 (ADAMS Accession No. ML003760758).

SRM-SECY-12-0025, "Proposed Orders and Requests for Information in Response to Lessons Learned from Japan's March 11, 2011, Great Tohoku Earthquake and Tsunami," dated March 9, 2012 (ADAMS Accession No. ML120690347).

U.S. Nuclear Regulatory Commission (NRC), 2001. "Recommendations for Enhancing Reactor Safety in the 21st Century."

\_\_\_\_\_. 1999. "Spent Fuel Heat Generation in an Independent Spent Fuel Storage Installation," Regulatory Guide 3.54, Rev. 1.

\_\_\_\_\_. 2004. "Regulatory Analysis Guidelines of the U.S. Nuclear Regulatory Commission," NUREG/BR-0058, Revision 4.

\_\_\_\_\_. 1997. "Regulatory Analysis Technical Evaluation Handbook," NUREG/BR-0184.

\_\_\_\_\_. 1989. "Value/Impact Analyses of Accident Preventive and Mitigative Options for Spent Fuel Pools," NUREG/CR-5281 (ADAMS Accession No. ML071690022).

\_\_\_\_\_. 2005. "Identification and Analysis of Factors Affecting Emergency Evacuations," NUREG/CR-6864.

\_\_\_\_\_. 1989. "Regulatory Analysis for the Resolution of Generic Issue 82, Beyond Design Basis Accidents in Spent Fuel Pools," NUREG-1353.

\_\_\_\_\_. 1990. "Backfitting Guidelines," NUREG-1409.

\_\_\_\_\_. "Generic Environmental Impact Statement for License Renewal of Nuclear Plants," Draft Report for Comment, NUREG-1437.

\_\_\_\_\_. 1995. "Reassessment of NRC's Dollar Per Person-Rem Conversion Factor Policy," NUREG-1530.

\_\_\_\_\_. 2001. "Technical Study of Spent Fuel Pool Accident Risk at Decommissioning Nuclear Power Plants," NUREG-1738.

\_\_\_\_\_. 1992. "NRC Labor Rates in the Generic Cost Catalog," NUREG/CR-4627, Rev. 2.

Wada, Koji, Toru Yoshikawa, Takeshi Hayashi, and Yoshiharu Aizawa, "Emergency Response Technical Work at Fukushima Dai-ichi Nuclear Power Plant: Occupational Health Challenges Posed by the Nuclear Disaster," *Occupational and Environmental Medicine* 2012; 69:599-602, April 12, 2012.

## APPENDIX E: SFPS PUBLIC COMMENTS SUMMARY

The Consequence Study of a Beyond-Design-Basis Earthquake Affecting the Spent Fuel Pool for a U.S. Mark I Boiling Water Reactor (SFPS) draft report was publicized in a press release on June 24, 2013, with a public comment period from July 2, 2013 through August 1, 2013. Comments related to the SFPS project covered a wide range of topics. This Appendix provides excerpts of the comments received along with NRC responses. All comments are located in the NRC's Agencywide Documents Access and Management System (ADAMS) with the below referenced accession numbers.

The comments below are organized by public commenter.

From: Marv Lewis (ADAMS Accession No. ML13196A302, ML13207A141, and ML13211A177):

1) **Comment:**

"The entire report seems to skirt the issue whether putting spent fuel pools on the roof of a reactor is logical or a design error"

**NRC Response:**

The elevated pool design used with the boiling water reactor (BWR) Mark I and II containment designs provides for the safe transfer of fuel from the reactor and the safe storage of fuel. The pool location allows for underwater transfer of fuel from the reactor vessel with substantial shielding provided by more than 10 feet of water above the fuel during transfer. The storage configuration maintains in excess of 20 feet of water above the stored fuel to provide for cooling of the fuel, protection from credible high-energy missiles that may fall into the pool, and mitigation of any radiological release that may result from a design-basis fuel handling accident. Systems attached to the pool provide for adequate cooling and have design features to prevent a substantial loss of coolant inventory under accident conditions, such as design-basis earthquakes and pipe breaks. The pool itself makes up a small part of the reactor building and, in addition to being constructed from very thick reinforced concrete walls with a leak-tight stainless steel liner, is surrounded by the reactor building structure, which consists of thick reinforced concrete walls at the level of the spent fuel pool and below. The heavy structural members that support the enclosure above the refueling floor have been designed to withstand extreme natural phenomena, but, for the several facilities in this class that have relatively lightweight sheathing, the sheathing has been designed to separate from the enclosure to prevent over-loading the structure. Thus, the spent fuel pools have been designed to provide for safe storage and transfer of the fuel used in these BWRs.

2) **Comment:**

“Water supply is evaluated only in the proximity of the fuel pool”

**NRC Response:**

The study assesses situations where deployment of mitigation is successful, and where mitigation is not successful, considering only portable pumping equipment because the study assumes that the normal ac-powered systems will be unavailable. The cases in Chapter 6 with unsuccessful deployment of mitigation subsume instances where the water source (which as the comment indicates is not proximate to the refuel floor) is unavailable because of either an event-driven failure or random failure.

3) **Comment:**

I applaud the use of color and simple way that seismology is explained. The tables and figures are easily read and understood. The problem emerges in that the graphs and explanation may be an oversimplification. I do not see many 2 sigma and 6 sigma confidence levels on the graphs and figures. If there is any confidence in the figures, data and graphs, the confidence levels should be clearly marked. Is the reader to assume the data is unassailable or to assume there is no confidence in the data?”

**NRC Response:**

The USGS 2008 model does not provide the various confidence levels, thus the report doesn't include this information. However, the point estimates provided by this model and used in the study account for confidence levels by providing for each peak ground acceleration average hazard estimates which are associated with confidence levels above the 50th percentile confidence level of the median point estimates. As compared to the median estimates, the confidence level percentiles for the average hazard curves increase when the uncertainties increase. As shown in Figure 2 (Chapter 3) of the report, the hazard curve used in the study predicts average seismic hazards greater than the average hazard curves used in previous NRC studies for peak ground accelerations greater than about 0.4g.

4) **Comment:**

“I respectfully suggest an extension of the comment period”

**NRC Response:**

Because this is a research study we did not extend the comment period. This research study does not authorize any licensee action or set regulatory requirements. This study also does not establish any Commission policy. The comment period was appropriate for a research study and provided sufficient opportunity to receive comments.

5) **Comment:**

“Are there any configurations and accidents that can ignite zirconium if the surface, alloying or other parameters are outside of the design due to error?”

**NRC Response:**

Nuclear fuel is fabricated with a high degree of quality assurance, with very tight design tolerances. The only credible scenario under which a zirconium fire is expected to occur in the spent fuel pool (SFP) is during accidents that lead to loss of water. This is investigated in this report. The air oxidation kinetics models in MELCOR for Zr-based alloys (including Zirlo and M5) are based on the research sponsored by NRC and documented in NUREG/CR-6846.

From: Robert Vandebosh (ADAMS Accession No. ML13190A353):

6) **Comment:**

“Study terminated after 3 days. One learns from Fukushima that adequate offsite emergency response cannot be guaranteed within 3 days”

**NRC Response:**

The assumptions regarding offsite support in this study are similar to those used in the State-of-the-Art Reactor Consequence Analyses (NUREG-1935). In NUREG-1935, the staff reviewed available resources and emergency plans for Peach Bottom (same reference plant as for this spent fuel study) and determined that adequate mitigation measures could be brought onsite within 24 hours, and be connected and functioning within 48 hours.

The 3 day truncation time was chosen to perform a detailed assessment of the accident progression and to capture the release characteristics. In all unmitigated cases studied in the report for which a zirconium fire is predicted to occur, fuel uncover occurs before 48 hours (see page 81) and radiological releases occur before 72 hours.

In the event of a prolonged severe accident, radiation and other hazards could make termination of an ongoing SFP release challenging. The staff included a sensitivity case reported in Section 9.8 to investigate releases that continue beyond 72 hours.

7) **Comment:**

“Too much credit is given to mitigation. It is difficult to predict all scenarios that could compromise mitigation.”

**NRC Response:**

The study analyzed scenarios with and without successful deployment of mitigation which reasonably characterizes the range of possibilities.

8) **Comment:**

“Inclusion in tables of cancer results assuming the existence of threshold doses goes against recommendations of radiation health professional organizations that LNT should be used.”

**NRC Response:**

Radiation health professional organizations differ in their assessment of how the consequences from low dose radiation should be reported. The SFPS uses the Linear No Threshold (LNT) model as the base for the reporting of results. The dose truncation methodology, introduced in the SOARCA analyses documented in NUREG-1935, is a sensitivity analysis. Because the health effects of low dose radiation are uncertain, this approach yields insights into how results might change if low dose radiation were less effective at cancer induction than predicted by the LNT model.

9) **Comment:**

“You give an example of a translation of a specific ground movement (0.12) into an earthquake magnitude. A similar example for your 0.7 g ground motion would be helpful.”

**NRC Response:**

The ground motion at a site is a function of both the magnitude of the earthquake and the distance from the source to the specific site as well as other factors such as source characteristics, how the regional geology transmits the seismic energy and how local geologic effects affect the ground motions. Calculation of the probability of exceeding a given peak ground acceleration at the site, accounts for the ground motions that may result from all potential seismic sources in the region around the site. Therefore, the calculated probability is an aggregate of the contribution of earthquakes with different magnitudes and distances to the site. Although a peak ground acceleration at the site is not generally associated with a single magnitude earthquake, probabilistic seismic hazard models provide an indication of the magnitude and range of the earthquakes that would contribute the most to the hazard at a given site. Section 3.3, first paragraph of page 37, of the report provides the magnitude and distance of the earthquakes expected to contribute the most to the 0.7g event by describing them as earthquakes with magnitude less than about 6.0 at distances of less than about 20 km.

From: Union of Concerned Scientists (ADAMS Accession No. ML13210A139):

10) **Comment:**

“In several tables and figures (e.g., Table 37, Figs. 96 and 97) you use the term "population-weighted" for Individual Latent Cancer Fatality Risk. I don't understand what this means for an individual. A search on the term "population-weighted" reveals it is never defined or explained in the text of the Report.”

**NRC Response:**

“Population-weighted, individual LCF risk” is the total amount of latent cancer fatalities predicted in a specified area, divided by the population that resides within that area. This definition has been added to Table 33 of the report.

**11) Comment:**

“Most of your High Density results are for a (1 x 4) configuration. But not all reactor pools are loaded in this configuration, and the length of time that regulations allow for achieving this density is said to be a secret (p. 208). Thus you are emphasizing a risk less than that actually associated with some pools.”

**NRC Response:**

The calculations in the report were for a specific reference SFP that implements a pre-arranged fuel loading pattern (see Table 15 and Section 9.3). Even though the specific time requirement for achieving the 1x4 arrangement is not publicly available information, the sensitivity calculations presented in Section 9.3 show that somewhat higher releases are expected in OCP1 and OCP2 for a contiguous fuel pattern, and the large releases for 1x4 in OCP3 are comparable to OCP2 (with contiguous fuel loading). The objective of this study was not to provide releases for all pools, but to specify a detailed accident progression analysis for a specific reference pool with additional sensitivity calculations to provide insights on releases from different loading patterns. In fact, Peach Bottom uses a 1x8 loading pattern, where most plants employ a 1x4 loading pattern.

**12) Comment:**

“The relative risk of these two storage options was the real need being served by the study, but the study utterly fails that goal”

“That was the central question that needed to be answered by the NRC’s study – what is the relative risk from the two onsite spent fuel storage options. That question remains shamefully unanswered in the study.”

“...relative risks and identified strategies and tactics that enhanced the risk reductions achievable... But this draft study fails to provide that very useful service.”

“This study could have, and should have, provided useful insights to the relative risk of spent fuel pool versus dry storage. The final report must remedy this fundamental flaw”

**NRC Response:**

Both storage options are safe and pose low risk to the public. The objective of this study was to compare the consequences of a beyond design basis earthquake on a representative spent fuel pool in two configurations, low and high density. The study concluded that both high and low density spent fuel configurations are safe, and that expedited transfer of spent fuel from the spent fuel pool to dry cask storage is not warranted for the SFP studied. Thus, the NRC staff does not agree with the statement that this study is fundamentally flawed.

**13) Comment:**

“In March 2012, the NRC ordered plant owners (of all plants, not just Peach Bottom Unit 3) to install instrumentation to monitor conditions inside the spent fuel pools at their facilities (see <http://pbadupws.nrc.gov/docs/ML1205/ML12056A044.pdf>). At the same time, the NRC also ordered plants owners to develop mitigation strategies to provide assurance of adequate cooling of reactor cores and spent fuel pools when permanent electrical supplies are unavailable for indefinite periods (see <http://pbadupws.nrc.gov/docs/ML1205/ML12054A735.pdf>). The NRC has applied a double standard”

“If the extreme earthquake scenario examined for a single reactor in the NRC’s study is sufficiently thorough and bounding, what was the basis for the NRC’s March 2012 orders that owners install spent fuel pool instrumentation and provide spent fuel pool cooling capabilities during extended power outages of infinite duration?”

“This NRC study wants us to believe that damage inflicted by an extreme earthquake on a highdensity loaded spent fuel pool poses little threat to public health and safety, even if it is not successfully mitigated within 3 days”

“The NRC’s March 2012 orders and its June 2013 draft study cannot both be right”

**NRC Response:**

Based on this study and previous studies, NRC believes that spent fuel pools protect public health and safety. Orders EA-12-051 and EA-12-049 currently being implemented by all operating U.S. nuclear power plants should serve to further reduce spent fuel pool accident risk by increasing the capability of nuclear power plant operators to monitor spent fuel pool water inventory and mitigate beyond-design-basis external events.

**14) Comment:**

“The study’s assumption that the battle is won or lost within 72 hours contradicts the mission time for other scenarios and the experience at Fukushima”

**NRC Response:**

Please see NRC response to Comment #6



**15) Comment:**

“The 30-day mission time is not applied across the board to every structure, system, and component in every scenario. When shorter mission times are applied, they are accompanied by solid justifications. The NRC study’s 3-day mission time is an unverified assumption.”

“The study’s imposition of the 3-day mission time serves to dismiss other plausible scenarios that could cause damage to irradiated fuel in spent fuel pools after 3 days. The study must consider longer mission times, and other scenarios that longer mission times permit. Proper consideration of longer mission times and other scenarios might show the risk is low – but that and that alone would be the proper method for dismissing these scenarios. Dismissing them via an arbitrary, unjustified assumption is poor science.”

“Other credible scenarios were summarily dismissed from consideration because they took longer than 3 days to play out”

**NRC Response:**

The NRC does not agree that the 3-day assumption is arbitrary or unjustified. In this regard, please see the response to Comment #6.

**16) Comment:**

“The extreme earthquake considered in the draft study may represent the fastest way to place the public in harm’s way from a spent fuel pool hazard. But to fixate on it and exclude other scenarios seems to replicate the tunnel-vision that factored into the March 1979 meltdown at Three Mile Island Unit 2.”

**NRC Response:**

The study is focused on a large seismic event (beyond the design-basis for the plant) because past studies (i.e., NUREG-1353 and NUREG-1738) have suggested that this is the largest contributor to SFP risk. In addition, in Appendix D (regulatory analysis), the staff also used calculated results from previous spent fuel pool studies to extend the applicability of this evaluation to include other initiators, which could challenge spent fuel pool cooling or integrity.

**17) Comment:**

“At a time when Americans cannot board a commercial airliner with more than 3 ounces of shampoo in a single container and without first removing footwear and all outwear to thwart terrorism, this study seems woefully deficient in summarily dismissing any and all acts of malice.”

**NRC Response:**

This study is a safety study of a severe earthquake impact on a reference SFP. Separate security studies were performed after 9/11 and are non-public. The sensitive unclassified

and classified analyses were made available to the Advisory Committee on Reactor Safeguards, the Government Accountability Office, and the National Academy of Sciences.

**18) Comment:**

“But what if a spent fuel pool only partially drains? In that case, the temperature rise is not checked (as shown in Figure 53) or turned around (as shown in Figure 55). Thus, a partially drained spent fuel pool represents a greater hazard than a fully drained one. Again, the NRC draft study opted for the better of these two choices to consider.”

“Yet there are other failure modes that may be caused by these lower accelerations, and these scenarios should be considered”

“Because a refueling cavity seal has failed in the past due to reasons other than forces resulting from an earthquake’s ground motion, it is unjustified to merely assume such failure cannot possibly be caused by a seismic event.”

“The study needs to examine the risk from draindown events, such as the one that happened at Haddam Neck, initiated by seismic events of less severity than that likely 1 in 60,000 year before dismissing such scenarios in favor of but one “bounding” case”

**NRC Response:**

The study did not analyze a partial draindown, which would correspond to a leak on the walls of the SFP, because the staff’s structural analysis for the reference pool studied showed that the walls are not potential leak locations. As discussed in Section 4 of the report the structural analysis predicted the earthquake would cause relative motion between the pool walls and the pool floor that would have the potential to result in cracking in the reinforced concrete structure and liner tears at the bottom of the walls. The staff found the pool structure to be strong enough to prevent liner tearing that could lead to leakage at any other location in the pool. Other components, including the refueling cavity gates and the piping attached to the SFP, whose failure could have increased the rate of coolant loss, were evaluated and found to be sufficiently strong and flexible enough to resist the ground motion without leakage.

**19) Comment:**

“The study must consider scenarios other than that involving a 1 in 60,000 year earthquake leading to complete draindown of a spent fuel pool. Just as Three Mile Island demonstrated the fallacy of the large-break loss of coolant shield, the extreme earthquake obsession does not answer all the relevant questions that must be answered”

**NRC Response:**

The study is a plant-specific analysis focused on the large seismic event shown by past studies to dominate risk , and is not a comprehensive search for vulnerabilities. The objective of this study was to provide a detailed accident progression analysis for a specific pool with additional sensitivity calculations to gain insights on potential radioactive releases from different loading patterns.

**20) Comment:**

“Page 11 of the draft study states

“The conditional probability of a Zircaloy cladding fire given a complete loss of water was found to be 1.0 for PWRs [pressurized water reactors] and 0.25 for BWRs [boiling water reactors] in high-density configurations based on differences in assumed rack geometry.” A 1.0 conditional probability means that there’s a 100 percent chance of a PWR spent fuel pool fire if it lost water. (Conditional probability literally cannot get any higher than that, yet it’s curiously been omitted from the draft study.)”

“In this, and too many other instances, when faced with multiple choices, the NRC picked a nonconservative, non-bounding option.”

“In this specific instance, the NRC must either examine a PWR spent fuel pool scenario in its final report or justify excluding a 100 percent conditional probability of fire along with its disastrous consequences”

**NRC Response:**

The study is a best-estimate analysis that did not intentionally bias the results in a conservative or non-conservative direction. The spent fuel pool study used a BWR as a reference plant for a detailed accident progression analysis resulting in a predicted range of releases. Therefore, any conclusions in the report only apply to the SFP considered in the study for a BWR with a Mark I containment. Any reference to PWR in the report is provided in the context of past studies in Section 1.7.

**21) Comment:**

“The final study must consider full core offloads (at least parametrically) – or the NRC should ban them from happening.”

**NRC Response:**

The rationale for choosing a "core shuffle" rather than a full core offload is because the former is the typical case for BWRs. Emergent core offloads later in the operating cycle are not typical (please see Table 3 for additional information). Moreover, the full core's decay heat is actually considered during the outage when the reactor and the SFP are hydraulically connected. The additional decay heat from the reactor is provided in Table 26 for OCP 1 and 2.

**22) Comment:**

“Table 3 of the study states that "Failure of nearby dams is not explicitly addressed." The disaster at Fukushima has been attributed to flooding from the tsunami caused by the earthquake rather than by earthquake damage directly. This study ignores that reality by assuming that an earthquake of severe magnitude likely to occur only once every 60,000 years (and yielding geometric mean acceleration of 0.7 g) has zero chance of causing nearby dam(s) to fail.”

**NRC Response:**

As mentioned in Table 3 of the report, failure of nearby dams is not expected to cause flooding above grade level at the reference plant. If flooding were to occur, efforts to mitigate the accident could be challenged.

**23) Comment:**

“The final study must not summarily dismiss the criticality concern associated with a high-density spent fuel pool”

**NRC Response:**

The NRC does not agree that this concern has been summarily dismissed. As discussed in Section 2.3, the offsite consequences of a criticality event are believed to be less severe than the consequences of a prolonged uncovering of the SFP, and are expected to be bounded by the results of this study.

**24) Comment:**

“It is not apparent from the information in Tables 8 and 9 that removing 55 percent of the mass from spent fuel pools has only positive safety margin implications.”

“The NRC must, as a minimum, explain qualitatively why it only considered one configuration in its seismic evaluations.”

**NRC Response:**

The difference in the weight of the spent fuel assemblies and mass of water between the two configurations while not negligible is not expected to lead to significant differences in the calculated probability of damage to the liner. The differences in the estimation of liner failure probabilities from differences in those quantities, which are small in the context of the total loads on the pool, are expected to be within the range of variability of the response predictions for these beyond design basis loads. The study assumed the same mass of water for the two configurations without reducing this mass to account for the volume of the assemblies in either case. This provides an upper bound on the mass of the water in the pool for both configurations.

From: Mack Sim (ADAMS Accession No. ML13211A175):

**25) Comment:**

“The exclusion of a refueling gate seal failure is unwarranted. There is no argumentation for this exclusion in the study (beyond baldly stating such an event is "unlikely") and no study or experiment to support this exclusion is cited.”

**NRC Response:**

The description of the gates system provided by the licensee of the reference plant to the study team during a site visit as well as engineering drawings shown by that licensee to the study team during the same site visit, showed that the gate facing the spent fuel pool has a backup gate with an air gap in between the two gates. Those description and drawings also showed that both gates have mechanical seals to prevent leakage. Passive mechanical means (i.e., do not depend on air pressure, ac power, or dc power) that are unlikely to fail under the earthquake conditions provide leaks tightness by keeping the seals pressured between the gates and walls.

**26) Comment:**

“Hydrogen production from steam radiolysis (specifically, steam radiolysis taking place in bubbles on the surface of fuel elements in a pool that has lost circulation cooling) is not considered, which leads to overly optimistic predictions [with respect to] probability and timing of hydrogen combustion events.”

**NRC Response:**

During a severe accident, cladding oxidation modeled in MELCOR is by far the most important source of hydrogen generation, and could be about two orders of magnitude higher than radiolysis (based on the decay heat levels in the SFP used in this study). For the scenarios leading to hydrogen combustion in this study, the time required to get to ignition is only a few hours following the onset of significant heatup. In case of boiloff scenarios, the time required to generate sufficient hydrogen to cause combustion is much longer than the 72 hour truncation time considered, and the significant steam generated during boiloff events would act to temporarily inert the building.

From: EDF - France (ADAMS Accession No. ML13225A582):

**27) Comment:**

“the study is performed for a BWR nuclear reactor, can you give us the characteristics of the fuel assembly (type, pitch, enrichment, weight) and the name of the nuclear power plant?”

**NRC Response:**

Table 15 provides the information on the assembly type. The study used Peach Bottom as a reference and used all of the available plant specific design and operational data.

**28) Comment:**

“we would like to know the irradiation history of the fuel assemblies (burnup, number of irradiation cycle and intercycle, length of irradiation and intercycle in days)”

**NRC Response:**

As indicated in the Response to Comment # 27, this information is proprietary. But such information was used to calculate the radionuclides inventories as explained in Section 6.1.5 of the report.

**29) Comment:**

“the study considers configuration 1x4 and 1x8 (one hot fuel surrounded by 4 or 8 cold fuel), according to you is it possible to store spent fuel like these configurations (are all the permutations of fuels practically manageable in exploitation)?”

**NRC Response:**

In fact, Peach Bottom uses a 1x8 loading pattern, where most plants employ a 1x4 loading pattern. In the study, the base case used Peach Bottom plant data with a 1x4 loading pattern. The 1x8 loading pattern used at Peach Bottom was analyzed as a sensitivity and had more favorable results, in terms of coolability and radiological releases than a 1x4 loading pattern, although both are safe arrangements in terms of public health and safety.

**30) Comment:**

“for the configuration 1x4 high density, could you give us the spent fuel heat (KW) for hot and cold fuel?”

**NRC Response:**

Table 25 of the report provides a comparison of various decay heat levels (averaged over a number of assemblies).

**31) Comment:**

“the study concludes that for BWR fuel assemblies, the latent cancer fatal risk is very low. According to you, would the conclusion be similar if the study had been performed for PWR fuel assemblies? Is BWR more conservative than [PWR] for this study?”

**NRC Response:**

The results of this study only apply to the reference plant (BWR Mark I) SFP. However, Section 10 provides a comparison of the consequences of this study and past spent fuel pool analyses (see Table 62 for latent cancer fatalities information).

**32) Comment:**

“Figure ES-1 shows that for small leak without mitigation measures, maximum release are 42% Cs for high density and 3.1% for low density. How can you explain that the latent cancer fatal risk is similar and very low for the two cases although there is a great release of Cs for high density? What are your assumptions for the radiological consequences study on the population?”

**NRC Response:**

The consequence analysis includes evacuating and relocating people. Therefore, the predominant outcome of the SFP release is land contamination, rather than public health effects, because emergency planning procedures are assumed to be effective in reducing dose to the public under both scenarios.

Section 7 of the report provides a more detailed explanation of the study for offsite consequences. Section 7.2.2 discusses the individual latent cancer fatality risk.

**33) Comment:**

“did the study take into account a propagation of zirconium fire (Sandia National Laboratory experiment)?.”

**NRC Response:**

Yes. The model development was based on validation of MELCOR against the BWR zirconium fire experiments as documented in NUREG/CR-7143.

**34) Comment:**

“could you briefly explain what the 10 CFR 50.54(hh)(2) mitigation measures are?”

**NRC Response:**

Each NRC reactor licensee must develop its own set of strategies to mitigate the effects of potential explosions or fires, and such strategies must include those relating to fire fighting, the mitigation of fuel damage, and minimizing radiological releases. As discussed further in Section 5.3 of the report, to meet the 10 CFR 50.54(hh)(2) requirements, licensees typically rely on equipment such as additional electrical power sources and pumps to provide water to the SFP for cooling the spent fuel (as was required by NRC orders after the terrorist attacks of September 11, 2001).

**35) Comment:**

“Finally, in your conclusion you say that 'Analysis also shows that for the scenarios and spent fuel pool studied, spent fuel is only susceptible to a radiological release within a few months after the fuel is moved from the reactor into the spent fuel pool. After that time, the spent fuel is coolable by air'. Can you explain this phenomenon and particularly the assumptions that you made to conclude that the spent fuel is coolable by air? What are the spent fuel heats after a few month of storage in the pool?”

**NRC Response:**

In an unlikely event of a liner failure in the reference plant SFP, the structural analysis in Section 4 predicts the leakage to occur at the bottom of the pool. Without successful deployment of mitigation, the leakage will lead to an eventual draining of all water in the pool. This leads to the natural circulation of air through the fuel assemblies. The timing of a potential zirconium fire is based on detailed accident progression analysis documented in Section 6 of the report. While releases are predicted for OCP3 (see page 142), a zirconium fire is not predicted in OCP4 (see Figures 52-57). Therefore, the spent fuel is coolable by air for at least 72 hours in OCP4. Table 25 of the report provides a comparison of various decay heat levels (averaged over a number of assemblies).

**36) Comment:**

“Is there any containment protection in the pool?”

**NRC Response:**

The spent fuel pool is open to the refueling room as shown in Figure 42. The refueling room is part of the reactor building adjacent to the reactor containment. This building is not designed to withstand elevated pressures. Page 107 of the report provides a description of the reactor building and the failure pressure criteria for the blowout panels and the roof. Section 4 of the report provides more details on the reactor drywell and the spent fuel pool.

From AGREE New York (ADAMS Accession No. ML13217A130):

**37) Comment:**

“The Draft study is not responsive to the Court's specific direction in June 2012 regarding what must be thoroughly evaluated.”

“However, the Court decision in June 2012, US Court of Appeals for the District of Columbia Circuit, concerning NRC's waste confidence decision, required NRC to thoroughly evaluate the following:

1. the environmental effects of failing to secure permanent disposal
2. the risks of spent fuel pool leaks
3. the consequences of spent fuel pool fires.”

**NRC Response:**

The purpose of the SFPS is to determine whether accelerated transfer of older, colder spent fuel from the spent fuel pool at a reference plant to dry cask storage significantly reduces risks to public health and safety.

A separate NRC activity, the ongoing Waste Confidence rulemaking, will respond to the June 2012 decision by the U.S. Court of Appeals for the District of Columbia Circuit that vacated and remanded the NRC's Waste Confidence Rule. The Waste Confidence rulemaking will address the three deficiencies the Court—and the commenter—identified.



For more information about the Waste Confidence rulemaking, visit <http://www.nrc.gov/waste/spent-fuel-storage/wcd.html>.

**38) Comment:**

“A number of scientific studies have been completed by the Nuclear Regulatory Commission and the National Academy of Sciences which document the severity of the problems of overcrowded spent fuel pools and the potential catastrophic risks. This body of scientific work, which includes that of Allison Macfarlane, the current Commission Chairperson, cannot now simply be ignored by the NRC.”

**NRC Response:**

The SFPS builds upon numerous past studies of spent fuel pool risk as discussed in Section 1.7 of the report.

From: Charles Pennington (ADAMS Accession No.ML13217A132):

**39) Comment:**

“I question the use of such highly conservative “safety analysis” codes (thermal, structural, source and release calculations, especially in the dispersion, inhalation, ingestion, direct dose rates, population dose, etc. determinations)”

“It appears there has been no “sanity check” of the individual case results with an actual event such as Chernobyl”

“Such inconsistencies and significant modeling conservatisms should be carefully reviewed as to whether the displayed results are consistent with the modeling (a good QA review is probably in order) and whether they should appear in this report as has been said by others, these results are not hyper-conservative; they are wrong.”

“It would seem logical, if modeling is the issue here (such safety analysis models classically being unable to project reasonable outcomes, which is especially troubling when used to discuss BDB events with the public), that for at least the dose consequence portion of the analyses, simple use of Chernobyl correlations would result in still conservative dose projections without the need to overstate impacts on the public; I have developed correlation models myself for that purpose, and that is the course I would recommend.”

**NRC Response:**

The accident progression analysis contains no intentional conservatisms. MELCOR and MACCS2 represent state of the art codes for evaluation of accident progression and accident consequences, respectively.

MELCOR is the NRC's best estimate tool for severe accidents analysis, and has been validated against experimental data. MELCOR has the capability to mechanistically model deposition of aerosols on the structures within the reactor building. This is factored into the building decontamination factor as shown in Figure 86. Section 6.1.1 of the report details the modeling approach used for this analysis including the experimental basis for the breakaway

oxidation kinetics model as well as other required models when modeling SFPs. The zirconium fire experiments were used to help validate MELCOR (see NUREG/CR-7143). The code's predictions showed good agreement with the experimental data for the initiation and propagation of zirconium fire.

The MACCS2 code has been compared to a number of alternate atmospheric transport and deposition codes. These include: Gaussian puff models and a state-of-the-art Lagrangian particle tracking code, for estimating concentrations and deposition out to distances as great as 100 miles from the point of release. The study was documented in NUREG-6853. Generally, MACCS2 performed as well as either of the Gaussian puff models when compared with the state-of-the-art Lagrangian code for calculating mean consequence results.

Extrapolation from the results of historical releases of radioactivity to the environment, such as the Chernobyl accident, to yield estimates of the exposures and risks of fuel pool accidents would require great care in order to yield valid insights. This is due to major differences in source term characteristics (e.g., heat content, aerosol characteristics), transport characteristics, and exposure factors (such as, shielding factors, dietary habits, and protective action strategies). However, the NRC is participating in a number of international and domestic efforts underway to benchmark codes against available Fukushima data, although releases from spent fuel pools were not experienced and therefore not available for comparison.

**40) Comment:**

"The fact that the most highly regarded nuclear regulatory body in the world still uses LCFs is simply beyond credulity."

**NRC Response:**

Individual latent cancer fatality (LCF) risk is computed to provide a perspective on how the accident evaluated in the report could affect societal risks. Such use of LCF risk data is consistent with the NRC safety goal policy statement.

**41) Comment:**

"Finally, I would suggest that some part of the report provide more discussion of the doses generated by the events and the risk issue, as well as offering the public a comparison of the collective doses from this report with the collective doses the public receives every year from a selection of non-nuclear industries (out of the 15 to 20 that are most impactful on U.S. population doses)."

**NRC Response:**

The NRC Safety Goal regarding LCF risk from nuclear power plant operation (i.e.,  $2 \times 10^{-6}$  or 2 in 1 million per year) is set 1,000 times lower than the sum of cancer fatality risks resulting from all other causes (i.e.,  $\sim 2 \times 10^{-3}$  or 2 in 1 thousand per year). As discussed further in the report's Executive Summary, this study estimated that the likelihood of a radiological release from the spent fuel pool resulting from the selected severe seismic event the study analyzed is on the order of one time in 10 million years or lower. This in part is a reason why the LCF risks within 10 miles in this study are low, in the range of one in a trillion (10<sup>-12</sup>) to 1 in 10

billion (10<sup>-10</sup>) per year for the analyzed scenario. Comparisons of the individual LCF risk within 10 miles calculated in this study to the NRC Safety Goal are provided in Figure ES-3. Such comparisons provide context that may help the reader to understand the contribution to cancer risks from the accident scenarios that were studied. The results of this study are scenario-specific and related to a single spent fuel pool. However, staff concludes that since these risks are several orders of magnitude smaller than the 2x10<sup>-6</sup> (2 in 1 million) individual LCF risk – which corresponds to the safety goal for latent cancer fatalities – it is unlikely that the results here would contribute significantly to a risk that would challenge the Commission's safety goal policy.

From: Electric Power Research Institute (ADAMS Accession No. ML13217A133):

**42) Comment:**

“The SFPS is a consequences analysis as opposed to a full risk assessment. This is highlighted and acknowledged in the title as well as several times throughout the report. A more comprehensive probabilistic evaluation, while more resource intensive, would provide greater refinement and insight and increase the usefulness of the study, such as in risk-informed regulatory activities.”

**NRC Response:**

This study is intended to provide a detailed assessment of the consequences associated with spent fuel pool accidents, and to compare the consequences of high and low density pool configurations. Although the study did not examine all scenarios typically considered in a probabilistic risk assessment (PRA), it focused on a large seismic event (beyond the design-basis for the plant) because past studies have suggested that this is the largest contributor to SFP risk. In fact, any analytical technique, including PRA, will have inherent limitations of scope and method. Nevertheless, the staff is currently performing a comprehensive site Level 3 PRA for a US PWR as discussed in SECY-11-0089.

**43) Comment:**

“The SFPS acknowledges the potential for interactions between the reactor and the spent fuel pool, and identifies such interactions in Section 2.2. These interactions are not, however, evaluated within the scope of the study. This decoupling of the SFP from the reactor affects several parameters including the potential for hydrogen from a reactor accident to collect in the SFP area, with the possibility of combustion; the timing of assumed operator actions; and the timing of the general emergency order (potential to affect evacuation). Additional discussion or basis would be helpful.”

**NRC Response:**

Although such interactions between the reactor and SFP may be significant, they are outside the scope of the current study. The possibility that a concurrent reactor event may preclude operator actions is part of the motivation for the "unmitigated" cases analyzed in the study. Further, Section 9.4 presents sensitivity calculations to show the importance of the reactor building in the progression of accidents in the SFP and the source term with a concurrent reactor accident. Moreover, the full core's decay heat is actually considered during the outage when the reactor and the SFP are hydraulically connected.

Additionally, as noted above, the staff is currently performing a comprehensive site Level 3 PRA for a US PWR as discussed in SECY-11-0089.

**44) Comment:**

“The report assumes a uniform spray flux of water over the top of the SFP. Depending on timing and locations at which operator actions would need to be taken (e.g., proximity to pool and radiation fields), it may be difficult to align the spray. It could also be difficult to achieve 100% coverage if debris has blocked the top of some fuel assemblies.”

**NRC Response:**

The study analyzed scenarios with and without successful deployment of mitigation and thus reasonably characterizes the range of possibilities. Some aspects of the mitigation success are provided in Section 8 in the HRA analysis. As stated in Table 3 of the report, no significant debris generated by the seismic event is expected to enter the SFP based on the structural response of the building and overhead crane. In addition, as stated in Table 3, some debris could be generated and could fall into the pool as a result of hydrogen combustion. However, the occurrence of a hydrogen combustion event in this study denotes that the fuel in the SFP has already become uncovered and is undergoing a fission product release.

**45) Comment:**

“The option to spray into the SFP from outside the Reactor Building is possible if the refueling floor is open to the environment. Depending on the size of the assumed opening, this option could limit the ability to achieve full spray coverage of the pool, but might be more likely to result in atmospheric scrubbing of the radionuclides”

“Spraying into the refueling floor and spent fuel pool from an external position creates the potential for direct release to the environment that is not currently included. Any operator actions to ventilate the building are considered should be considered in this context as well.”

“The report indicates that “for PBAPS, the capacities of the available equipment are somewhat higher. The use of ... 200 gpm here attempts to account for uncertainties in the ... spray that goes outside the boundary of the pool”. However, it is not clear whether this particular conservatism could balance the potential lack of full spray effectiveness noted above.”

**NRC Response:**

The study analyzed scenarios with and without successful deployment of mitigation which reasonably characterizes the range of possibilities. Section 8 in the HRA analysis provides some aspects of the mitigation success.

Regarding the comment on considering operator action to ventilate the building, and the need to capture the associated direct radiological release to the environment that might accompany this, the study did not consider negative or positive impacts of operator actions associated with ad hoc measures to ventilate the building. This is in keeping with the approach of focusing on mitigation measures covered by 10 CFR 50.54(hh)(2) (and more

specifically those in the NRC-endorsed guidance document NEI-06-12, Revision 2). When modeled actions or phenomenologically-driven events did affect radiological release characterization (e.g., spray scrubbing, hydrogen combustion-induced building damage), these effects were mechanistically modeled.

**46) Comment:**

“Air cooling of the assemblies is dependent upon having clear channels for air flow. Debris from the Reactor Building superstructure or miscellaneous equipment on the refueling floor could conceivably fall into the pool, potentially damaging the liner or impeding local air flow in the SFP channels. The analysis does not consider debris interaction with the SFP resulting either from a large seismic event or from a hydrogen combustion event (see Section 1, Table 3 for technical basis). Additional technical justification or a sensitivity analysis may be desirable. We do note that experience from recent large seismic events, including Kashiwazaki-Kariwa 2007, Fukushima Daiichi, Fukushima Daini, Onagawa, and North Anna, indicates little or no debris generation and deposition into SFPs due to earthquake itself.”

**NRC Response:**

The occurrence of a hydrogen combustion event associated with the spent fuel itself in this study denotes that the fuel in the SFP has already become uncovered and is undergoing a fission product release. The reduction in flow area and losses associated with debris generated from a hydrogen combustion resulting from a reactor accident is explicitly considered in Section 9.4 of the report.

No significant debris generated by the seismic event is expected to enter the SFP based on the structural response of the building. In addition, as stated on page 25, some debris could be generated and could fall into the pool as a result of hydrogen combustion.

**47) Comment:**

“The reports states that “The cool gases leaving the lower regions of the building are not brought into thermal equilibrium with gases above the SFP.” (Page 107). This assumption allows for cooler air at the inlet of the fuel. In order to achieve the lower inlet temperatures other actions may be necessary such as opening doors or other access ways to enhance airflow. It may be useful to provide additional justification or sensitivity analysis.”

“Only the refueling floor is modeled in MELCOR (pp. 105, 107, 108). The equipment shaft from lower Reactor Building elevations is modeled as supplying the air inlet to the SFP. This leads to air temperatures lower than what might be expected. In practice, air ingress into the SFP racks may be limited by the flow area available into the bottom of the pool and the air temperature may be higher than assumed. A sensitivity evaluation may be useful to address this issue.”

**NRC Response:**

The analysis has shown that during the heatup of the fuel and especially during natural circulation once the baseplate clears, the atmosphere of the refueling room becomes very hot and the flow is out through the normal leakages and the open hatch region to maintain the pressure. If the reactor building is intact, oxygen is eventually depleted that would limit

the oxidation of remaining cladding. If ventilation is established in time before significant heatup of the fuel, it is possible to prevent a zirconium fire; however, if ventilation comes late, then air ingress would supply additional oxygen that would lead to additional oxidation. Some of these insights can be inferred from Figures 130 and 131 in Section 9.4 of the report.

**48) Comment:**

“The crack in the concrete and the tearing of the liner are assumed to occur at the bottom of the SFP. The complete draining of the pool opens the possibility for air cooling, which could be reduced if the leak occurred above the bottom of the fuel. The impact of this assumption can be estimated where fuel assembly inlet flow is delayed, which results in higher fuel temperatures. Further discussion of this particular assumption would be useful.”

**NRC Response:**

Please see the response to Comment #18.

**49) Comment:**

“The SFPS acknowledges the large uncertainties for several assumptions associated with location and size of the breach (e.g., finite element modeling of the concrete structure, modeling of the liner strain, modeling of the liner tear and the concrete cracking that would allow leakage flow, and calculation of the friction factor associated with the leakage pathway). Sensitivity calculations could be used to investigate the possible impact of changes to failure location or size. A more probabilistic treatment could produce more refined results.”

**NRC Response:**

The size and location of the leak were not assumptions made by the staff in the study. As discussed in Section 4 of the report, the structural analysis of the reference spent fuel pool design predicted the liner tear to be at the bottom of the pool for two leak sizes with a range of draindown times. For the SFP studied the uncertainty on the location of the concrete cracking and liner tearing is small. The study acknowledges that uncertainties on the water leakage rate are high. Consideration of two significantly different leakage rates and associated draindown times addresses the consequential range of those uncertainties. Please also see the response to Comment # 18.

**50) Comment:**

“The study predicts cesium releases following hydrogen combustion (approximately 18 hours into the accident) in high density loading but not in low density loading. The difference in outcome is associated with the higher hydrogen concentration in the base case (high density loading).”

**NRC Response:**

The NRC staff agrees. None of the low density cases produced enough hydrogen to initiate a hydrogen deflagration even though sufficient oxygen was present to sustain combustion.

**51) Comment:**

“The MELCOR calculation does not predict that hydrogen combustion will take place on the refueling floor. This result may be influenced by not including the entire reactor building in the model. A sensitivity study that accounts for sufficient oxygen from other parts of the building may produce additional insights.”

**NRC Response:**

For high density cases, MELCOR predicts hydrogen deflagration in the refueling bay (see the sensitivity to hydrogen combustion in Section 9.1 on the report).

**52) Comment:**

“The SFPS “did not consider hydrogen events originating from a concurrent reactor accident”.”

**NRC Response:**

Hydrogen combustion is considered as a part of the sensitivity analysis in Section 9.4 of the report.

**53) Comment:**

“Molten core concrete interactions (MCCI) at the bottom of the pool can result in higher release fractions for radionuclides. MCCI can also lead to hydrogen generation. While the sequence is very unlikely, some discussion in the analysis may be warranted.”

**NRC Response:**

The sensitivity with MCCI in Section 9.5 of the report was focused on the releases and chemical form of the radionuclides. This sensitivity assumed that the reactor building has already failed as a result of a concurrent reactor accident. The limitations of representing MCCI in SFPs using MELCOR are also discussed on page 222 of the report. Nevertheless, the large scale fuel damage and relocation occurs mainly for small leak scenarios, and in most cases, the reactor building is expected to fail as a result of the hydrogen generated from the spent fuel before the start of MCCI.

**54) Comment:**

“If the conditions of the reactor do not warrant prompt declaration of a General Emergency (GE) based on the emergency action limits (EALs), then the time to initiate public evacuation could be delayed. Generally, EALs do not include guidelines for declaring a GE for events involving the SFP. For irradiated fuel or SFP events the highest EAL is alert, although a GE is declared by the emergency director.”

**NRC Response:**

In general, staff acknowledges that uncertainty can be associated with the timing of protective actions (such as sheltering and evacuation). However, staff expects the specific

site conditions assumed (those being the loss of all off-site and on-site ac power that is not expected to be restored for a prolonged period of time) would promptly warrant declaration of a GE, and that this would occur before other potential conditions arose. Also, staff notes that the largest releases from the baseline results in this study arise from slow leaks, and these releases offer relatively long periods (40 hours or more) prior to the onset of release. Because of these reasons and others, the results of this analysis are not expected to be very sensitive to the exact time of the GE declaration.

**55) Comment:**

“The conclusion that there are no calculated early fatalities would benefit from further discussion”

**NRC Response:**

Staff has identified some of the factors that, in its professional judgment, contribute to the modeled result of no early fatalities. Staff believes that this is due in part to the efficacy of protective actions such as sheltering, evacuation, and relocation, although staff acknowledges that other factors, such as the isotopic composition and duration of the release, may play an important role as well.

Staff believes that the results of the study are consistent with the NUREG-1738. For example, Appendix A4B of NUREG-1738 provides computed early fatalities as a function of time since shutdown for both high and low ruthenium source terms and for early vs. late evacuation. The largest numbers of early fatalities reported in Appendix A4B of NUREG-1738 are associated with releases shortly after shutdown, a 75% Ru release, and late evacuation of 95% of the population. The NUREG-1738 results for the lower Ru release and early evacuation all show substantially less than one early fatality.

Moreover, with respect to the potential effect of evacuation uncertainty on computed early fatalities, staff notes that detailed outputs of SFPS's consequence simulations include a cohort representing the 0.5 percent of the population that is assumed to not evacuate, although they are assumed to be subject to dose-dependent relocation following plume passage. These detailed results show that even for those who are not assumed to evacuate, no early fatalities are computed for any of the releases evaluated. Staff believes this result supports the view that uncertainties in the evacuation model are not likely to significantly affect the conclusion that the risk of early fatalities from spent fuel pool accidents is very low.

In summary, although a detailed analysis of the factors leading to the result of no early fatalities could be instructive, the staff believes that the results reported are reasonably robust and are adequate to support the conclusions of the report.

**56) Comment:**

“The portable equipment for mitigation is assumed to be available and able to be aligned to the SFP despite the potential priority use on the reactor.”



**NRC Response:**

The study analyzed scenarios with and without successful deployment of mitigation, and thus it reasonably characterizes the range of possibilities.

**57) Comment:**

“The work area to align the equipment is assumed to be accessible despite the draining of the SFP, potential high radiation, and potential loss of building structural integrity.”

**NRC Response:**

The study analyzed scenarios with and without successful deployment of mitigation that reasonably characterizes the range of possibilities.

**58) Comment:**

“The applicability of the HRA approach to the conditions of interest in the main report and appendices may merit some additional justification.”

**NRC Response:**

The combination of SPAR-H and expert judgment approach to the HRA is appropriate for the study. Further refinement to the analysis would require performing a probabilistic risk assessment which is outside the scope of this analysis.

**59) Comment:**

“The main report and the associated detailed analysis are a very useful compendium of methods and associated results for the chosen scenario. However, extrapolating the analysis of this single scenario to the risk conclusions drawn in Appendix D introduces large uncertainties and additional assumptions. Explaining and quantifying these uncertainties should be considered.”

**NRC Response:**

The objective of this report is to study the consequences of a beyond design basis earthquake on a representative spent fuel pool in two configurations, low and high density at the reference plant. This analysis uses information contained within the study, to evaluate whether the reference plant in the study will benefit from the change from high- to low-density storage configurations in the spent fuel pool.

This analysis calculates the potential benefit per reactor year resulting from expedited fuel transfer by comparing the safety of high-density fuel pool storage relative to low density fuel pool storage. The comparison uses the initiating frequency and consequences from the Spent Fuel Pool Study to indicate whether any changes in the NRC’s understanding of safe storage of spent fuel are warranted. Given the uncertainties involved in performing this plant-specific regulatory analysis, low and high estimates were used to supplement the best estimate. For areas in which there was large uncertainties, a bounding approach was used. The staff also used calculated results from previous spent fuel pool studies (i.e., NUREG

1353 and NUREG-1738) to extend the applicability of this evaluation to include other initiators, which could challenge spent fuel pool cooling or integrity.

Appendix D discusses the methodology, inputs, and assumptions used.

**60) Comment:**

“With respect to insight #3 on p. 246, the “informed expectation” has not been compared against an accepted seismic hazard curve. While the analysis still provides insights, a more traceable seismic hazard would improve the study.”

**NRC Response:**

The seismic hazard used in the study was derived using the USGS 2008 seismic hazard model. The hazard information is provided in Chapter 3 of the report, specifically in Figure 2 and Table 4. The seismic hazard curve provides hazard information for peak ground accelerations up to 1.0 g while Table 4 also provides information on the expected hazard for all events with peak ground accelerations greater than 1.0 g. The information in Figure 2 shows that the seismic hazard curve used in the study predicts higher seismic hazards for events with peak ground accelerations greater than about 0.4 g than the hazard curves used in past NRC studies. These higher hazards informed the selection of the seismic event for the study.

Additional seismic hazard information is expected to be developed by licensees and submitted to the NRC for review as part of licensees’ responses to the NRC information request for resolution of the Fukushima Near-Term Task Force Recommendation 2.1: Seismic. When completed, reviewed and published that new hazard in conjunction with the results of the Spent Fuel Pool Study, is expected to provide further insights on seismic hazard issues.

**61) Comment:**

“With respect to insight #5 on p. 246, the case is made that the hottest fuel should be stored in 1x8 patterns to minimize the time air cooling would not be effective. This insight was not the focus of the analysis and could benefit from further review or additional discussion to indicate the expected risk impact.”

**NRC Response:**

The 1x8 sensitivity calculations were performed based on the reference plant’s practice of fuel loading in this configuration. Conclusion 5 summarizes the advantages associated with dispersed fuel loading patterns (both 1x4 and 1x8). As the commenter points out, detailed analysis of the risk impact of the 1x8 loading pattern was not the focus of the study and is beyond its scope.

**62) Comment:**

“With respect to insight #17 on p. 249, the statement is made that “The risk due to beyond design basis accidents in the spent fuel pool analyzed in this study is sufficiently low that the added costs involved with expediting the movement of spent fuel from the pool to achieve the low-density fuel pool storage alternative are not warranted.” This insight is not well supported by the main report because a comprehensive risk assessment has not been performed in the main report. Referencing Appendix D would be needed along with all of the assumptions and inputs used in Appendix D.”

**NRC Response:**

As the comment indicates, Conclusion #17 is supported by the regulatory analysis and backfitting discussion in Appendix D of the report. Conclusion #17 is subject to the analysis model, data, inputs and assumptions in Section D.3 of Appendix D . This clarification has been made in Conclusion #17 the report.

**63) Comment:**

“To enhance the existing study some additional sensitivity cases and additional investigations may be useful, including:

- i. Sensitivity of hydrogen combustion (MELCOR)
- ii. Sensitivity of 1x fuel assembly pattern (MELCOR)
- iii. Sensitivity to a contiguous(uniform) fuel pattern during an outage (MELCOR/MACCS2)
- iv. Sensitivity to concurrent reactor accident (MELCOR) (loss of Reactor Building)
- v. Sensitivity to SFP leakage location and magnitude (MELCOR/MACCS2)
- vi. Sensitivity to molten core-concrete interaction (MELCOR/MACCS2)
- vii. Sensitivity to radiative heat transfer (MELCOR) (low density case)
- viii. Sensitivity to land contamination (MACCS2)
- ix. Sensitivity to time truncation (MELCOR/MACCS2)
- x. Sensitivity to Reactor Building leakage (MELCOR)
- xi. Sensitivity to 50-mile radius assumption (MACCS2)
- xii. Sensitivity to scenario duration (>72 hrs)

It seems appropriate that the sensitivities should also address whether these could affect the cost-benefit assessment (e.g., would they affect both configurations in a manner that the differences in consequences apply equally?).”

**NRC Response:**

These sensitivity calculations have been performed and documented in the report. The purpose was to show the range of responses that would be expected, and in some cases, the results were bounded by the results for the base case.

From: State of New York, Office of the Attorney General (ADAMS Accession No. ML13217A134):

**64) Comment:**

“As an initial matter, the State reiterates its request for more time to provide comments on this long-term Draft Study”

**NRC Response:**

Because this is a research study we did not extend the comment period. This research study does not authorize any licensee action or set regulatory requirements. This study also does not establish any Commission policy. The comment period was appropriate for a research study and provided sufficient opportunity to receive comments..

**65) Comment:**

“The State is concerned with the study's failure to perform a benchmarking or bounding analysis.”

**NRC Response:**

The study is a best-estimate analysis that did not intentionally bias the results in a conservative or non-conservative direction. This study is intended to provide an estimate of the consequences from a postulated SFP accident in part to inform a regulatory analysis comparing the costs and benefits of expediting the transfer of fuel from the pool to dry cask storage. A bounding consequence analysis would have been less useful for this purpose.

**66) Comment:**

“The Draft Study relies upon assumptions that underestimate the likelihood of a spent fuel pool accident. For example, the Draft Study assumes that liner damage is the only way to cause a radiological release. Thus, the Draft Study fails to address other ways cooling water could be lost, such as water boil-off. Instead of examining partial boil-off and partial drain-down, the study focuses solely on rapid drain-down.”

**NRC Response:**

The study did not analyze a partial draindown, which would correspond to a leak on the walls of the SFP, because the staff's structural analysis for the reference pool studied showed that the walls are not potential leak locations. As discussed in Section 4 of the report the structural analysis predicted the earthquake would cause relative motion between the pool walls and the pool floor that would have the potential to result in cracking in the reinforced concrete structure and a liner tear at the bottom of the walls. The staff found the pool structure to be strong enough to prevent liner tearing that could lead to leakage at any other location in the pool. Other components, including the refueling cavity gates and the piping attached to the SFP, whose failure could have increased the rate of coolant loss, were evaluated and found to be sufficiently strong and flexible enough to resist the ground motion without leakage.

The study investigated loss of water from boil-off, which did not lead to any releases in 72 hours after the earthquake. For the complete drain down, the study analyzed two cases, the moderate leak case, which leads to drain down in a few hours, and the small leak case, which leads to drain down in about 2 days. Based on the structural analysis performed, partial drain downs are not considered credible mechanisms for the reference SFP used in this study under severe earthquake conditions.

**67) Comment:**

“the Draft Study fails to address the impact of a prolonged loss of power. As the events at the Fukushima facilities demonstrated, natural disasters often cause prolonged power loss and equipment failures, and such events at multi-unit sites can have synergistic and cascading consequences; therefore, it is important for NRC to conduct an in-depth study of the consequences of such occurrences.”

**NRC Response:**

The study analyzed scenarios with and without successful deployment of mitigation. All the scenarios without successful deployment of mitigation assumed a prolonged loss of power.

**68) Comment:**

“Additionally, the offsite consequence analysis in section 7 of the Draft Study is flawed. In particular, the Draft Study fails to use realistic input values for its MACCS2 analysis. For example, the Draft Study unreasonably relies upon "Sample Problem A" generic values developed decades ago for the Surry site in rural Virginia. Instead, Staff, in drafting the study, should have developed site-specific MACCS2 input values. The Draft Study underestimates land contamination, land interdiction, and displaced individuals.”

**NRC Response:**

This study used input values specific for the analyzed reference plant.. The input parameters for the consequence analyses are based on those developed for Peach Bottom for the recently completed “State-of-the-Art Reactor Consequence Analyses” research project (NUREG-1935), as discussed in Chapter 7. Examples of site specific input parameters used include site specific population distributions, meteorology, and evacuation timing parameters including the effects of seismic events on local road networks.

**69) Comment:**

“The State recommends that the NRC clarify the differences between Peach Bottom and other U.S. nuclear reactors, and that it make clear that the Draft Study is limited to the reference plant and not necessarily indicative of conditions at other plants.”

**NRC Response:**

Section 1.3 of the SFPS report is devoted to explaining the use of the reference plant. In addition, the report makes clear in the Executive Summary and Conclusions that “The regulatory analysis for this study indicates that expediting movement of spent fuel from the pool does not provide a substantial safety enhancement for the reference plant. The NRC plans to use the insights from this analysis to inform a broader regulatory analysis of the

spent fuel pools at all US operating nuclear reactors as part of its Japan Lessons-learned Tier 3 plan.”

This study is intentionally based on plant-specific information for a particular site, as opposed to attempting to define a generic site that might bound a set of plants. This approach was taken because it provides the best context for examining SFP accident progression and release phenomenology in a realistic fashion, for the purpose of providing a better understanding of the factors that affect the characterization of SFP beyond-design basis accidents.

**70) Comment:**

“Finally, the State submits that the Draft Study's conclusion-that "expediting movement of spent fuel from the pool does not provide a substantial safety enhancement for the reference plant" is not adequately supported or explained in the Draft Study.”

“The Draft Study does not give proper weight to the substantial benefits associated with low density spent fuel pool storage.”

**NRC Response:**

Section D.5 of Appendix D, "Decision Rationale," explains that the low-density spent fuel storage alternative evaluated does not achieve a cost-beneficial increase in public health and safety for the reference plant using the current regulatory framework when all event initiators, which may challenge spent fuel cooling or pool integrity, are considered. Moreover, the three sensitivity studies provided in Section D.4.1.4 also showed that the low-density spent fuel storage alternative was not cost-justified for any of the discounted sensitivity cases.

The NRC also conducted a backfit analysis for the reference plant relative to the backfit requirements in 10 CFR 50.109. The NRC does not conclude that this alternative results in a cost-justified substantial safety enhancement for the reference plant. First, the risk of a spent fuel pool accident at the reference plant appears to meet the Safety Goal Policy Statement public health objectives. The estimated spent fuel pool accident release frequency also is less than the  $1 \times 10^{-5}$  per reactor-year Large Early Release Frequency guideline. Second, the cost-justified criteria are not met when evaluating the averted accident consequences within 50 miles of the site consistent with the regulatory framework. Sensitivity analyses that extend the analyses beyond 50 miles also show that the low-density spent fuel storage alternative was not cost-justified for any of the discounted sensitivity cases. Therefore, the Regulatory Baseline is justified for the alternative described in Section D.2.2 as evaluated for the reference plant.

In light of the findings above, the NRC concludes that the quantified safety benefits of the potential regulatory action provisions that qualify as backfits, considered in the aggregate, would not constitute a substantial increase in protection to public health or safety or the common defense and security. In addition the costs of this potential action would not be justified in view of the increase in protection to safety and security provided by the backfits embodied in the potential regulatory action.

From: Nuclear Energy Institute (ADAMS Accession No. ML13217A129):

**71) Comment:**

August 1, 2013 letter from Steven Kraft on behalf of NEI.

**NRC Response:**

This letter reflects on the study from NEI's perspective, but does not contain any request for changes or clarifications. Thus, no response is provided here.

From: State of Vermont, Department of Public Service (ADAMS Accession No. ML13217A131):

**72) Comment:**

"...the comment period be extended to allow for an adequate review of a complicated study."

**NRC Response:**

Because this is a research study we did not extend the comment period. This research study does not authorize any licensee action or set regulatory requirements. This study also does not establish any Commission policy. The comment period was appropriate for a research study and provided sufficient opportunity to receive comments..

**73) Comment:**

"First, the study finds that there is an increased risk of a radiological release from a spent fuel pool within the first few months after fuel is moved from the reactor into the spent fuel pool. The Department thus requests that the NRC research all measures that can be taken by nuclear power plants to reduce the risks of a radiological release during refueling when "hot" fuel is present in the spent fuel pool. The goal of the NRC should be to prevent any radiological release."

"Second, the study explicitly found that there are beneficial effects in the form of a reduction in offsite consequences, such as land contamination when a nuclear power plant moves from a high-density spent fuel pool loading scenario to a low-density scenario. Because measures can be taken to reduce the potential of land contamination which would also result in a reduction of radiation dose to the public and subsequent health effects, the NRC should consider immediately ordering reductions of spent fuel assemblies stored in a pool."

**NRC Response:**

NRC's regulatory framework is based on providing adequate protection of public health and safety. Land contamination is considered in the consequences and cost-benefit analysis. The results of this study and previous studies show that high density SFPs protect public health and safety in that the risk of an accident is low, and in the unlikely event of a SFP accident, no early fatalities are predicted and latent cancer fatality risk is low. The regulatory analysis in Appendix D of the report indicates that expediting movement of spent fuel from the pool does not provide a substantial safety enhancement for the reference plant. However, the NRC plans to use the insights from this analysis to inform a broader

regulatory analysis of the spent fuel pools at all US operating nuclear reactors as part of its Japan Lessons-learned Tier 3 plan. In addition, Orders EA-12-051 and EA-12-049 currently being implemented by all operating U.S. nuclear power plants should serve to further reduce spent fuel pool accident risk by increasing the capability of nuclear power plants to mitigate beyond-design-basis external events.

From: Mark Kelly (ADAMS Accession No. ML13219B156):

**74) Comment:**

“The NRC draft study depends on information that was generated using MELCOR in inappropriate ways. Even with input of reliable data, MELCOR produces accurate projections for systems only under circumstances and conditions that are understood and modeled well by the program. The NRC descriptions of its use of MELCOR indicate that the NRC attempted to use MELCOR to predict outcomes under circumstances and conditions that are beyond its current capabilities. MELCOR may be the best currently-available program for this type of study, but MELCOR capabilities don't appear to be up to performance standards required for this type of NRC study of accidents.”

“NRC relies on technical information from the nuclear industry, which sometimes fails to meet scientific standards necessary for studies to reliably inform decision makers. The NRC relied heavily upon industry data for the study. The NRC has failed to require the nuclear industry to maintain technical information on nuclear fuel rod cladding alloys and other materials.”

“The draft NRC report relies excessively on NUREGs and other information sources which themselves rely on information that may not have been adequately maintained.”

**NRC Response:**

MELCOR is the NRC's best estimate tool for severe accident analysis and has been validated against experimental data. Section 6.1.1 of the report details the modeling approach used for this analysis. The study relied on specific SFP models that have been integrated into MELCOR over the past 10 years. These models are supported by experimental data (e.g. new air oxidation kinetics as documented in NUREG/CR-6846). The comment states that NRC has relied only on technical information from the nuclear industry. This statement is not correct. For example MELCOR was validated against NRC-sponsored zirconium fire experiments conducted at Sandia National Laboratory (see NUREG/CR-7143). Please see the response to Comment #83 for additional discussion on the use of MELCOR in the study.

Plant specific design information for the study was provided by the licensee. In addition, NRC staff visited the reference plant to gather and verify plant information including interviews with plant staff regarding plant equipment and procedures.

NUREGs are NRC or NRC contractor reports that have been reviewed and approved for publication. Only credible information sources were used in the study.



**75) Comment:**

“Prior to publication of the Draft Consequence Study, NRC’s technical credibility on the pool-fire issue was low. Over a period exceeding three decades, NRC had published bad analysis and hidden other analysis behind a veil of secrecy. Moreover, NRC failed to conduct sophisticated modeling and supporting experiments that could have resolved technical issues central to pool-fire risk, despite having an appropriate capability prior to 1990.”

**NRC Response:**

This study provides updated, publicly available consequence estimates of a representative, postulated spent fuel pool severe accident from a beyond-design-basis earthquake under high-density and low-density loading conditions. MELCOR is the NRC's best estimate tool for severe accident analysis, and it has been validated against experimental data. Section 6.1.1 of the report details the modeling approach used for this analysis. The study relied on specific SFP models that have been integrated into MELCOR over the past 10 years. These models are supported by experimental data (e.g. new air oxidation kinetics as documented in NUREG/CR-6846). In addition, MELCOR was validated against NRC-sponsored zirconium fire experiments conducted at Sandia National Laboratory (see NUREG/CR-7143). Please see the response to Comment #83 for additional discussion on the use of MELCOR in the study.

The NRC conducted the SFP security assessments in a manner consistent with their sensitivity. The sensitive unclassified and classified analyses were made available to the Advisory Committee on Reactor Safeguards, the Government Accountability Office, and the National Academy of Sciences. None of those entities expressed concern with the classification of the SFP security assessments.

**76) Comment:**

“NRC’s Draft Consequence Study seeks to create the appearance of being a comprehensive assessment of the risk of a pool fire. That image is conveyed by the structure of the Study, by the way the Study is described in its Foreword, Abstract, and Executive Summary, and by unequivocal statements that high-density spent-fuel pools protect public health and safety. In fact, the Study’s scope is narrow. As a result, the Study’s examination of pool-fire risk is incomplete, and cannot support the broad, unequivocal findings that the Study presents. This disjunction between the apparent and actual scope of the Study is misleading. Moreover, in specific instances, the Study is misleading and is designed to support pre-determined conclusions.”

**NRC Response:**

The staff made clear throughout the report, (including in its Foreword, Abstract and Executive Summary), that the analysis and results are specific to a beyond-design-basis seismic event at a reference plant spent fuel pool connected to a boiling water reactor with a Mark I containment. For example, Chapter 2 of the report lists, in detail, the key limitations

and assumptions of the study, and states that the study is a limited-scope consequence study rather than a full PRA.

**77) Comment:**

“Pretence of considering low-density storage: The Study does not consider the risk implications of reverting to low-density, open-frame racks. Instead, NRC misuses the phrase “low density” in order to create a false impression of the Study’s scope. This pretence reflects pre-determined conclusions based on a “feeling”.”

**NRC Response:**

The comment does not specify how the phrase “low density” was misused, and the staff had no intention of creating a false impression of the study’s scope. Section 6.2 of the report describes in text and diagrams the staff’s modeling of high density and low density racking. The comment correctly states that the study did not look at open-frame racks. This was made clear in the report at page 23, that “to get the full benefit of low-density racking, BWR fuel would likely need to have the channel boxes removed.” Note that, for the reference plant, the BWR fuel assemblies channel boxes would impede crossflow even with open-frame racks.

**78) Comment:**

“Limited consideration of water-loss scenarios: The Study focuses its analysis exclusively on water-loss scenarios involving total drainage. By so doing, the Study ignores a substantial part of the pool-fire risk. For example, the Study makes no effort to determine how the presence of residual water could affect fuel ignition. Extrapolation of Study findings indicates that consideration of this issue would substantially increase the estimated risk.”

**NRC Response:**

The study considered the consequences of a very large earthquake at the reference plant. As discussed in Section 4 of the report the structural analysis for this event predicted the liner tear to be at the bottom of the pool for two leak sizes with a range of draindown times. This provided the boundary condition for the accident progression analysis. Please also see response to Comment #66.

**79) Comment:**

“Limited consideration of initiating events: The Study considers only one type of initiating event – an earthquake. That narrow focus reflects a pre-determined conclusion that earthquake is the dominant contributor to the risk of a pool fire.”

**NRC Response:**

The study is focused on an earthquake because it is the event shown by past studies to dominate spent fuel pool risk. (See NUREG-1353 and NUREG-1738)

**80) Comment:**

“No consideration of attack: The Study ignores the potential for an attack on a pool and/or adjacent reactor to initiate a pool fire. Yet, the probability of an attack with a substantial likelihood of success is at least equal to the probability of the severe earthquake that the Study does consider. Thus, the Study significantly under-estimates pool-fire risk.”

**NRC Response:**

Please see NRC response to Comment #17

**81) Comment:**

“No analysis of risk linkages among pools and reactors: The Study identifies the potential for risk linkages, but does not properly analyze them. For example, the Study does not analyze a situation in which onsite radioactive contamination and other impacts of a reactor core melt would preclude mitigating actions that might prevent a pool fire. Yet, the probability of a core melt at an adjacent reactor is at least equal to the probability of the severe earthquake that the Study does consider. Thus, the Study significantly under-estimates pool-fire risk.”

**NRC Response:**

The possibility that a concurrent reactor event may preclude operator actions is part of the motivation for the "unmitigated" cases analyzed in the study. Section 9.4 presents sensitivity calculations to show the importance of the reactor building in the progression of accidents in the SFP and the source term from a concurrent reactor accident. More explicit treatment of multi-unit issues between SFPs and reactors is being pursued under the NRC's comprehensive site Level 3 PRA project discussed in SECY-11-0089. The NRC staff does not agree that the study significantly under-estimates pool-fire risk.

**82) Comment:**

“Misleading statements regarding mitigating actions: The Study concedes that its analysis of the feasibility of mitigating actions is very limited. Yet, the Study makes unequivocal statements about this feasibility. Some of those statements are misleading, and reflect pre-determined conclusions.”

**NRC Response:**

The NRC staff had no intention of making misleading statements regarding the feasibility of mitigating actions. The uncertainty with the feasibility of mitigating actions is part of the motivation for the “unmitigated” cases analyzed in the study. The study reports in Section 6 both “mitigated” and “unmitigated” scenarios to show the effectiveness of mitigation. The assumptions regarding mitigation are discussed in Section 5.3 and Section 5.3.2 details the rationale for reporting the unmitigated results. The study treats situations where deployment of mitigation is either successful or not successful, considering only portable pumping equipment since the study assumes that the normal ac-powered systems are likely to be unavailable. As Chapter 8 explains, the Human Reliability Analysis (HRA) studies the human performance elements of mitigation along with binning scenarios based on ac and dc power assumptions. But the HRA does not include a system failure analysis for the equipment (such as water tanks or the fire header). These types of failures are subsumed by the cases without successful deployment of mitigation.

**83) Comment:**

“In the Study, NRC employs the MELCOR code to model phenomena related to a pool fire – including heat transfer, cladding ignition, and fire dynamics. MELCOR findings are significant to NRC’s estimation of pool-fire risk. Yet, the validity of MELCOR in this context, and the appropriateness of NRC’s input assumptions, have not been tested through a process of open scientific inquiry. There are significant issues that should be addressed through such a process, including MELCOR’s simplified treatment of radiative heat transfer.”

**NRC Response:**

This response discusses both the validity of the MELCOR code for SFP analysis, and some of the input assumptions and results of the accident progression in the reviewer detailed comments (see ADAMS Accession No. [ML13225A397](#)) .

MELCOR is the most widely-used regulatory severe accident code in the world. It represents the current state of the art in severe accident analysis, and has been developed through NRC and international research performed over the past three decades. In addition to domestic use, the code is provided by NRC to international organizations through bilateral agreements under the Cooperative Severe Accident Research Program (CSARP).

MELCOR has been benchmarked against many experiments including separate and integral effects tests for a wide range of phenomena. Any new application of MELCOR requires targeted assessment of the code. The SFP models in MELCOR have been developed over the past 10 years, and are supported by experimental validation. The air oxidation kinetics models in MELCOR for zirconium-based alloys (including Zirlo and M5) are based on the research sponsored by NRC and documented in NUREG/CR-6846. The MELCOR model does not make assumptions about the temperature at which a zirconium fire is initiated, but rather relies on experimental data (see Section 6.1.1) to correlate the timing of breakaway oxidation. The generalized thermal radiation model (between any groups of assemblies modeled as individual rings) was developed to have flexibility in the modeling of the spent fuel assemblies, so no need exists for the assumption of a “cylindrical” geometry. MELCOR provides a best estimate prediction of fuel heat up considering all the heat transfer mechanisms such as radial radiation between assemblies, convective cooling by steam and

air, radiation and convective heat transfer to the pool liner, and heat transfer from the exposed fuel assemblies to an underlying water pool.

MELCOR was used in the zirconium fire experiments (see NUREG/CR-7143) and the predictions showed good agreement with data for the initiation and propagation of zirconium fire. The publication of experimental results in NUREG/CR-7143 (including code to code comparisons) as well as the present study and review by the Advisory Committee on Reactor Safeguards supports the adequacy of MELCOR's use for this purpose.

The main focus of the present report was on progression of severe accidents following a loss of coolant inventory in a SFP, resulting in high temperature oxidation of cladding (and in some instances large scale melting and relocation of the assemblies) and associated release of fission products. Uncertainties in modeling of the accident progression (e.g., hydrogen combustion, radiative heat transfer) have been considered as part of sensitivity studies showing a range of fission product release. The model limitations (e.g., lack of a cladding deformation model) are documented in the report. In some instances, these limitations are not expected to change the results significantly. For example, in OCP3, the code calculates large scale zirconium fire and fuel degradation, and release from the fuel. However, in OCP4, temperatures remain below 700 C (see Figures 52-55 in the report reproduced as Figures VII-2 and VII-3 by the reviewer).

For the layout of the assemblies in the pool (see Figure 44 in the report reproduced as Figure VII-1 by the reviewer), this is a stylized assumption regarding the 1x4 loading pattern for both the high density and low density pool to compare the consequences. In fact, as stated in the report, the reference plant employs a 1x8 arrangement. This is a valid assumption since there is relatively less variation in the decay heat of the older assemblies and it was appropriate to group all the older assemblies in a few computational rings since the risk from the zirconium fire is dominated by the hot fuel. For the study, individual assembly data were provided by the licensee that were subsequently used for an inventory calculation using the computer code SCALE. The breaking up of the freshly discharged fuel (284 assemblies) into two rings was to account for the variations in decay heat of the individual assemblies with different burnups based on the actual assembly data as discussed in Section 6.1.5. The calculations in the present report were for a specific SFP with pre-arranged fuel loading pattern. This fact is acknowledged in the report in Table 15 and in Section 9.3. Even though the specific time requirement for achieving the 1x4 arrangement is not publicly available information, the sensitivity calculations presented in Section 9.3 show that somewhat higher releases are expected in OCP1 and OCP2 for a contiguous fuel pattern, and the large releases for 1x4 in OCP3 are comparable to OCP2. The objective of this study was not to provide a detailed analyses for spent fuel pools, but to provide a detailed accident progression analysis for a specific pool with additional sensitivity calculations to offer insights on releases from different loading patterns.

**84) Comment:**

“In the Study, NRC has erected an elaborate superstructure of analysis on a weak foundation of basic knowledge about pool-fire phenomena. This superstructure culminates in a regulatory analysis. As discussed in paragraph VIII-2, above, the findings emanating from this superstructure lack scientific credibility and are misleading. Thus, the design of the Study is fundamentally and irredeemably flawed.”

**NRC Response:**

As summarized in Chapter 1 of the report, the NRC has been studying SFP risk for many years, including the performance of zirconium fire experiments and MELCOR benchmarking (NUREG/CR-7143). The NRC team conducting the study included senior engineers in each of the key technical areas (seismic, structural, severe accident, consequence analysis, and probabilistic considerations).

The statements above that the study lacks “scientific credibility” and that its design is “fundamentally and irredeemably flawed: are not supported by the Advisory Committee on Reactor Safeguards (ACRS), which the NRC views as an independent body. In the ACRS letter recommending that the study be published (ML13198A433), the ACRS stated in part:

- The SFPS has been performed in a thorough and systematic manner, and provides a state-of-the-practice assessment of the consequences of a beyond-design-basis seismic event on the spent fuel pool in a reference boiling water reactor containing either high-density or low-density fuel loading.
- The SFPS provides sound approaches, tools, and insights for a broader evaluation of the consequences of severe seismic events on spent fuel pools of different design and will be valuable in determining whether expedited transfers to dry cask storage systems (DCSSs) produce substantial safety benefit for U.S. BWRs and PWRs.

**85) Comment:**

“The Study addresses an issue that is significant in terms of public health and safety. This significance is illustrated by the Study’s finding that a pool fire could lead to long-term displacement from their homes of more than 4 million people. Thus, citizens deserve a much better analysis of pool-fire risk than the incomplete, misleading work presented in NRC’s Draft Consequence Study.”

**NRC Response:**

The possibility of a zirconium fire does not contradict a finding of low risk. Risk is the product of likelihood and consequence, and can only be evaluated by considering both of these components. Moreover, the potential that beyond design-basis events might lead to a radiological release does not contradict a finding of reasonable assurance of adequate protection.

Five Japanese nuclear power plant sites with a combined total of 20 reactors and 20 SFPs were subjected to severe ground motions from two major earthquakes in the past 6 years (i.e., March 11, 2011 Tohoku and July 16, 2007 Niigataken Chuetsu-Oki earthquakes). The

operators of these 20 SFPs reported no water leakage from the pools after these earthquakes.

**86) Comment:**

NRC's Draft Consequence Study should be scrapped.

**NRC Response:**

See response to Comment 84.

**87) Comment:**

"In addressing the pool-fire issue, NRC should focus its initial attention exclusively on establishing a solid technical understanding of phenomena directly related to a potential pool fire. To do this, NRC would start with a clean slate and use the best available modeling capability backed up by experiment. This modeling and experimental work would be done according to scientific principles."

**NRC Response:**

Starting with a "clean slate" would ignore 35 years of accrued knowledge as summarized in Chapter 1 of the report. Please also see the response to Comment #83.

**88) Comment:**

"the Study proceeds to make unequivocal statements about the feasibility of mitigation. For example, in addressing the potential for a boil-off scenario of water loss, the Study says that the probability of mitigation failure extending for 7 days is "negligible".<sup>43</sup> That statement is based on no analysis, and reflects a pre-determined conclusion. NRC ignores, for example, the possibility that radiation fields and other onsite impacts of a reactor core melt could preclude mitigation for an extended period."

Footnote 43: Barto et al, 2013, page 175.

**NRC Response:**

The study analyzed scenarios with and without successful deployment of mitigation that reasonably characterizes the range of possibilities. Please also see the NRC response to Comment #6